



AQtap

water dispenser



**INSTALLATION
GUIDE**

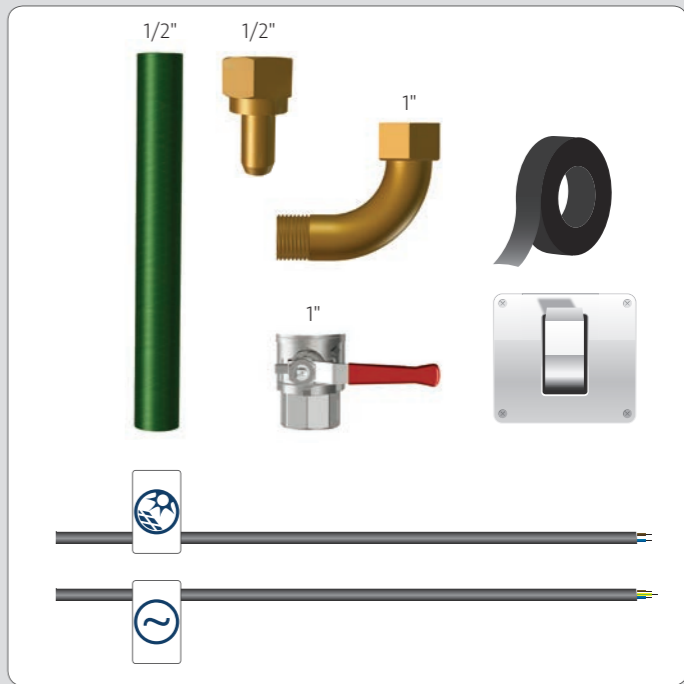
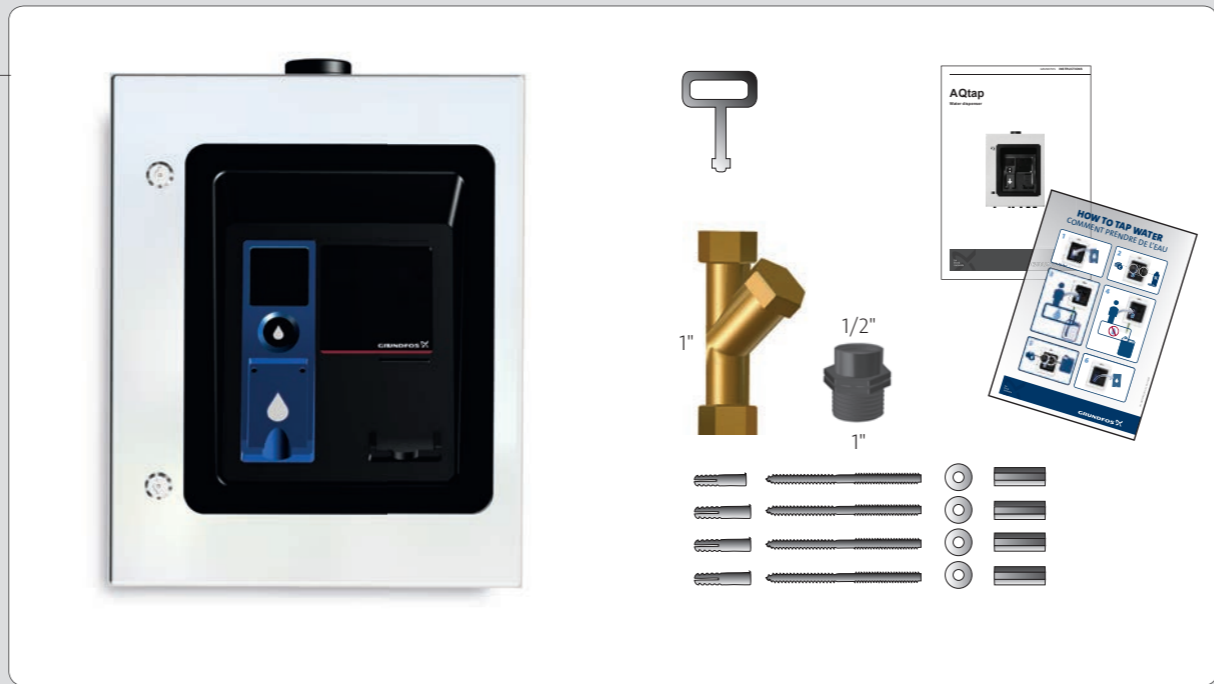

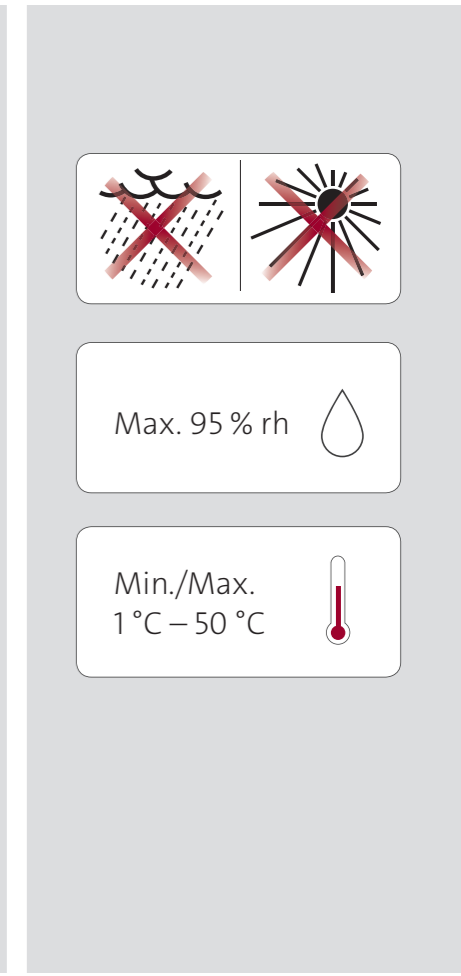
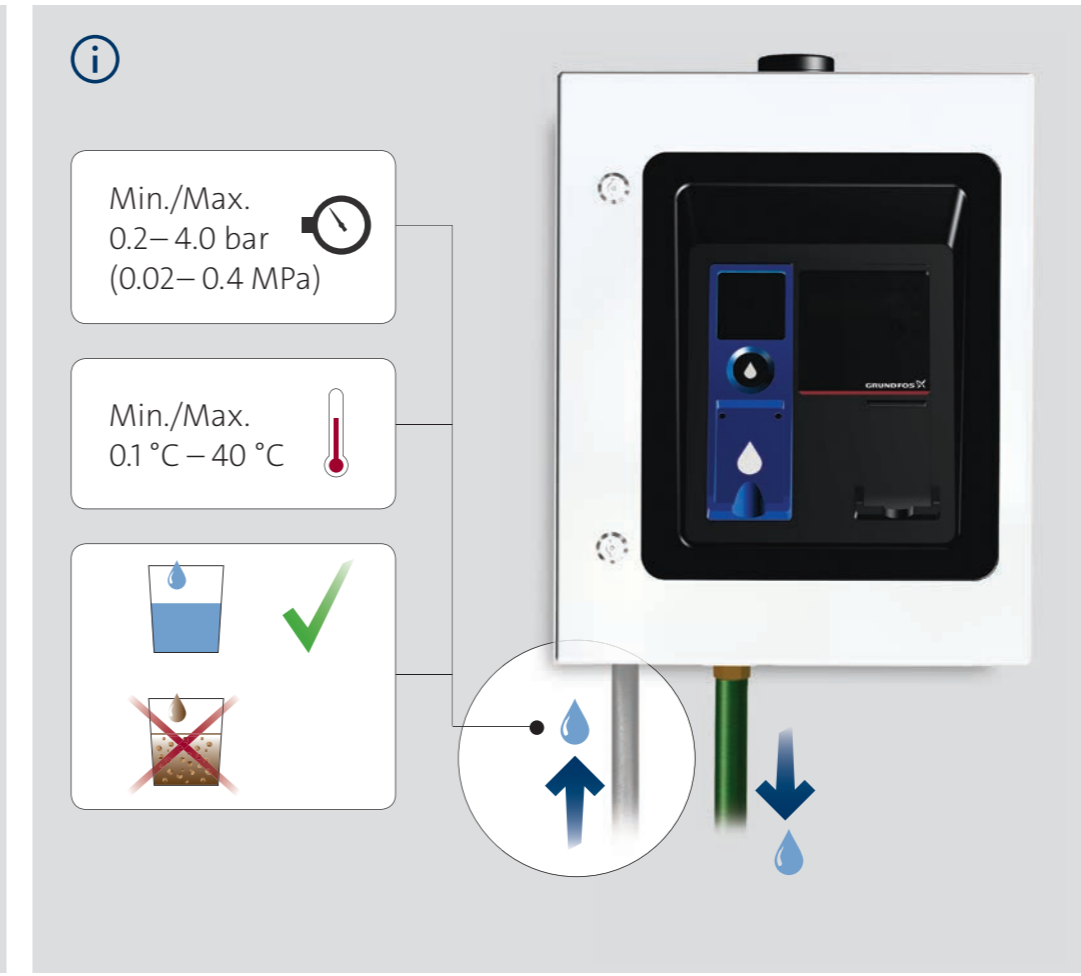
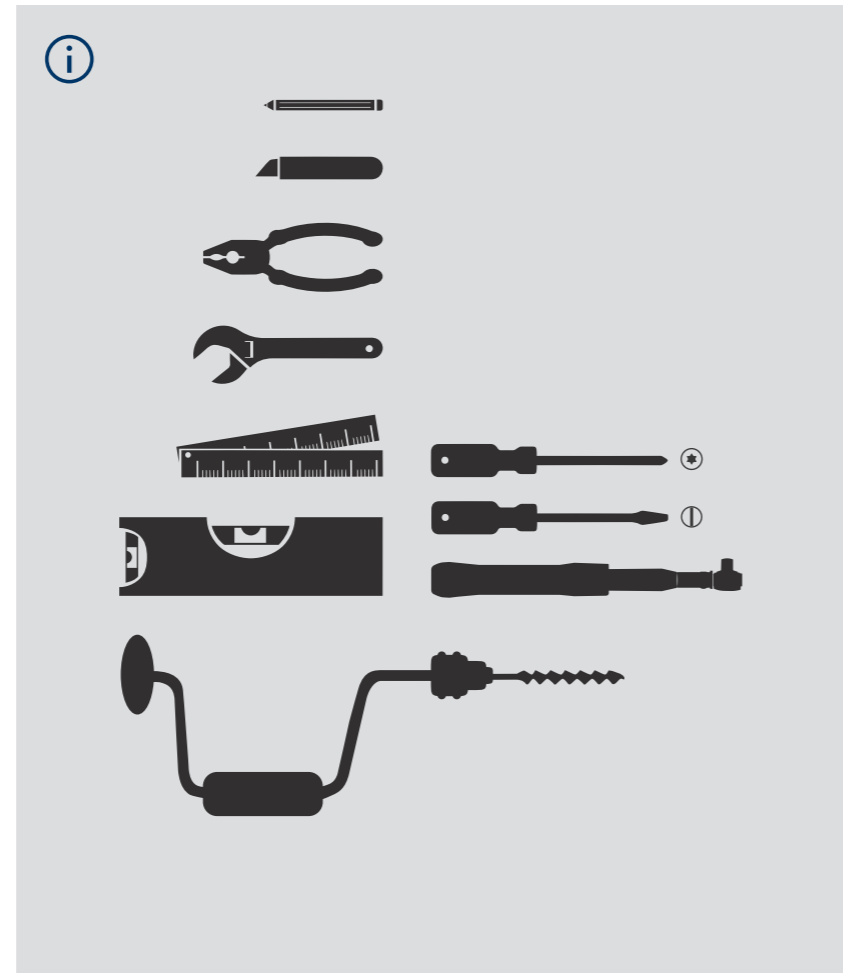
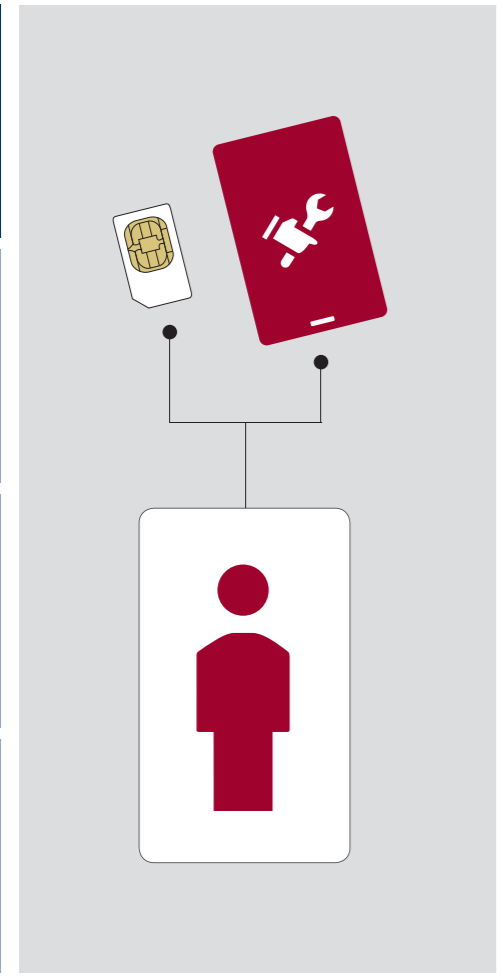

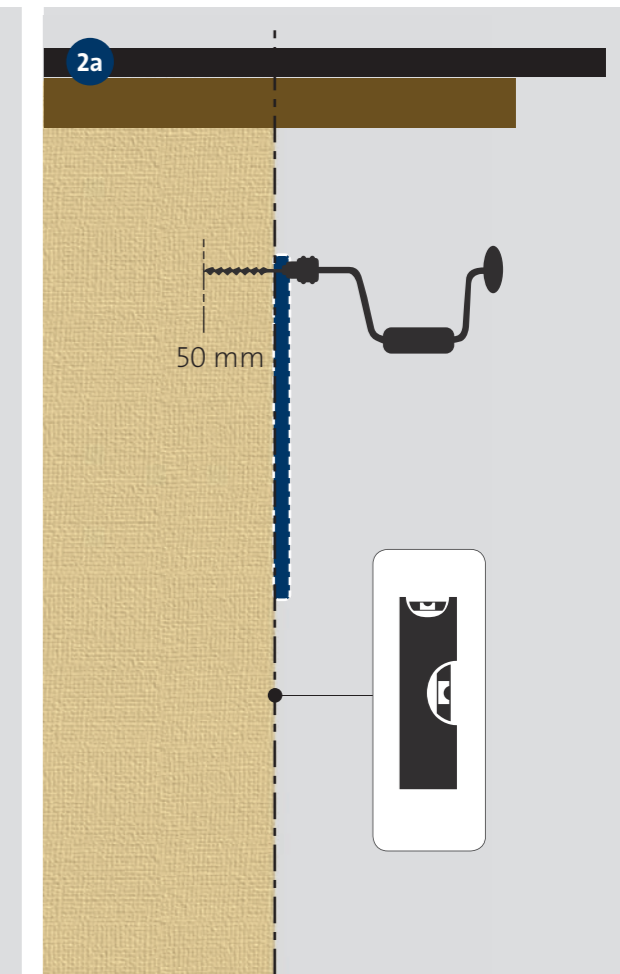
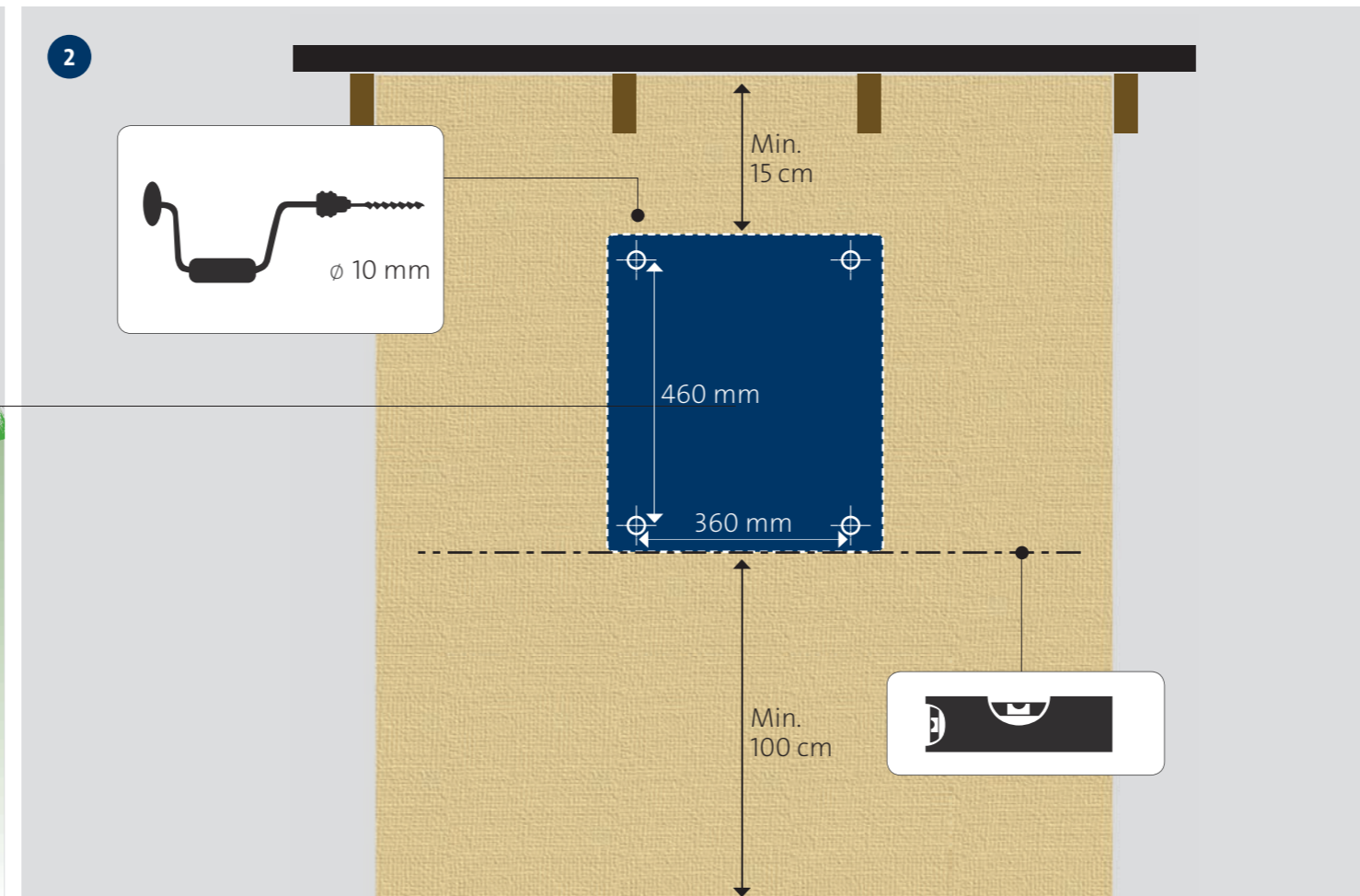
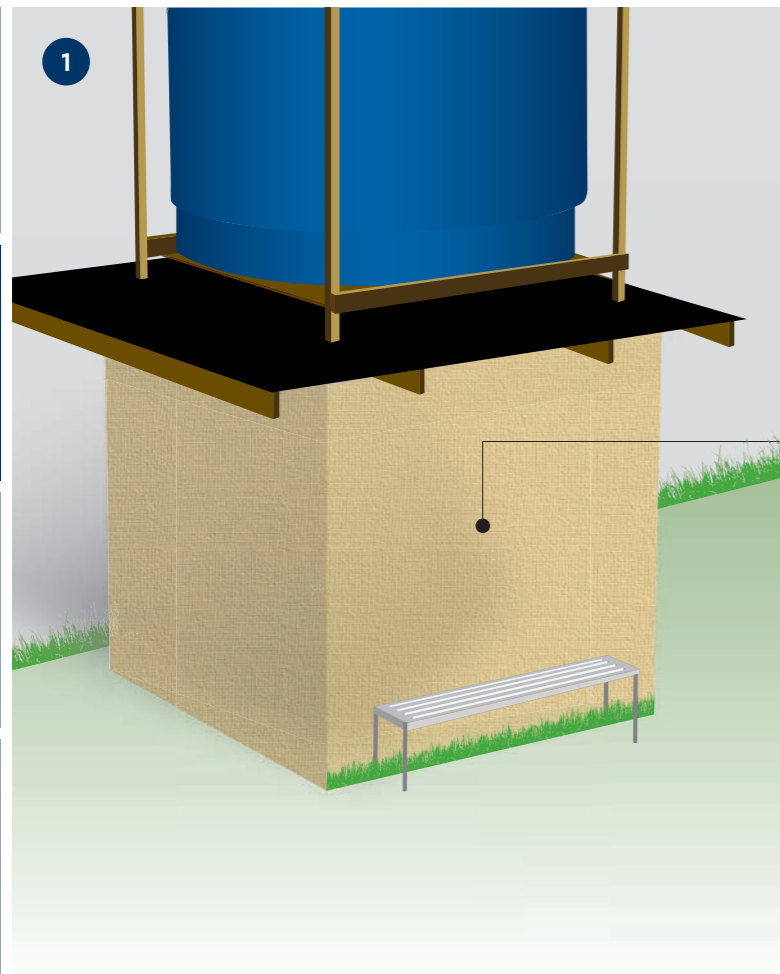

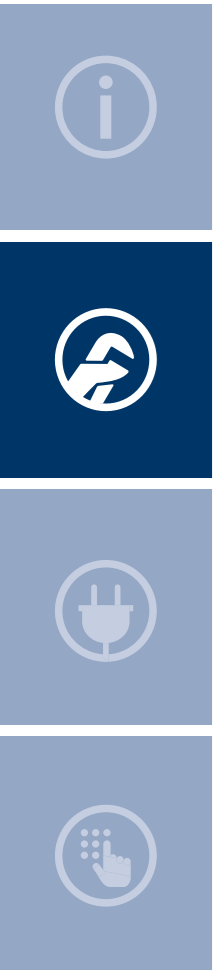

3

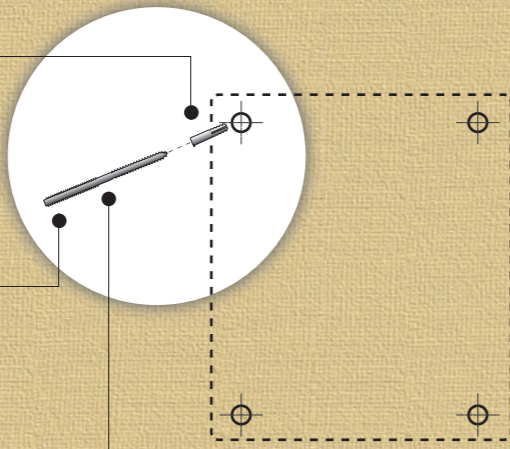
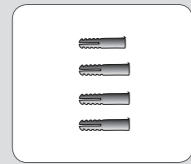

4



5

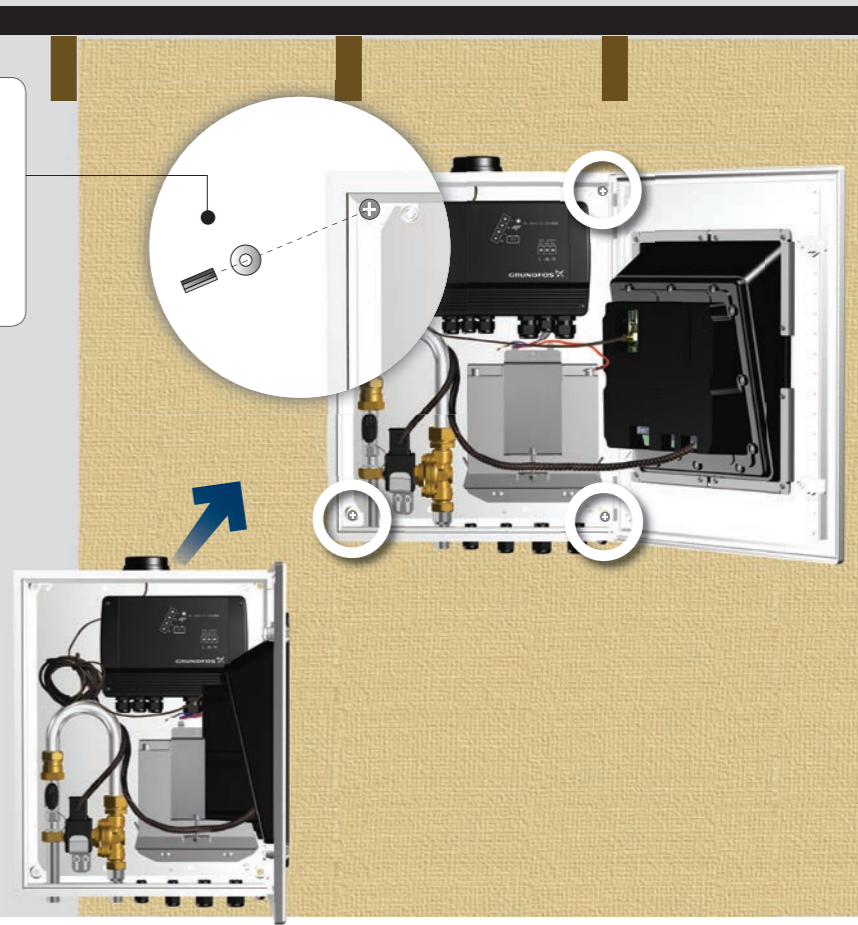
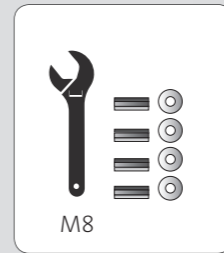



6

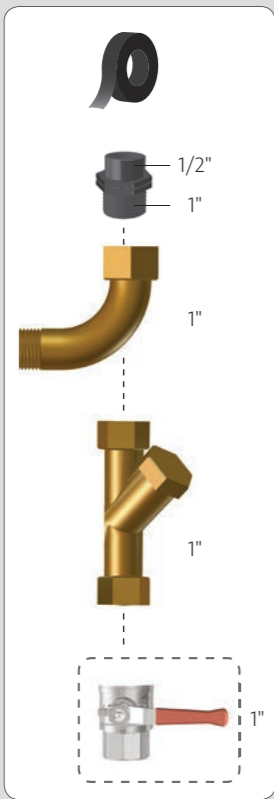

7



10+/- 1 Nm

30+/- 3 Nm



8

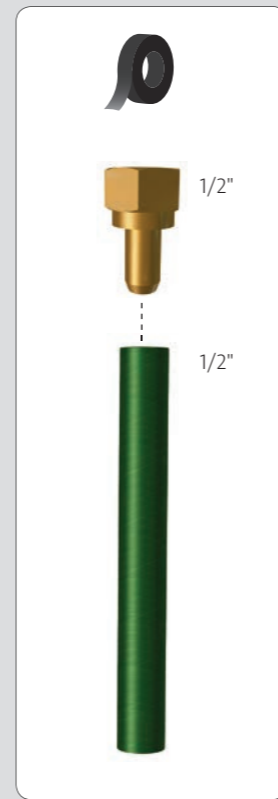

9

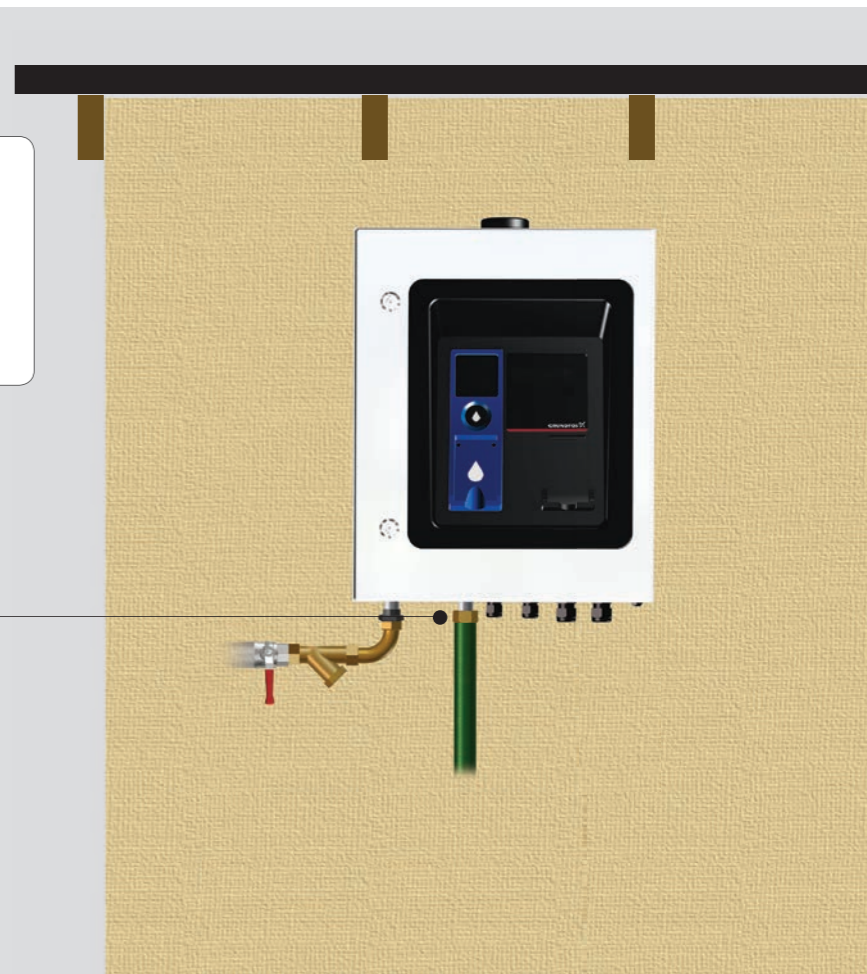

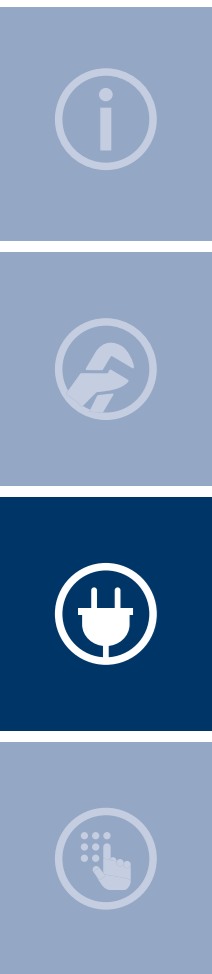

10



11

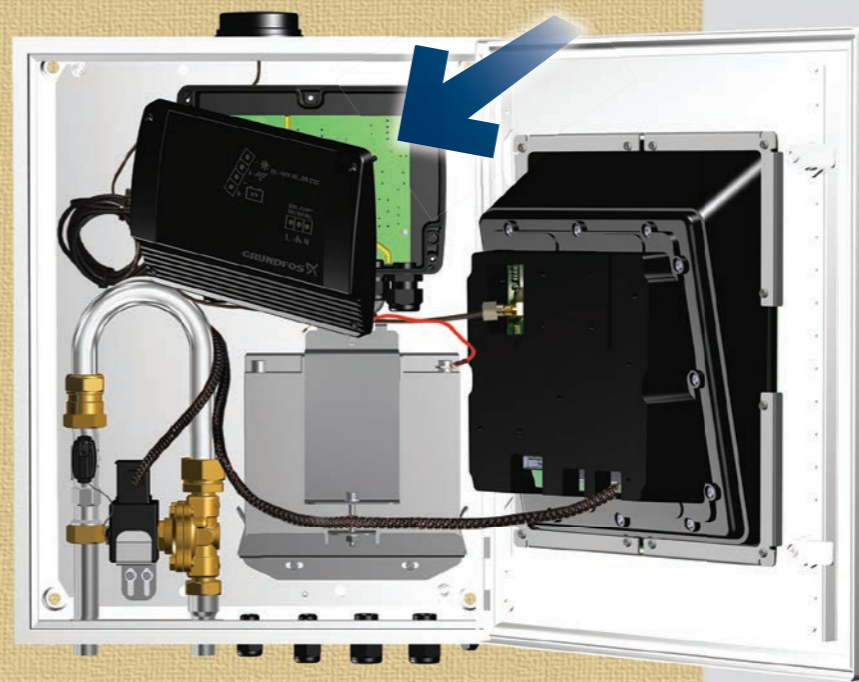
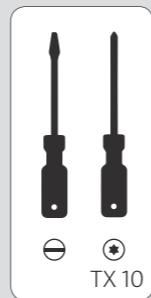

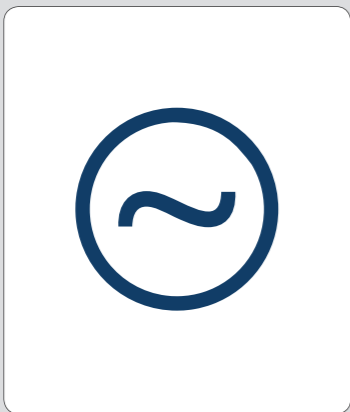

12a



50/60 Hz

7 mm I Min./Max. 0.75/2.5 mm²

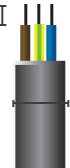

Min. Ø 7 mm
Max. Ø 12 mm

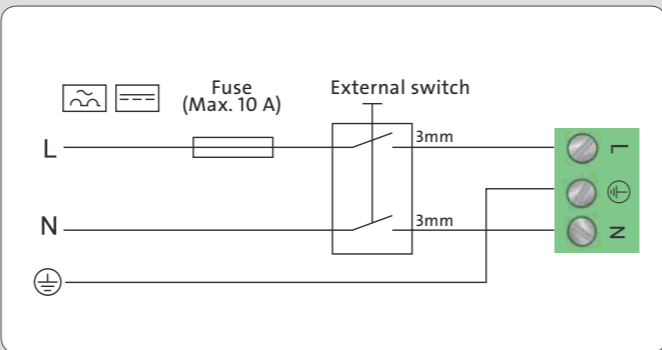

13a

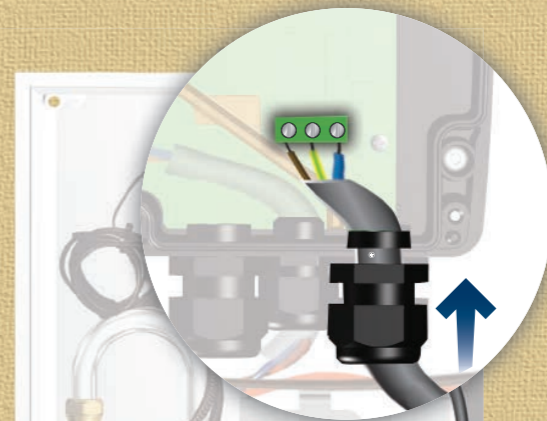

14a

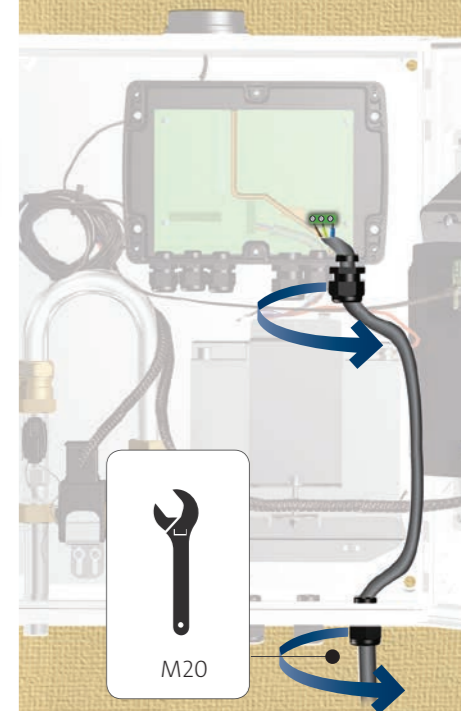



12b



VDC, Max. 3A

7 mm I I Min./Max. 0.75/2.5 mm²



Min. Ø 7 mm
Max. Ø 12 mm

13b

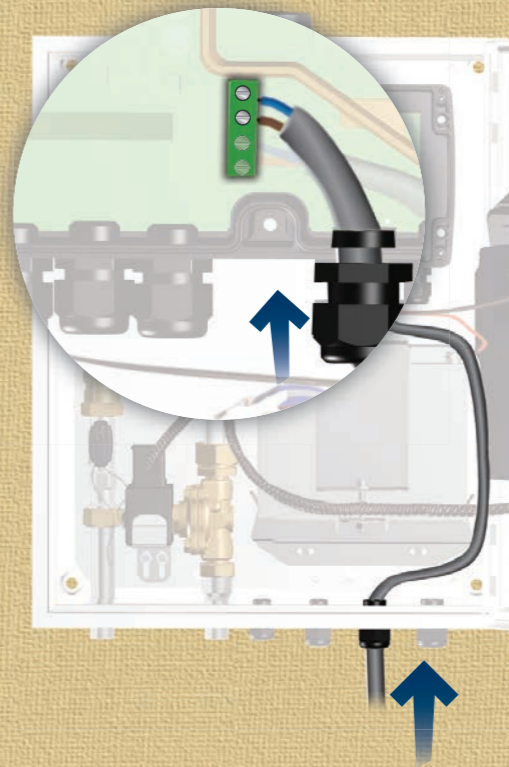
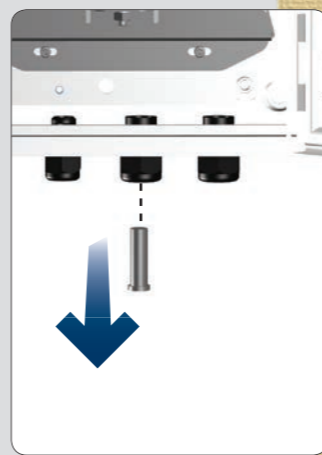

14b

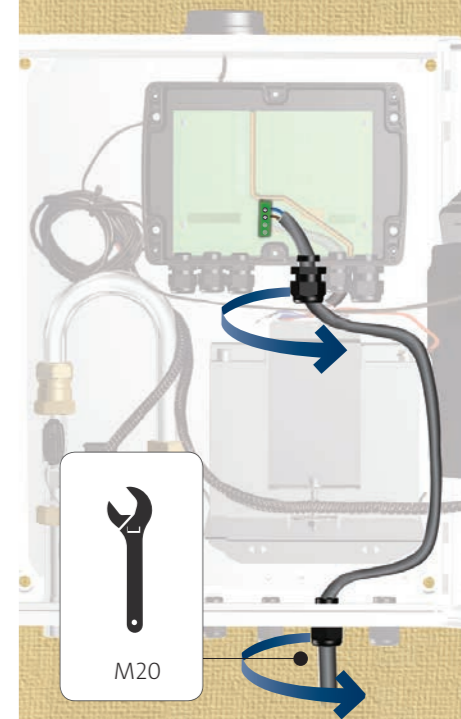



15



TX 25
0.8 Nm

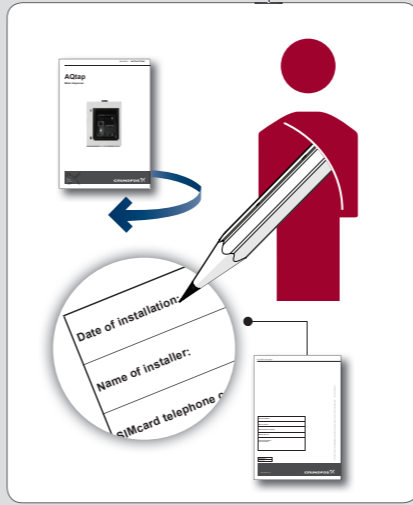
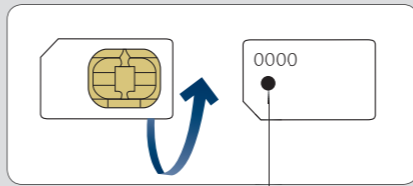

16

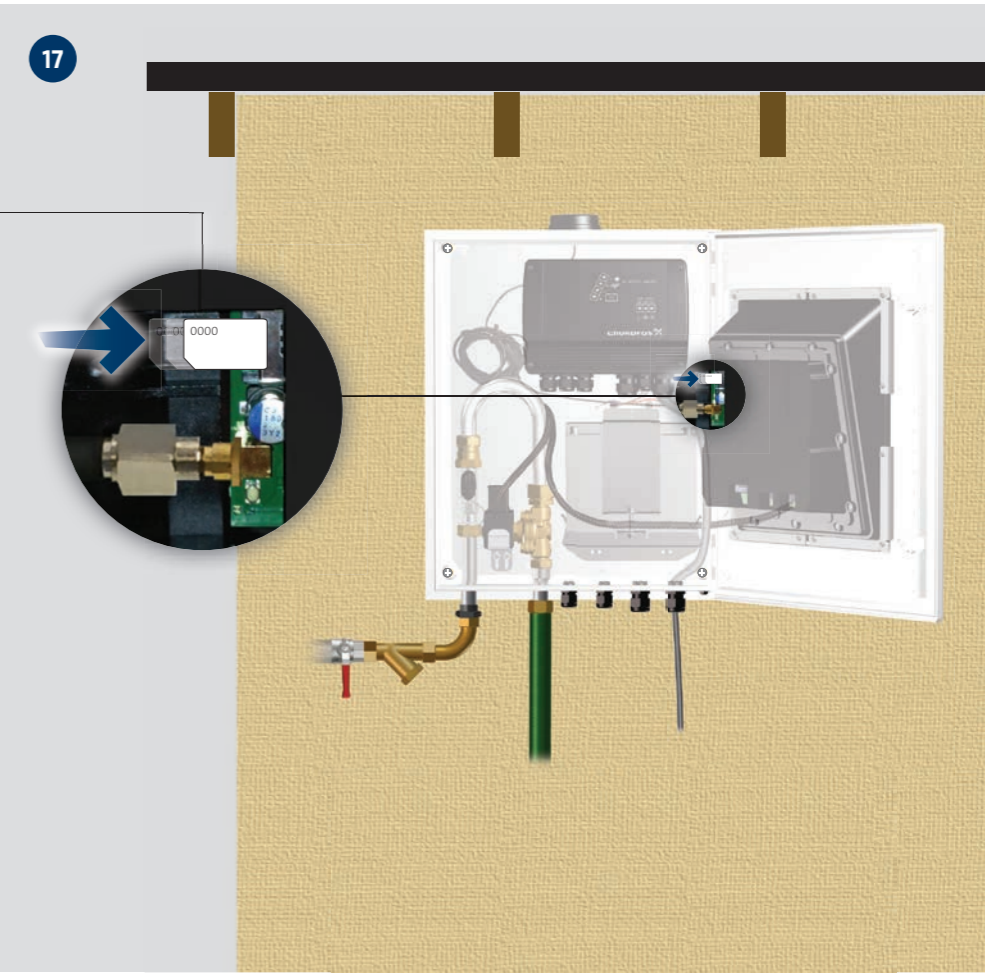

17



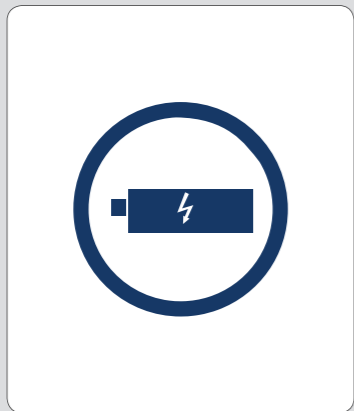
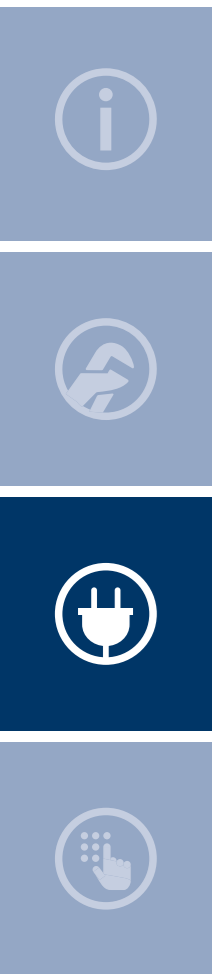

18



12V lead acid

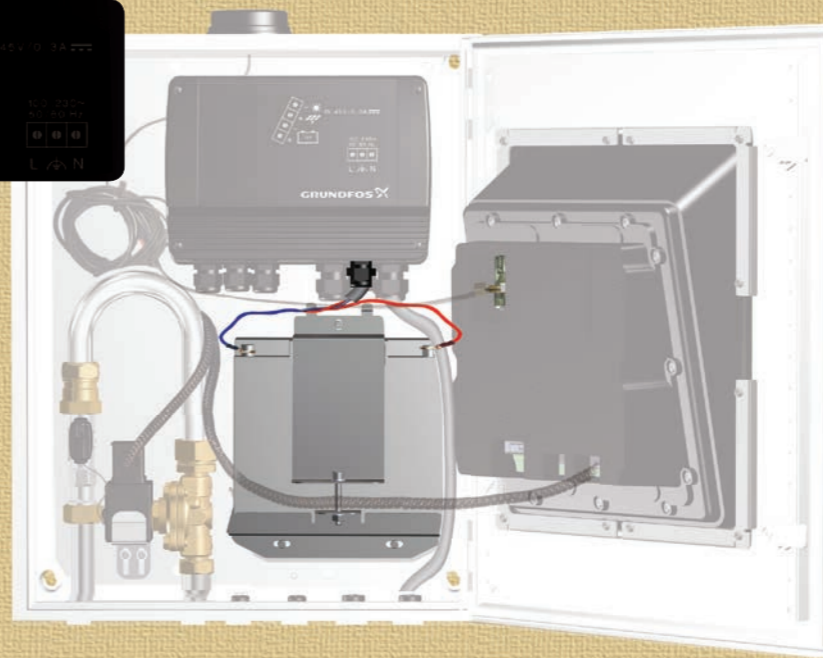
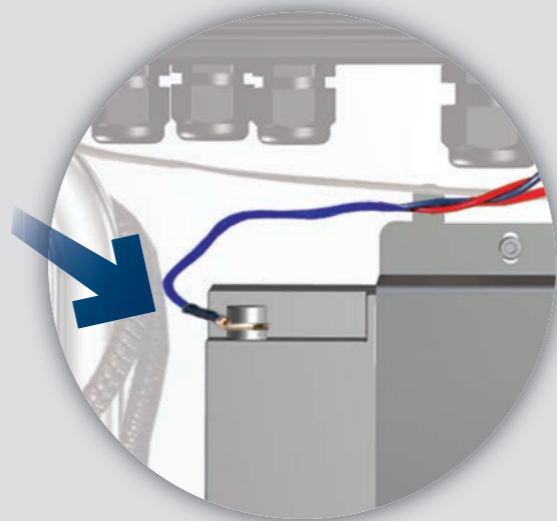



19

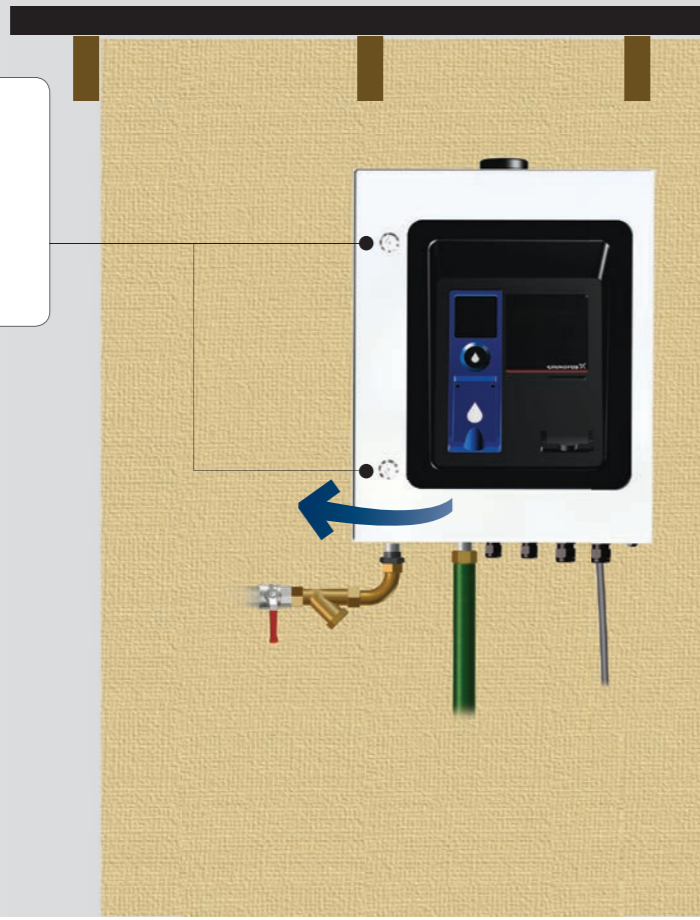
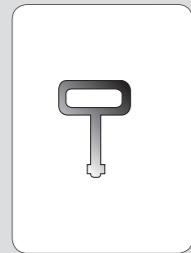

20



21

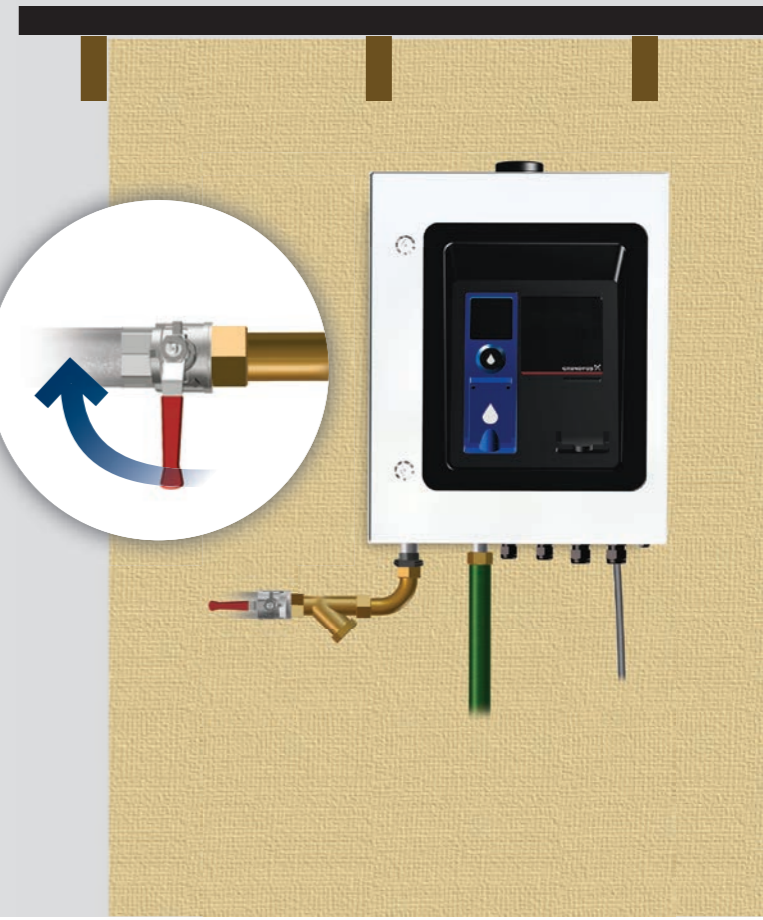
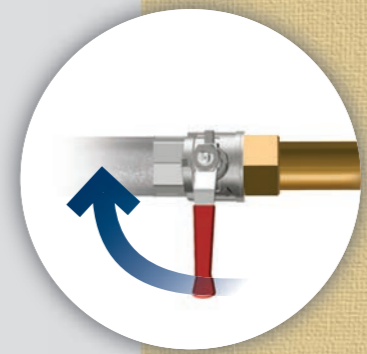

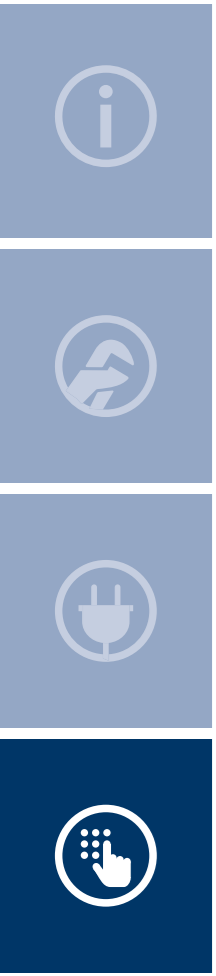

26

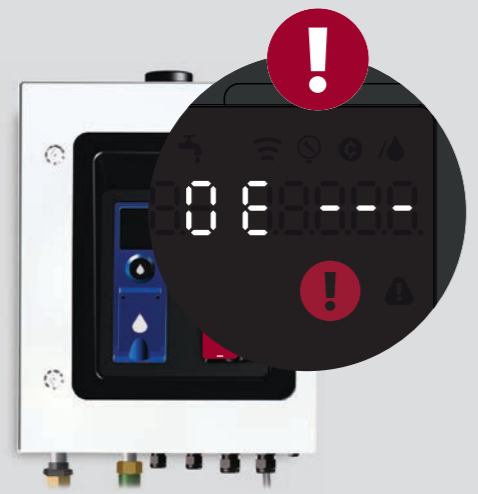

! ---
= No alarms



27

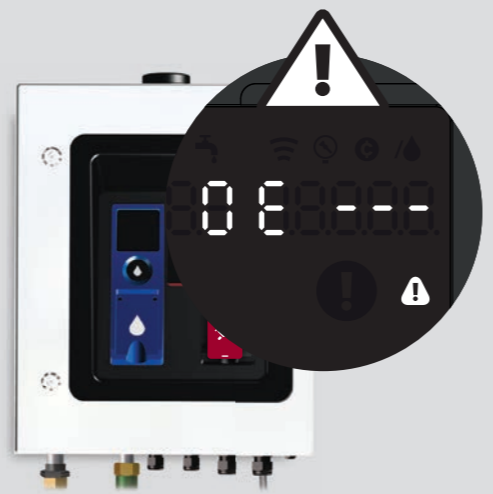

! ---
= No warnings



28



1L = [up/down arrows] Set waterprice



29

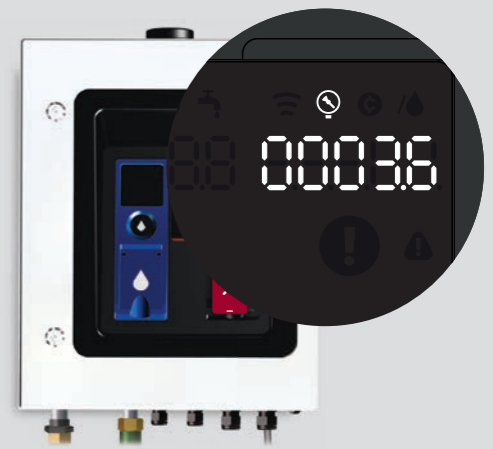

Static water pressure



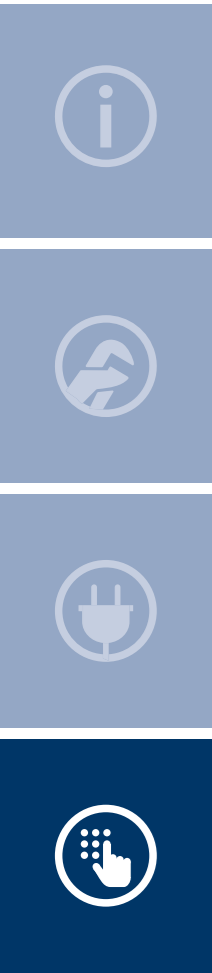

30



31



32

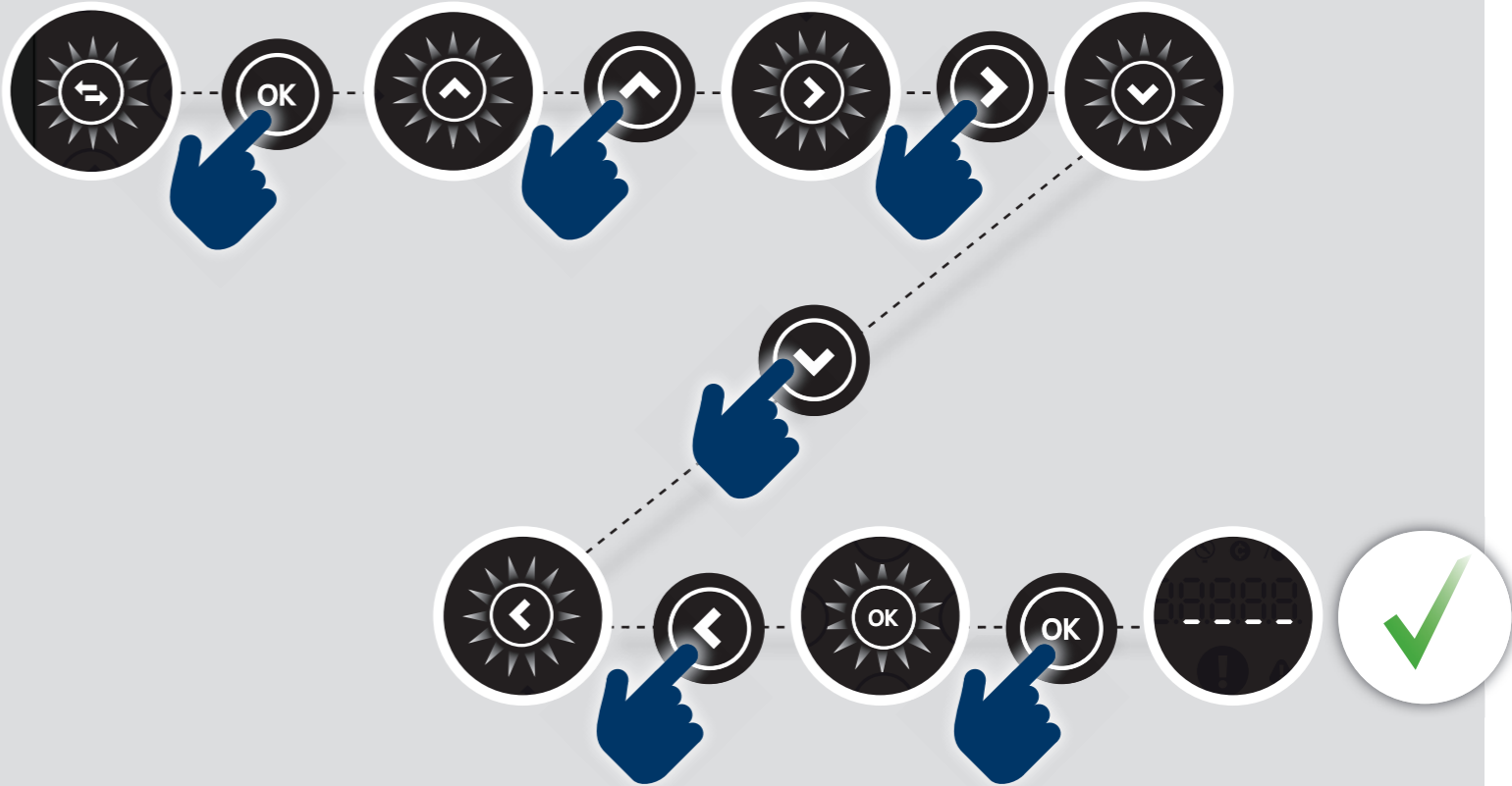

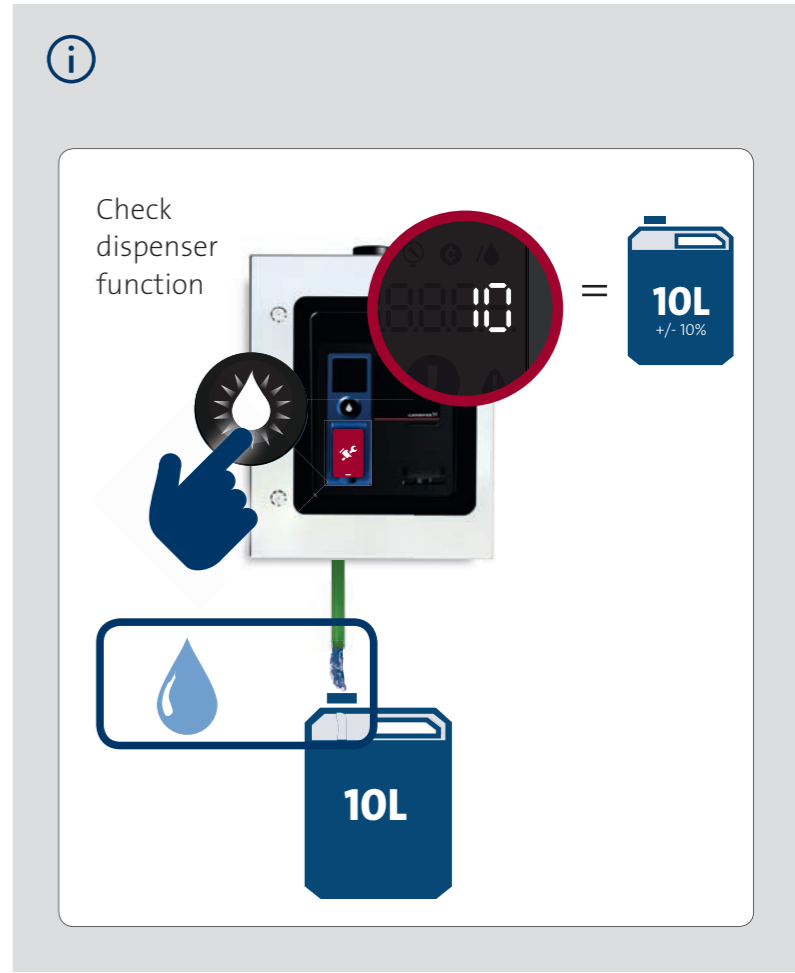
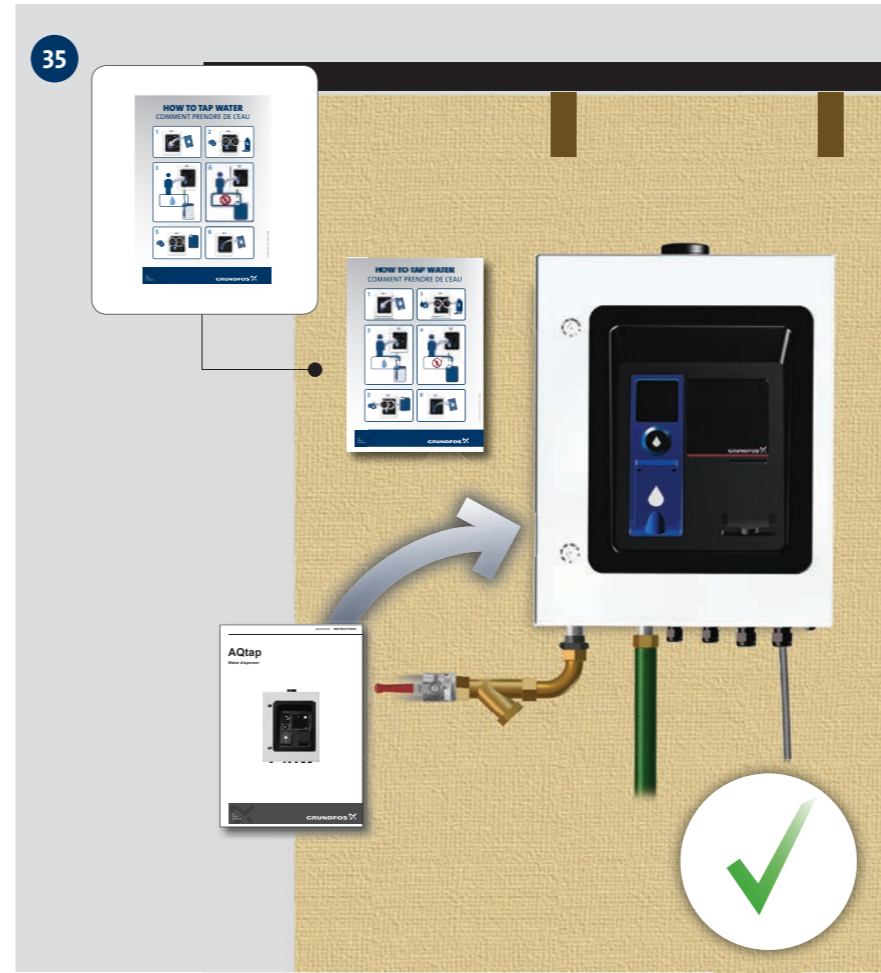
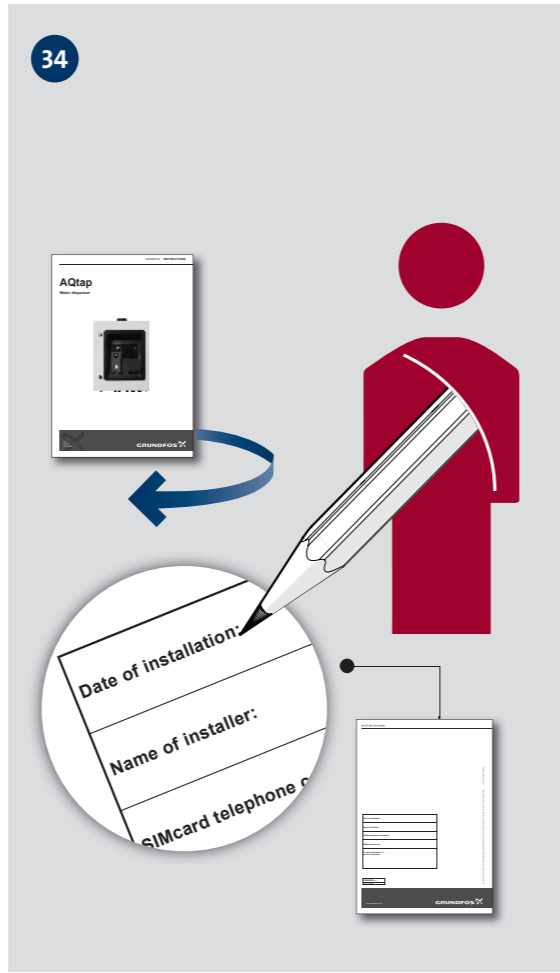
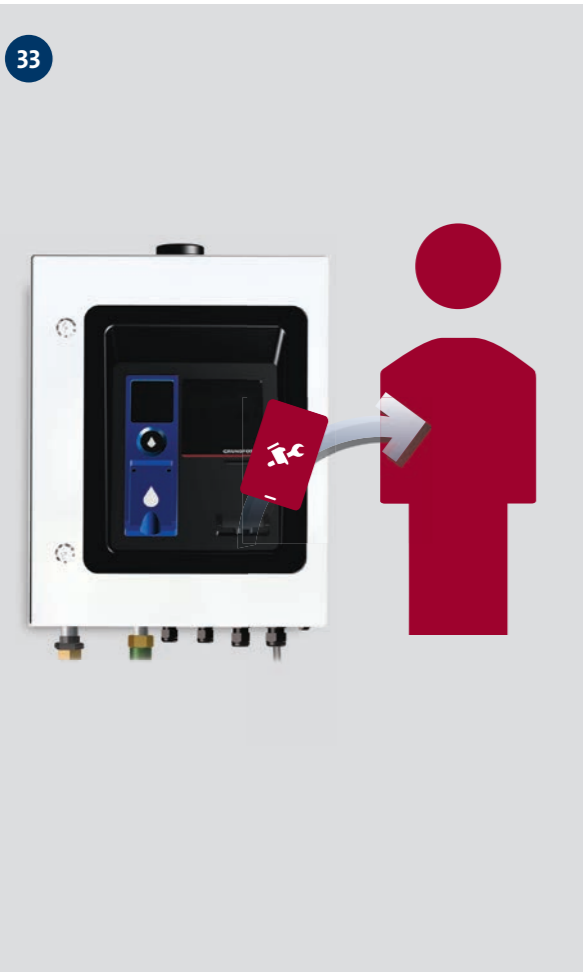
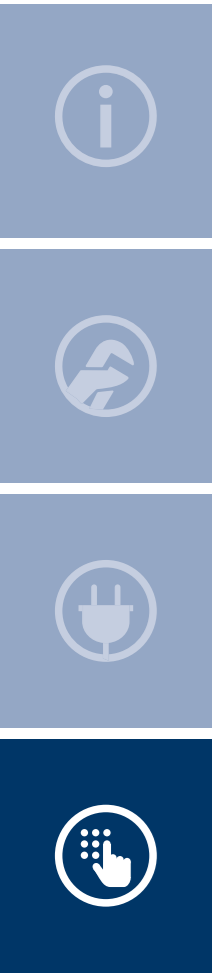

GRUNDFOS Holding A/S

Poul Due Jensens Vej 7
DK-8850 Bjerringbro
Tlf.: +45-87 50 14 00

98772039 0517

ECM: 1199668

be think innovate

GRUNDFOS 

The name Grundfos, the Grundfos logo, and the payoff be think innovate are registered trademarks owned by Grundfos Holding A/S or Grundfos A/S, Denmark. All rights reserved worldwide.