

# Flow sensors







Grundfos Direct Sensors™



<b>1. Product overview</b> .....	<b>3</b>	<b>8. Accessories</b> .....	<b>76</b>
<b>2. Product introduction</b> .....	<b>4</b>	Sensor interface, converter unit .....	76
Vortex principle .....	4	M12 cable .....	76
Construction .....	4	Snap-on cable .....	76
Material .....	4	<b>9. Appendix</b> .....	<b>77</b>
Definitions .....	4	Pressure drop curves .....	77
Type key .....	5	Installation of VFI sensors .....	79
<b>3. Vortex Flow sensor, Industry (VFI and VFI+T2)</b> .....	<b>8</b>	Intended use for pressurised systems .....	80
General data .....	8	<b>10. Grundfos Product Center</b> .....	<b>81</b>
VFI and VFI+T2, 0.3 - 6 m <sup>3</sup> /h (1.3 - 26.4 gpm) . . .	10		
VFI and VFI+T2, 0.6 - 12 m <sup>3</sup> /h (2.6 - 52.8 gpm) . .	12		
VFI and VFI+T2, 1.3 - 25 m <sup>3</sup> /h (5.7 - 110 gpm) . . .	14		
VFI and VFI+T2, 2-40 m <sup>3</sup> /h (8.8 - 176 gpm) . . . . .	16		
VFI and VFI+T2, 3.2 - 64 m <sup>3</sup> /h (14-282 gpm) . . . .	18		
VFI and VFI+T2, 5.2 - 104 m <sup>3</sup> /h (23-458 gpm) . . .	20		
VFI and VFI+T2, 8-160 m <sup>3</sup> /h (35-704 gpm) . . . . .	22		
VFI and VFI+T2, 12-240 m <sup>3</sup> /h (53-1057 gpm) . . . .	24		
<b>4. Vortex Flow sensor, Standard (VFS and VFS QT)</b> .....	<b>26</b>		
General data .....	26		
VFS, 1-20 l/min (0.3 - 5.3 gpm) .....	28		
VFS, 2-40 l/min (0.5 - 10.6 gpm) .....	30		
VFS, 5-100 l/min (1.3 - 26 gpm) .....	32		
VFS, 10-200 l/min (2.6 - 53 gpm) .....	34		
VFS, 20-400 l/min (5.3 - 106 gpm) .....	36		
VFS QT, 0.5 - 10 l/min (0.13 - 2.6 gpm) .....	38		
VFS QT, 1-18 l/min (0.3 - 4.8 gpm) .....	40		
VFS QT, 2-40 l/min (0.5 - 10.6 gpm) .....	42		
VFS QT, 5-100 l/min (1.3 - 26 gpm) .....	44		
VFS QT, 10-200 l/min (2.6 - 53 gpm) .....	46		
<b>5. Multi Flow sensor, Standard (MFS and MFS QT)</b> .....	<b>48</b>		
General data .....	48		
MFS 2-20 l/min (0.53 - 5.3 gpm) .....	50		
MFS 4-40 l/min (1.06 - 10.6 gpm) .....	52		
MFS 10-100 l/min (2.6 - 26 gpm) .....	54		
MFS 20-200 l/min (5.3 - 53 gpm) .....	56		
MFS 40-400 l/min (10.6 - 106 gpm) .....	58		
MFS QT 2-18 l/min (0.39 - 4.8 gpm) .....	60		
MFS QT 4-40 l/min (1.06 - 10.6 gpm) .....	62		
MFS QT 10-100 l/min (2.6 - 26 gpm) .....	64		
MFS QT 20-200 l/min (5.3 - 53 gpm) .....	66		
<b>6. Integrated Temperature sensor Standard, ITS1</b> .....	<b>68</b>		
General data .....	68		
ITS1, 0-100 °C (32-212 °F) .....	70		
ITS1, -10 to +120 °C (14-248 °F) .....	72		
<b>7. Product range</b> .....	<b>74</b>		
VFI transmitters .....	74		
VFS and VFS QT sensors .....	75		

## 1. Product overview

This data booklet is for the latest version of Grundfos Direct Sensors™. Customers already buying Grundfos Direct Sensors™ might be buying a sensor with another specification.

Variant	Description	Technical data	
VFI 	Vortex Flow sensor, Industry. All stainless steel. Grundfos flanges or fittings.	Flow range: System pressure: Liquid temperature: Signal: Power supply: Enclosure class:	0.3 - 240 m <sup>3</sup> /h (1.3 - 1057 gpm) Maximum 30 bar (435 psig) -30 to +110 °C (-22 to +230 °F) 4-20 mA (2-wire) 12.5 - 30 VDC IP67
VFI+T 	Vortex Flow sensor, Industry. Combined flow and temperature measurement. Grundfos flanges or fittings.	Flow range: Temperature range: System pressure: Liquid temperature: Signal: Power supply: Enclosure class:	0.3 - 240 m <sup>3</sup> /h (1.3 - 1057 gpm) -10 to +120 °C (14-248 °F) Maximum 30 bar (435 psig) -30 to +110 °C (-22 to +230 °F) 2 x 0-10 V VDC (4-wire) 16.6 - 30 VDC IP67
VFS 	Vortex Flow sensor, Standard Combined flow and temperature measurement. Composite flow pipe.	Flow range: Temperature range: System pressure: Liquid temperature: Signal: Power supply: Enclosure class:	1.3 - 400 l/min (0.34 - 106 gpm) 0-120 °C (32-248 °F) Maximum 24 bar (348 psig) 0-100 °C (32-212 °F) Digital or analog communication (4-wire) 5 VDC (PELV) IP44
VFS QT 	Vortex Flow sensor, Standard QT. Combined flow and temperature measurement. Stainless-steel pipe with composite insert.	Flow range: Temperature range: System pressure: Liquid temperature: Signal: Power supply: Enclosure class:	1.3 - 200 l/min (0.34-53 gpm) 0-120 °C (32-248 °F) Maximum 30 bar (435 psig) 0-120 °C (32-248 °F) Digital or analog communication (4-wire) 5 VDC (PELV) IP44
MFS 	Multi Flow sensor, Standard Combined flow, pressure and temperature measurement. Output: two analog signals or proprietary digital bus for three signals (flow, temperature and pressure). Composite flow pipe.	Flow range: Temperature range: Pressure range: System pressure: Liquid temperature: Signal: Power supply: Enclosure class:	2 - 400 l/min (0.53 - 106 gpm) 0-120 °C (32-248 °F) 0-10 bar (0-145 psig) Maximum 24 bar (348 psig) 0-100 °C (32-212 °F) Digital or analog communication (4-wire) 5 VDC (PELV) IP44
MFS QT 	Multi Flow sensor, Standard QT Combined flow, pressure and temperature measurement. Output: two analog signals or proprietary digital bus for three signals (flow, temperature and pressure). Stainless-steel pipe with composite insert.	Flow range: Temperature range: Pressure range: System pressure: Liquid temperature: Signal: Power supply: Enclosure class:	2-200 l/min (0.53 - 53 gpm) 0-120 °C (32-248 °F) 0-10 bar (0-145 psig) Maximum 30 bar (435 psig) 0-120 °C (32-248 °F) Digital or analog communication(4-wire) 5 VDC (PELV) IP44
ITS1 	Integrated Temperature sensor, Standard Composite transmitter.	Temperature range: System pressure: Liquid temperature: Signal: Power supply: Enclosure class:	-10 to +120 °C (14-248 °F) Maximum 30 bar (435 psig) 100 °C (32-212 °F) 4-20 mA 12-30 VDC (PELV) IP54

## 2. Product introduction

This data booklet gives an overview of the Grundfos vortex flow sensor range and related products.

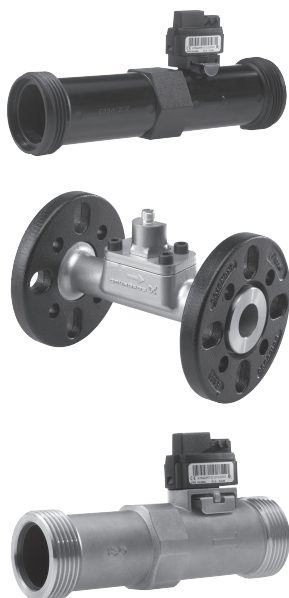

Grundfos vortex flow sensors

The Grundfos vortex flow sensor range comprises flow measurement systems as well as combined flow and temperature measurement systems (two-in-one) designed for harsh aqueous environments.

### Vortex principle

The flow measurement is based on the vortex principle. The system elements include a flow pipe with an integrated bluff body and a differential pressure sensor.

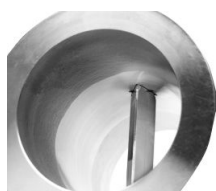

Bluff body inside a vortex flow sensor

When a bluff body is placed inside a pipe, a series of vortices will be generated on either side of the bluff body. These vortices propagate downstream, giving rise to periodic pressure variations which can be detected by the pressure sensor. The frequency of the pressure variations is proportional to the volume flow through the pipe.

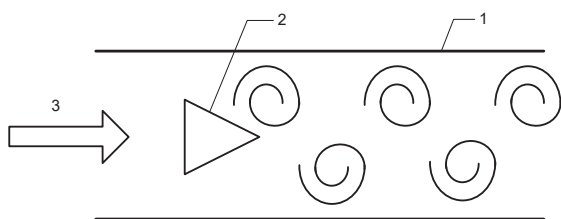

Operating principle

Pos.	Description
1	Pipe
2	Bluff body
3	Flow direction

The bluff body is designed to optimise the pulse strength of the pressure variations at the position of the differential pressure sensor.

Flow ranges are determined by the pipe diameter and the signal processing parameters. The differential pressure sensor key elements are a bulk micromachined silicon chip and a microprocessor-based signal-conditioning circuit, both on the same PCB. The conditioning circuit converts the pressure reading to a signal proportional to the flow.

### Construction

The bluff body is either integrated in the composite flow pipe, or supplied as a separate composite or stainless steel part to be inserted in the flow pipe.

The square chip membrane warps due to the pressure difference. This is registered as a change of resistance in the strain gauges of a Wheatstone bridge. The pressure and temperature sensitive area, the membrane region, is coated on both sides by an extremely corrosion- and diffusion-resistive thin film (Silicoat®). The coating makes the chip environmentally robust. The liquid-free zone is sealed by an O-ring.

### Material

The Grundfos vortex flow sensors are available in three material variants, suitable for different liquids:

- EPDM O-rings: Suitable for water; drinking-water approved.
- FKM O-rings: Suitable for oily liquids and water in heating applications.
- EPDM sealing sleeve with FKM O-rings: Suitable for water in heating applications with a high volume of calcium and magnetite.

### Definitions

#### Burst pressure

The maximum allowable pressure (relative to ambient) in a system, which will not destroy the sensor or transmitter. Measured in [bar].

#### Maximum system pressure

Maximum allowable static pressure (relative to ambient pressure) in a system, where the flow is zero.

TM078623

TM049236

TM047155

## Type key

This type key is common to all Grundfos Direct Sensors™ and thus not only specific to flow sensors.

Product type		
Example: VFS/---1-20I/5/Q/S-----/EG4/CB/03P/SW-1		
Pressure sensors:	Flow sensors:	
CPS: Combi Pressure sensor Digital	MFS: Multi Flow sensor Standard	
DPI: Differential Pressure sensor Industrial	VFD: Vortex Flow sensor Digital	
DPS: Differential Pressure sensor Standard	VFI: Vortex Flow sensor Industrial	
RPI: Relative Pressure sensor Industrial	VFS: Vortex Flow sensor Standard	
RPS: Relative Pressure sensor Standard		
Temperature sensors:		
ITS: Integrated Temperature sensor Standard		
Range		
Example: VFS/---1-20I/5/Q/S-----/EG4/CB/03P/SW-1		
Seven characters, some of them can be hyphens		
C: Configurable	M: Minus	
Unit		
Example: VFS/---1-20I/5/Q/S-----/EG4/CB/03P/SW-1		
Pressure	Temperature	Flow
b: bar	C: °C	l: litre/minute
p: psi		m: m <sup>3</sup> /h
Generation		
Example: VFS/---1-20I/5/Q/S-----/EG4/CB/03P/SW-1		
1: 1 <sup>st</sup> generation	2: 2 <sup>nd</sup> generation	3: 3 <sup>rd</sup> generation; and so on
Electrical output type		
Example: VFS/---1-20I/5/Q/S-----/EG4/CB/03P/SW-1		
C: 4-20 mA, 2 wires	1: Self-configuring Redwolf protocol / TTL (Uart) or 1 × 0.66-3.5 V and 1 × 0.5-4.1 V	
D: 2 × 0.5-3.5 V	3: Self-configuring Redwolf protocol / TTL (Uart) or 1 × 0.71-4.14 V and 1 × 0.5-4.1 V	
E: 2 × 0.5-4.5 V	4: Self-configuring Redwolf protocol / TTL (Uart) or 1 × 0.5-4.14 V and 1 × 0.5-4.1 V	
F: 2 × 0-10 V	5: Self-configuring Redwolf protocol / TTL (Uart) or 1 × 0.5-5.14 V and 1 × 0.5-4.1 V	
G: 4-20 mA, 3 wires	6: 1 × 0.42-3.5 V and 1 × 0.5-3.5 V	
I: V-bus protocol / Open-drain	7: 1 × 0.6-4.5 V and 1 × 5 V	
K: OEM protocol / TTL (open-drain) (Uart)	8: Self-configuring Redwolf protocol / TTL (Uart) or 1 × 0.5-3.5 V and 1 × 0.25-3.75 V (dry-run at 4.1 V)	
M: Redwolf protocol / TTL (Uart)	9: High side drive pulse output. Referenced to VCC. Flow only. 0 to 100 Hz on pin 2	
Q: Self-configuring Redwolf protocol / TTL (Uart) or 1 × 0.5-3.5 V and 1 × 0.5-4.1 V		
R: 1 × 0.5-3.5 V and 1 × 0.5-4.1 V		
S: Redwolf protocol / Open-drain		
Sensor connector or cable type and cable connector in sensor end		
Example: VFS/---1-20I/5/Q/S-----/EG4/CB/03P/SW-1		
A: Grundfos cover, 4-pin male	M: M12 × 1, female straight, shielded 4 wire cable	
D: FCI 90312-004LF/77138-101, over moulded, shielded 4 wire cable	N: M12 × 1, 4-pin male	
G: TE integrated, female, angled, shielded 4 wire+drain cable	S: TE snap-on cover, 4-pin male, black	
I: TE snap-on, female straight, unshielded 4 wire cable	X: TE snap-on cover radial, 4-pin male, black	
Cable length		
Example: VFS/---1-20I/5/Q/S-----/EG4/CB/03P/SW-1		
Cable length in meter (Length below 1.00 meter is denoted without a "0" before the dot. Example: .105)		

**Cable connector opposite sensor**

Example: VFS/---1-20I/5/Q/S-----/EG4/CB/03P/SW-1

-B: FCI 90312-004LF/77138-101	-Y: 4 × TE wire pin 966 066-5
-E: Molex 51004-0400/50011-8000	AJ: TE Micro Mate-N-Lok 794617-4/3 × 794607-1/1 × 794606-1/Schlemmer 5308948 (tin plated terminals)
-G: TE Val-U-Lok 794954-4/794958-2, gold plated	AX: Open ended with striped jacket
-X: Open ended	--: No cable included

**Sealing material and class**

Example: VFS/---1-20I/5/Q/S-----/EG4/CB/03P/SW-1

1 <sup>st</sup> character:	A: EPDM o-rings and EPDM sealing cap or sealing sleeve	K: FFKM (high temperature)
	E: EPDM o-rings (drinking water approved)	S: EPDM sealing cap or sealing sleeve and FKM o-rings
	I: EPDM anti-sedimentation seling cap and EPDM o-rings	V: FKM (for use in oily media)
2 <sup>nd</sup> character:	D: Double gelled	-: Not gel filled
	G: Gel filled inside	
3 <sup>rd</sup> character:	2: IP20	6: IP67
	4: IP44	8: IP68
	5: IP55	9: IP54

**Material**

Example: VFS/---1-20I/5/Q/S-----/EG4/CB/03P/SW-1

The first letter represents the flow pipe or housing for DPS, the second represents the mechanical connection part.

B: Brass (leaded)	S: Stainless steel
C: Composite (PPA)	T: Titanium;
G: Cast iron	-: No accessories included

Q:Stainless steel flow pipe w. composite insert (QT) (Stainless steel flow pipe not included in spares sets and some misc. sets)

**Dimension of mechanical connection**

Example: VFS/---1-20I/5/Q/S-----/EG4/CB/03P/SW-1

01: 10 mm	18: 18 mm	37: ISO/DIN PN16 DN100
02: ¼"	24: 1/8"	39: ANSI B16.5 Class 150 - 3"
03: ½"	25: 38 mm	40: ANSI B16.5 Class 150 - 4"
04: ¾"	30: DIN PN25/40 DN18/25/32, ANSI B16.5 Class 300 - 1 1/4"	41: ANSI B16.5 Class 150 - 2.5"
05: 1"	31: DIN PN16/25/40 DN40, ANSI B16.5 Class 300 - 2"	42: ISO/DIN PN25/40 DN100
06: 6 mm	32: DIN PN16/25/40 DN50, ANSI B16.5 Class 300 - 2"	51: f1" - G 3/4; 63: G 1/2 with ventilation opening
07: 1¼"	33: ISO/DIN PN25/40 DN65	66: 1/2" and M8 ventilation port
09: 1½"	34: ANSI B16.5 Class 300 - 2.5"	--: No accessories included
15: 15 mm	35: ISO/DIN PN25/40 DN80	

**Mechanical connection type**

Example: VFS/---1-20I/5/Q/S-----/EG4/CB/03P/SW-1

A: BSPT (ISO 7/1) (thread shorter than standard)	G: Flange and BSPP (ISO 228/1)	S: Sweat
B: BSPT (ISO 7/1)	K: Clip	T: Tube
C: Compression	L: Special clip	V: Bracket
E: Quick fastener	N: NPT	-: No accessories included
F: Flange	P: BSPP (ISO 228/1)	

**Packaging**Example: VFS/---1-20/5/Q/S-----/EG4/CB/03P/**SW-1**

1 <sup>st</sup> character:	A: Set with preassembled components	T: Set variant 2
	M: Miscellaneous	V: Service set
	P: Spares set	-: Not a set
	S: Set	
2 <sup>nd</sup> character:	C: Cardboard box	P: Pallet
	D: Blister pack and cardboard box, std. Grundfos	W: Blister pack, std. Grundfos
	N: Blister pack, neutral white	
3 <sup>rd</sup> character:	-1: 1 piece	25: Bulk 25
	-6: Bulk 6	50: Bulk 50
	10: Bulk 10	1H: Bulk 100
	12: Bulk 12	5H: Bulk 500
	20: Bulk 20	

## 3. Vortex Flow sensor, Industry (VFI and VFI+T2)

### General data



TM047362

VFI sensor

### Technical overview

The VFI flow transmitter from Grundfos Direct Sensors™ is designed for industrial applications. The transmitter is based on the principle of vortex shedding behind a bluff body.

The VFI transmitter is fully compatible with wet, aggressive media. The transmitter is based on MEMS sensing technology in combination with the corrosion-resistant Silicoat® coating technology on the transmitter chip.

This makes the VFI transmitters very robust and ideal for pump integration and monitoring in harsh environments. The transmitter is supplied with a stainless steel flow pipe, available with flanges or in a threaded version.

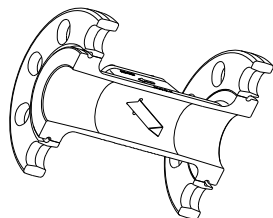

TM049228

Bluff body in a VFI transmitter

### Applications

- Pump control
- HVAC systems
- temperature control and chiller systems
- renewable energies such as heat pumps, solar thermals, fresh water and micro-CHP systems
- monitoring and control systems
- water treatment plants
- water utility and distribution systems
- HPC (High-Performance Computing) and IT cooling systems.

### Features and benefits

- Measurement principle with no movable parts, resulting in no wear and tear
- MEMS technology
- direct contact with the aqueous media resulting in a fast response time
- plug and play for quick setup
- smart system solution with Grundfos pump controls
- compact and robust design
- compatible with aqueous media with a conductivity of 2  $\mu\text{S}/\text{cm}$  or above<sup>1)</sup>
- suitable for a wide temperature range
- suitable for a wide range of application.

<sup>1)</sup> For aqueous media below 2  $\mu\text{S}/\text{cm}$  contact your local Grundfos sensor representative.

### Flow range

$\text{m}^3/\text{h}$	gpm
0.3 - 6	1.32 - 26.42
0.6 - 12	2.64 - 52.83
1.3 - 25	5.72 - 110.07
2 - 40	8.81 - 176.11
3.2 - 64	14.09 - 281.78
5.2 - 104	22.89 - 457.89
8 - 160	35.22 - 704.46
12 - 240	52.83 - 1056.69

### Approvals (w/EPDM O-rings)

- WRAS
- AS 4020
- ACS.

### Compliance

- The versions with EPDM O-rings are compliant with the requirements of the evaluation criteria according to German drinking water regulations (UBA).

### Certificates



C, CSA, US

TM062909

## Markings



TM021695

CE

## Electrical connections

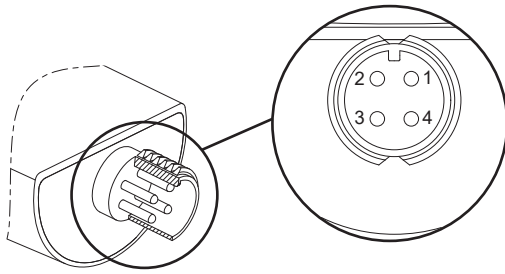

TM061070

### Electrical connections

#### VFI Signal condition: 2-wire, loop-powered.

Pin	1	2	3	4
Wire colour	Brown	White	Blue	Black
I/O	Power supply	Not used	Flow signal 4-20 mA	Not used

Power supply: 12.5 - 30 V, screened cable.

#### VFI+T Signal condition: 4-wire

Pin	1	2	3	4
Wire colour	Brown	White	Blue	Black
I/O	Power supply	Flow signal 0-10 V	GND <sup>2)</sup>	Temperature signal 0-10 V

<sup>2)</sup> Common ground for flow and temperature signals

Power supply, screened cable: SELV or PELV.

## Directives

Grundfos Direct Sensors™ are in conformity with all applicable EU product legislation:

- EMC Directive (2014/30/EU)
  - Standards used: EN 61326-1:2013 and EN 61326-2-3:2013.
- RoHS Directive (2011/65/EU) and (2015/863/EU)
  - Standard used: EN IEC 63000:2018.

Grundfos Direct Sensors™ are not in the scope of:

- Pressure Equipment Directive (2014/68/EU) according to article 4, paragraph 3.
- Low Voltage Directive (2014/35/EU) because the supply voltage is below 75 VDC.

## VFI and VFI+T2, 0.3 - 6 m<sup>3</sup>/h (1.3 - 26.4 gpm)

VFI sensor with flanges and thread

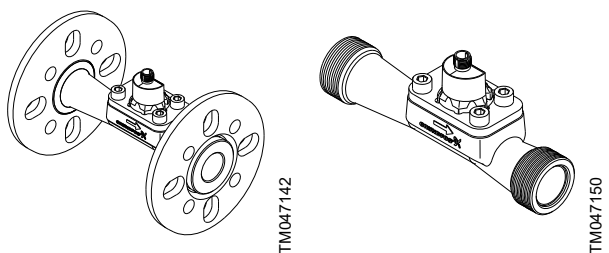

### Dimensions

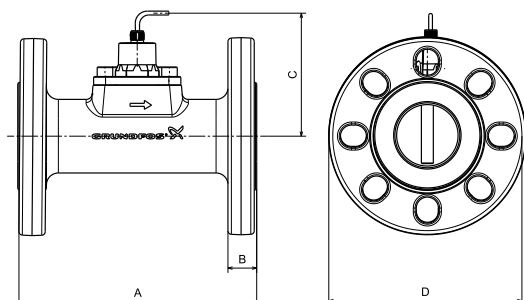

Dimensions, VFI with flanges

	A	B	C	D	ISO/DIN flange, DN 18 pipe	
mm	200	18	120	140	DN 25/32	PN 25/40
in	7.87	0.71	4.72	5.51		

For flanges according to ANSI and JIS standards or for other pressure ranges, contact Grundfos Direct Sensors™.

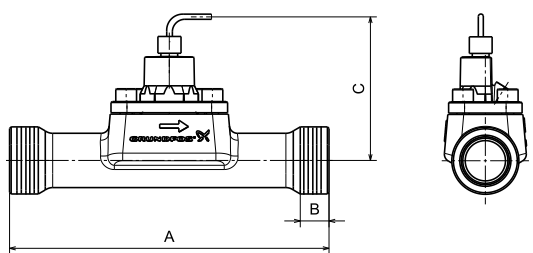

Dimensions, VFI with thread

	A	B	C	Thread size
mm	200	18	120	G1 1/4"
in	7.87	0.71	4.72	

### Sensor output signals

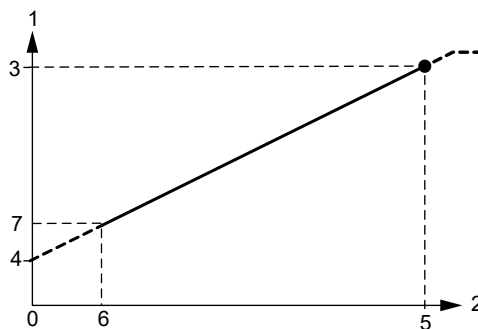

Flow response, VFI

Pos.	Description
0	0 m <sup>3</sup> /h
1	Flow output signal
2	Flow
3	20 mA
4	4 mA
5	Q <sub>max</sub>
6	Q <sub>min</sub>
7	4.8 mA

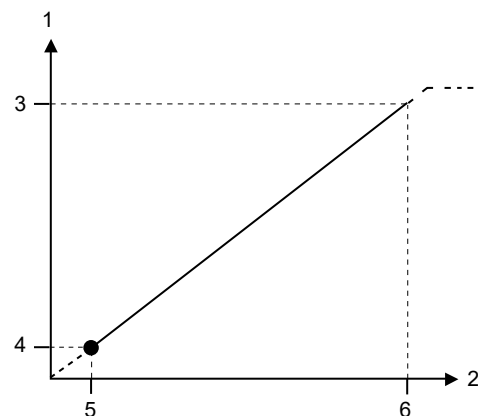

Flow response, VFI+T

Pos.	Description
1	Flow output signal
2	Flow
3	10 V
4	0.5 V
5	Q <sub>min</sub>
6	Q <sub>max</sub>

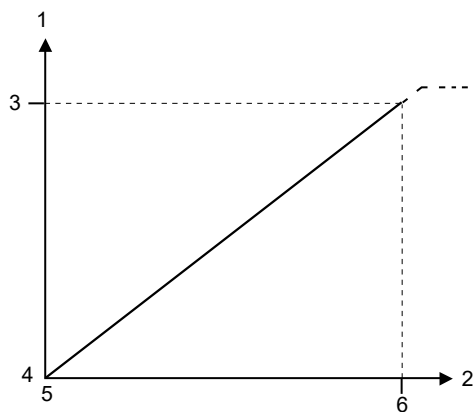

TM082827

Temperature response, VFI+T

Pos.	Description
1	Temperature output signal
2	Temperature
3	10 V
4	0 V
5	T <sub>min</sub>
6	T <sub>max</sub>

Specifications

Flow	
Measuring range (Q <sub>min</sub> to Q <sub>max</sub> )	0.3 - 6 m <sup>3</sup> /h (1.32 to 26.42 gpm)
Accuracy (± 1 σ) in water, 0-100 °C (32-212 °F)	± 1.5 % FS
Response time (63.2 %)	< 1 s
Resolution	0.0075 m <sup>3</sup> /h (0.03 gpm)
Temperature, VFI+T with temperature output	
Measuring range (T <sub>min</sub> to T <sub>max</sub> )	-10 to +120 °C (14-248 °F)
Accuracy (± 1 σ), 15-90 °C (59-194 °F)	± 0.5 K
Accuracy (± 1 σ), -10 to +120 °C (14-248 °F)	± 1 K
Response time (63.2 % at 50 % FS flow)	250 ms
Resolution	0.1 K
System conditions and environment	
Liquid types	Aqueous media compatible with wetted materials. Kinematic viscosity ≤ 6 mm <sup>2</sup> /s (cSt). See Appendix at the end of this document.
Maximum system pressure	30 bar (435 psig)
Burst pressure	40 bar (580 psig)
Liquid temperature, operation	-30 to +110 °C (-22 to +230 °F), non-freezing
Liquid temperature, peak	-30 to +110 °C (-22 to +230 °F), non-freezing
Ambient temperature, operation	-25 to +60 °C (-13 to +140 °F)
Ambient temperature, peak	-55 to +70 °C (-67 to +158 °F)
Storage temperature	-55 to +70 °C (-67 to +158 °F)
Humidity, relative	0-95 %, non-condensing
Pollution degree	3
Altitude	Max. 2000 m.a.s.l.

Location	If installed outdoors, we recommend that it is done in a protective shed or enclosure to avoid direct sunlight and rain.
Electrical data, VFI without temperature output	
Power supply, VFI	12.5 - 30 VDC
Output signal	4-20 mA (4 mA at 0 m <sup>3</sup> /h, 4.8 mA at 0.3 m <sup>3</sup> /h and 20 mA at 6 m <sup>3</sup> /h)
Signal cut off	21 mA
Maximum power consumption	660 mW
Maximum load impedance	60 Ω at 12.5 VDC 100 Ω at 13.3 VDC 600 Ω at 24 VDC 900 Ω at 30 VDC
Maximum cable length	30 m (98 ft)
Electrical data, VFI+T with temperature output	
Power supply	16.6 - 30 VDC
Output signals	0-10 VDC (0 V at 0 m <sup>3</sup> /h, 0.5 V at 0.3 m <sup>3</sup> /h and 10 V at 6 m <sup>3</sup> /h) (0 V at -10 °C, 10 V at 120 °C)
Signal cut off	11 VDC
Maximum power consumption	270 mW
Maximum load impedance	10 kΩ
Maximum cable length	30 m (98 ft)
Materials	
Sensing element	Silicon-based MEMS
O-ring	EPDM or FKM
Housing	Stainless steel 1.4404 (AISI 316 L)
Flow pipe	Stainless steel 1.4408 (AISI 316)
Flange, no liquid contact	Cast iron or stainless steel
Bluff body	Stainless steel 1.4401 (AISI 316 L)
Wetted materials	Corrosion-resistant coating, EPDM or FKM, Stainless steel 1.4401/04 /08 (AISI 316 L)
Environmental standards	
Enclosure class	IP67, cable connected
Temperature cycling	IEC 68-2-14
Vibration, non-destructive	20-2000 Hz, 10 G, 4 h
Electromagnetic compatibility	EN 61326-1
Complete weight	
with cast iron flanges, cable etc.	6.4 kg (14.1 lbs)
with stainless steel flanges, cable etc.	5.2 kg (12.1 lbs)
with thread, unions, fittings, cable etc.	3.4 kg (7.5 lbs)

Install the VFI sensor with threaded ends by means of union nuts with threaded ends by means of union nuts.

### VFI and VFI+T2, 0.6 - 12 m<sup>3</sup>/h (2.6 - 52.8 gpm)

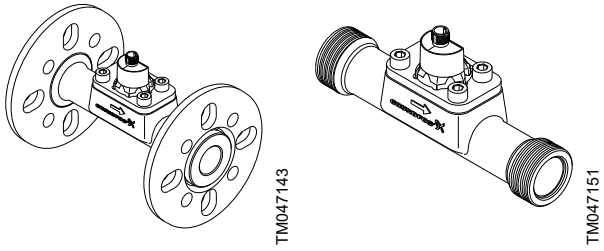

#### Dimensions

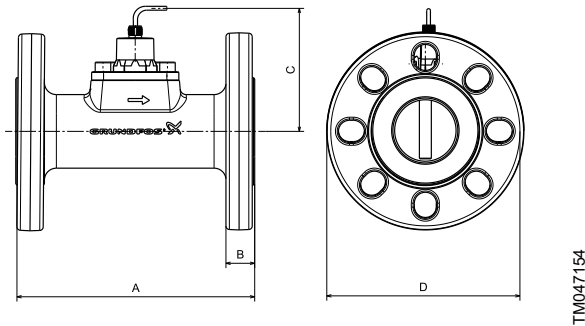

#### Dimensions, VFI with flanges

	A	B	C	D	ISO/DIN flange, DN 25 pipe	
mm	200	18	124	140	DN 25/32	PN 16/25/40
in	7.87	0.71	4.88	5.51		

For flanges according to ANSI and JIS standards or for other pressure ranges, contact Grundfos Direct Sensors™.

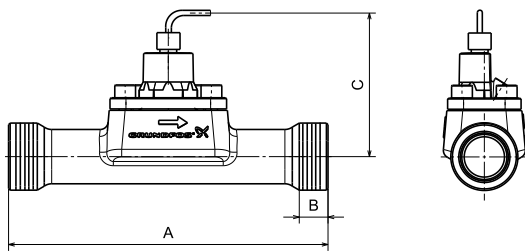

#### Dimensions, VFI with thread

	A	B	C	Thread size
mm	200	18	124	G1 1/4"
in	7.87	0.71	4.88	

#### Sensor output signals

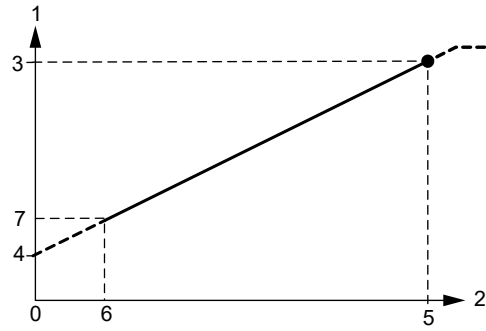

#### Flow response, VFI

Pos.	Description
0	0 m <sup>3</sup> /h
1	Flow output signal
2	Flow
3	20 mA
4	4 mA
5	Q <sub>max</sub>
6	Q <sub>min</sub>
7	4.8 mA

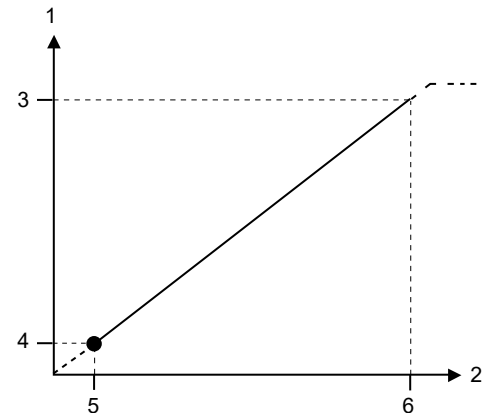

#### Flow response, VFI+T

Pos.	Description
1	Flow output signal
2	Flow
3	10 V
4	0.5 V
5	Q <sub>min</sub>
6	Q <sub>max</sub>

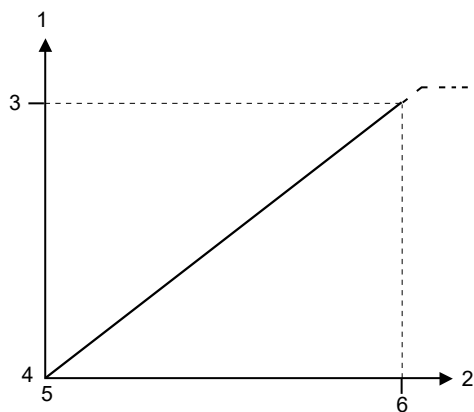

Temperature response, VFI+T

Pos.	Description
1	Temperature output signal
2	Temperature
3	10 V
4	0 V
5	$T_{min}$
6	$T_{max}$

## Specifications

Flow	
Measuring range ( $Q_{min}$ to $Q_{max}$ )	0.6 - 12 m <sup>3</sup> /h (2.64 to 52.83 gpm)
Accuracy ( $\pm 1 \sigma$ ) in water, 0-100 °C (32-212 °F)	$\pm 1.5$ % FS
Response time (63.2 %)	< 1 s
Resolution	0.015 m <sup>3</sup> /h (0.07 gpm)
Temperature, VFI+T with temperature output	
Measuring range ( $T_{min}$ to $T_{max}$ )	-10 to +120 °C (14-248 °F)
Accuracy ( $\pm 1 \sigma$ ), 15-90 °C (59-194 °F)	$\pm 0.5$ K
Accuracy ( $\pm 1 \sigma$ ), -10 to +120 °C (14-248 °F)	$\pm 1$ K
Response time (63.2 % at 50 % FS flow)	250 ms
Resolution	0.1 K
System conditions and environment	
Liquid types	Aqueous media compatible with wetted materials. Kinematic viscosity $\leq 6$ mm <sup>2</sup> /s (cSt). See Appendix at the end of this document.
Max. system pressure	30 bar (435 psig)
Burst pressure	40 bar (580 psig)
Liquid temperature, operation	-30 to +110 °C (-22 to +230 °F), non-freezing
Liquid temperature, peak	-30 to +110 °C (-22 to +230 °F), non-freezing
Ambient temperature, operation	-25 to +60 °C (-13 to +140 °F)
Ambient temperature, peak	-55 to +70 °C (-67 to +158 °F)
Storage temperature	-55 to +70 °C (-67 to +158 °F)
Humidity, relative	0-95 %, non-condensing
Pollution degree	3
Altitude	Max. 2000 m.a.s.l.

Location	If installed outdoors, we recommend that it is done in a protective shed or enclosure to avoid direct sunlight and rain.
Electrical data, VFI without temperature output	
Power supply	12.5 - 30 VDC ( $\pm 5$ %)
Output signals	4-20 mA (4 mA at 0 m <sup>3</sup> /h, 4.8 mA at 0.6 m <sup>3</sup> /h and 20 mA at 12 m <sup>3</sup> /h)
Signal cut off	21 mA
Maximum power consumption	660 mW
Maximum load impedance	60 $\Omega$ at 12.5 VDC 100 $\Omega$ at 13.3 VDC 600 $\Omega$ at 24 VDC 900 $\Omega$ at 30 VDC
Maximum cable length	30 m (98 ft)
Electrical data, VFI+T with temperature output	
Power supply, VFI	16.6 - 30 VDC
Output signals	0-10 VDC (0 V at 0 m <sup>3</sup> /h, 0.5 V at 0.6 m <sup>3</sup> /h and 10 V at 12 m <sup>3</sup> /h) (0 V at -10 °C, 10 V at 120 °C)
Signal cut off	11 VDC
Maximum power consumption	270 mW
Maximum load impedance	10 k $\Omega$
Maximum cable length	30 m (98 ft)
Materials	
Sensing element	Silicon-based MEMS
O-ring	EPDM or FKM
Housing	Stainless steel 1.4404 (AISI 316 L)
Flow pipe	Stainless steel 1.4408 (AISI 316)
Flange, no liquid contact	Cast iron or stainless steel
Bluff body	Stainless steel 1.4401 (AISI 316 L)
Wetted materials	Corrosion-resistant coating, EPDM or FKM, Stainless steel 1.4401/04 /08 (AISI 316 L)
Environmental standards	
Enclosure class	IP67, cable connected
Temperature cycling	IEC 68-2-14
Vibration, non-destructive	20-2000 Hz, 10 G, 4 h
Electromagnetic compatibility	EN 61326-1
Complete weight	
with cast iron flanges, cable etc.	6.5 kg (14.3 lbs)
with stainless steel flanges, cable etc.	5.6 kg (12.3 lbs)
with thread, unions, fittings, cable etc.	3.6 kg (7.9 lbs)

Install the VFI sensor with threaded ends by means of union nuts.

### VFI and VFI+T2, 1.3 - 25 m<sup>3</sup>/h (5.7 - 110 gpm)

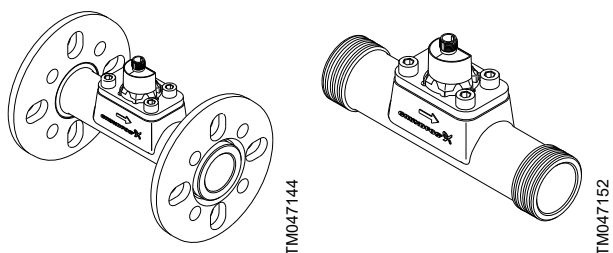

#### Dimensions

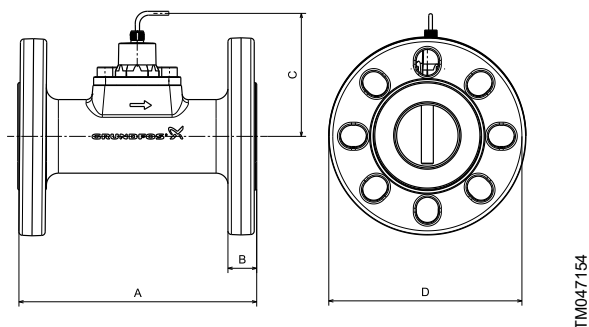

#### Dimensions, VFI with flanges

	A	B	C	D	ISO/DIN flange, DN 32 pipe	
mm	200	18	128	140	DN 25/32	PN 16/25/40
in	7.87	0.71	5.04	5.51		

For flanges according to ANSI and JIS standards or for other pressure ranges, contact Grundfos Direct Sensors™.

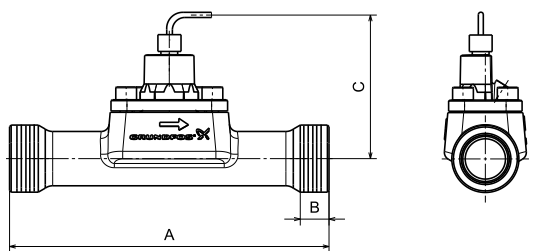

#### Dimensions, VFI with thread

	A	B	C	Thread size
mm	200	19	128	G1 1/2"
in	7.87	0.75	5.04	

#### Sensor output signals

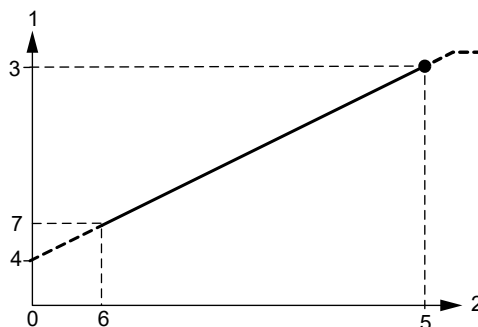

#### Flow response, VFI

Pos.	Description
0	0 m <sup>3</sup> /h
1	Flow output signal
2	Flow
3	20 mA
4	4 mA
5	Q <sub>max</sub>
6	Q <sub>min</sub>
7	4.8 mA

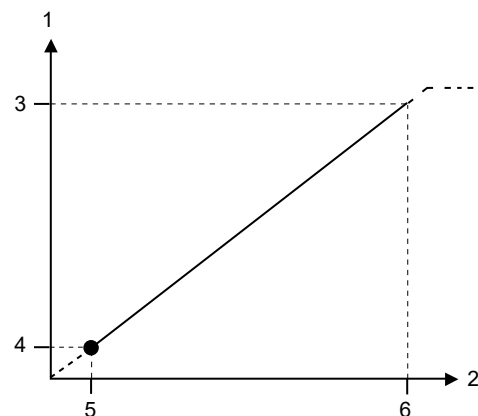

#### Flow response, VFI+T

Pos.	Description
1	Flow output signal
2	Flow
3	10 V
4	0.5 V
5	Q <sub>min</sub>
6	Q <sub>max</sub>

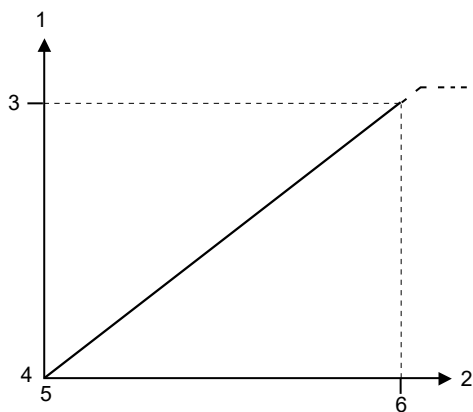

Temperature response, VFI+T

Pos.	Description
1	Temperature output signal
2	Temperature
3	10 V
4	0 V
5	$T_{min}$
6	$T_{max}$

## Specifications

Flow	
Measuring range ( $Q_{min}$ to $Q_{max}$ )	1.3 - 25 m <sup>3</sup> /h (5.72 to 110.07 gpm)
Accuracy ( $\pm 1 \sigma$ ) in water, 0-100 °C (32-212 °F)	$\pm 1.5$ % FS
Response time	< 1 s
Resolution	0.031 m <sup>3</sup> /h (0.14 gpm)
Temperature, VFI+T with temperature output	
Measuring range ( $T_{min}$ to $T_{max}$ )	-10 to +120 °C (14-248 °F)
Accuracy ( $\pm 1 \sigma$ ), 15-90 °C (59-194 °F)	$\pm 0.5$ K
Accuracy ( $\pm 1 \sigma$ ), -10 to +120 °C (14-248 °F)	$\pm 1$ K
Response time (63.2 % at 50 % FS flow)	250 ms
Resolution	0.1 K
System conditions and environment	
Liquid types	Aqueous media compatible with wetted materials. Kinematic viscosity $\leq 6$ mm <sup>2</sup> /s (cSt). See Appendix at the end of this document.
Max. system pressure	30 bar (435 psig)
Burst pressure	40 bar (580 psig)
Liquid temperature, operation	-30 to +110 °C (-22 to +230 °F), non-freezing
Liquid temperature, peak	-30 to +110 °C (-22 to +230 °F), non-freezing
Ambient temperature, operation	-25 to +60 °C (-13 to +140 °F)
Ambient temperature, peak	-55 to +70 °C (-67 to +158 °F)
Storage temperature	-55 to +70 °C (-67 to +158 °F)
Humidity, relative	0-95 %, non-condensing
Pollution degree	3
Altitude	Max. 2000 m.a.s.l.

Location	If installed outdoors, we recommend that it is done in a protective shed or enclosure to avoid direct sunlight and rain.
Electrical data, VFI without temperature output	
Power supply, VFI	12.5 - 30 VDC
Output signals	4-20 mA (4 mA at 0 m <sup>3</sup> /h, 4.8 mA at 1.3 m <sup>3</sup> /h and 20 mA at 25 m <sup>3</sup> /h)
Signal cut off	21 mA
Maximum power consumption	660 mW
Maximum load impedance	60 $\Omega$ at 12.5 VDC 100 $\Omega$ at 13.3 VDC 600 $\Omega$ at 24 VDC 900 $\Omega$ at 30 VDC
Maximum cable length	30 m (98 ft)
Electrical data, VFI+T with temperature output	
Power supply, VFI	16.6 - 30 VDC
Output signals	0-10 VDC (0 V at 0 m <sup>3</sup> /h, 0.5 V at 1.3 m <sup>3</sup> /h and 10 V at 25 m <sup>3</sup> /h) (0 V at -10 °C, 10 V at 120 °C)
Signal cut off	11 VDC
Maximum power consumption	270 mW
Maximum load impedance	10 k $\Omega$
Maximum cable length	30 m (98 ft)
Materials	
Sensing element	Silicon-based MEMS
O-ring	EPDM or FKM
housing	Stainless steel 1.4404 (AISI 316 L)
Flow pipe	Stainless steel 1.4408 (AISI 316)
Flange, no liquid contact	Cast iron or stainless steel
Bluff body	Stainless steel 1.4401 (AISI 316 L)
Wetted materials	Corrosion-resistant coating, EPDM or FKM, Stainless steel 1.4401/04 /08 (AISI 316 L)
Environmental standards	
Enclosure class	IP67, cable connected
Temperature cycling	IEC 68-2-14
Vibration, non-destructive	20-2000 Hz, 10 G, 4 h
Electromagnetic compatibility	EN 61326-1
Complete weight	
with cast iron flanges, cable etc.	6.5 kg (14.3 lbs)
with stainless steel flanges, cable etc.	5.6 kg (12.3 lbs)
with thread, unions, fittings, cable etc.	3.9 kg (8.6 lbs)

Install the VFI sensor with threaded ends by means of union nuts.

# VFI and VFI+T2, 2-40 m<sup>3</sup>/h (8.8 - 176 gpm)

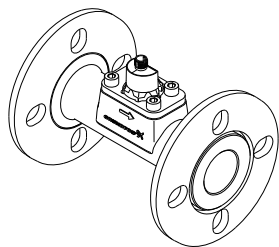

VFI 2-40 sensor

## Dimensions

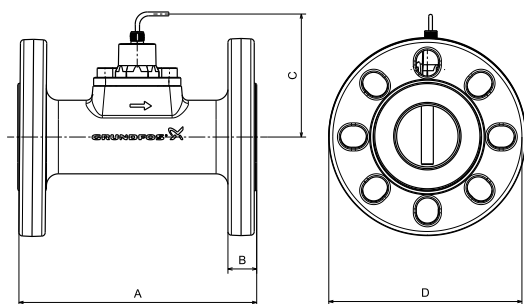

Dimensions, VFI with flanges

	A	B	C	D	ISO/DIN flange	
mm	200	18	131	150	DN 40	PN 16/25/40
in	7.87	0.71	5.16	5.91		

For flanges according to ANSI and JIS standards or for other pressure ranges, contact Grundfos Direct Sensors™.

## Sensor output signals

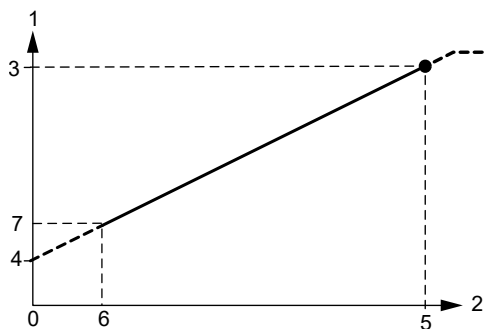

Flow response, VFI

Pos.	Description
0	0 m <sup>3</sup> /h
1	Flow output signal
2	Flow
3	20 mA
4	4 mA

Pos.	Description
5	Q <sub>max</sub>
6	Q <sub>min</sub>
7	4.8 mA

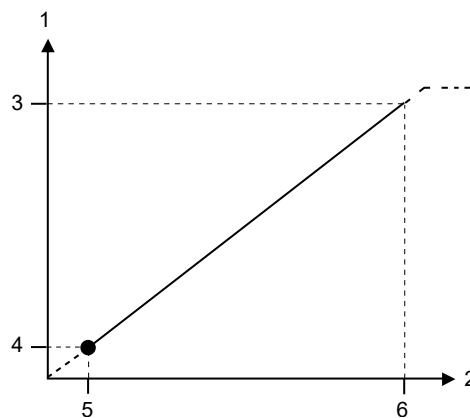

Flow response, VFI+T

Pos.	Description
1	Flow output signal
2	Flow
3	10 V
4	0.5 V
5	Q <sub>min</sub>
6	Q <sub>max</sub>

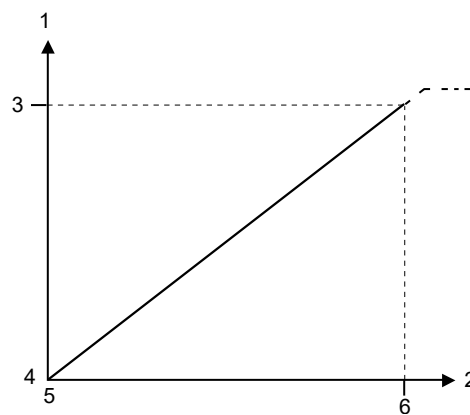

Temperature response, VFI+T

Pos.	Description
1	Temperature output signal
2	Temperature
3	10 V
4	0 V
5	T <sub>min</sub>
6	T <sub>max</sub>

TM047145

TM082826

TM047154

TM082827

TM082825

## Specifications

<b>Flow</b>	
Measuring range ( $Q_{\min}$ to $Q_{\max}$ )	2-40 m <sup>3</sup> /h (8.81 to 176.11 gpm)
Accuracy ( $\pm 1 \sigma$ ) in water, 0-100 °C (32-212 °F)	$\pm 1.5\%$ FS
Response time	< 1 s
Resolution	0.05 m <sup>3</sup> /h (0.22 gpm)
<b>Temperature, VFI+T with temperature output</b>	
Measuring range ( $T_{\min}$ to $T_{\max}$ )	-10 to +120 °C (14-248 °F)
Accuracy ( $\pm 1 \sigma$ ), 15-90 °C (59-194 °F)	$\pm 0.5$ K
Accuracy ( $\pm 1 \sigma$ ), -10 to +120 °C (14-248 °F)	$\pm 1$ K
Response time (63.2 % at 50 % FS flow)	250 ms
Resolution	0.1 K
<b>System conditions and environment</b>	
Liquid types	Aqueous media compatible with wetted materials. Kinematic viscosity $\leq 6$ mm <sup>2</sup> /s (cSt). See Appendix at the end of this document.
Maximum system pressure	30 bar (435 psig)
Burst pressure	40 bar (580 psig)
Liquid temperature, operation	-30 to +110 °C (-22 to +230 °F), non-freezing
Liquid temperature, peak	-30 to +110 °C (-22 to +230 °F), non-freezing
Ambient temperature, operation	-25 to +60 °C (-13 to +140 °F)
Ambient temperature, peak	-55 to +70 °C (-67 to +158 °F)
Storage temperature	-55 to +70 °C (-67 to +158 °F)
Humidity, relative	0-95 %, non-condensing
Pollution degree	3
Altitude	Max. 2000 m.a.s.l.
Location	If installed outdoors, we recommend that it is done in a protective shed or enclosure to avoid direct sunlight and rain.
<b>Electrical data, VFI without temperature output</b>	
Power supply	12.5 - 30 VDC ( $\pm 5\%$ )
Output signals	4-20 mA (4 mA at 0 m <sup>3</sup> /h, 4.8 mA at 2 m <sup>3</sup> /h and 20 mA at 40 m <sup>3</sup> /h)
Signal cut off	21 mA
Maximum power consumption	660 mW
Maximum load impedance	60 $\Omega$ at 12.5 VDC 100 $\Omega$ at 13.3 VDC 600 $\Omega$ at 24 VDC 900 $\Omega$ at 30 VDC
Maximum cable length	30 m (98 ft)
<b>Electrical data, VFI+T with temperature output</b>	
Power supply, VFI	16.6 - 30 VDC
Output signals	0-10 VDC (0 V at 0 m <sup>3</sup> /h, 0.5 V at 2 m <sup>3</sup> /h and 10 V at 40 m <sup>3</sup> /h) (0 V at -10 °C, 10 V at 120 °C)
Signal cut off	11 VDC
Maximum power consumption	270 mW
Maximum load impedance	10 k $\Omega$
Maximum cable length	30 m (98 ft)

<b>Materials</b>	
Sensing element	Silicon-based MEMS
O-ring	EPDM or FKM
Housing	Stainless steel 1.4404 (AISI 316 L)
Flow pipe	Stainless steel 1.4408 (AISI 316)
Flange, no liquid contact	Cast iron or stainless steel
Bluff body	Stainless steel 1.4401 (AISI 316 L)
Wetted materials	Corrosion-resistant coating, EPDM or FKM, Stainless steel 1.4401/04 /08 (AISI 316 L)
<b>Environmental standards</b>	
Enclosure class	IP67, cable connected
Temperature cycling	IEC 68-2-14
Vibration, non-destructive	20-2000 Hz, 10 G, 4 h
Electromagnetic compatibility	EN 61326-1
<b>Complete weight</b>	
With cast iron flanges, cable etc.	7.4 kg (16.3 lbs)
With stainless steel flanges, cable etc.	6.5 kg (14.3 lbs)

## VFI and VFI+T2, 3.2 - 64 m<sup>3</sup>/h (14-282 gpm)

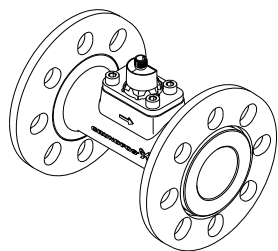

VFI sensor

### Dimensions

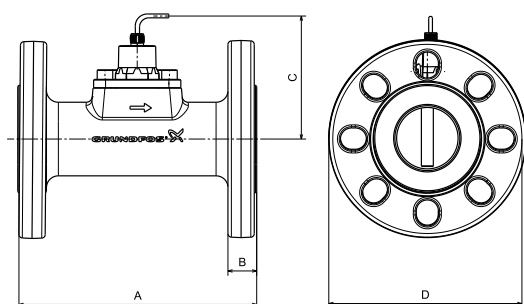

Dimensions, VFI with flanges

	A	B	C	D	ISO/DIN flange	
mm	200	22	138	165	DN 50	PN16/25/40
in	7.87	0.87	5.43	6.50		

For flanges according to ANSI and JIS standards or for other pressure ranges, contact Grundfos Direct Sensors™.

### Sensor output signals

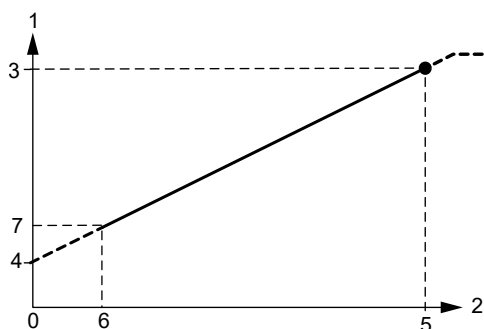

Flow response, VFI

Pos.	Description
0	0 m <sup>3</sup> /h
1	Flow output signal
2	Flow
3	20 mA
4	4 mA

Pos.	Description
5	Q <sub>max</sub>
6	Q <sub>min</sub>
7	4.8 mA

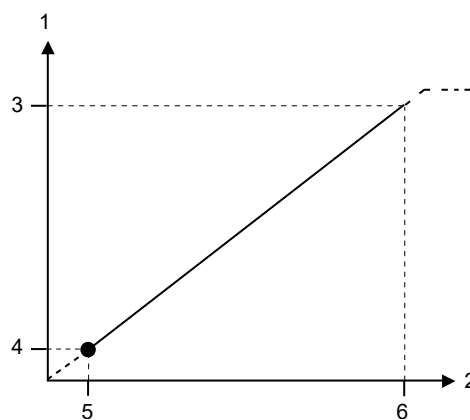

Flow response, VFI+T

Pos.	Description
1	Flow output signal
2	Flow
3	10 V
4	0.5 V
5	Q <sub>min</sub>
6	Q <sub>max</sub>

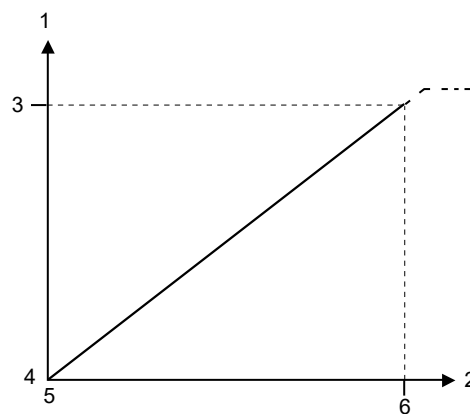

Temperature response, VFI+T

Pos.	Description
1	Temperature output signal
2	Temperature
3	10 V
4	0 V
5	T <sub>min</sub>
6	T <sub>max</sub>

## Specifications

<b>Flow</b>	
Measuring range ( $Q_{\min}$ to $Q_{\max}$ )	3.2 - 64 m <sup>3</sup> /h (14.09 to 281.78 gpm)
Accuracy ( $\pm 1 \sigma$ ) in water, 0-100 °C (32-212 °F)	$\pm 1.5$ % FS
Response time (63.2 %)	< 1 s
Resolution	0.08 m <sup>3</sup> /h (0.35 gpm)
<b>Temperature, VFI+T with temperature output</b>	
Measuring range ( $T_{\min}$ to $T_{\max}$ )	-10 to +120 °C (14-248 °F)
Accuracy ( $\pm 1 \sigma$ ), 15-90 °C (59-194 °F)	$\pm 0.5$ K
Accuracy ( $\pm 1 \sigma$ ), -10 to +120 °C (14-248 °F)	$\pm 1$ K
Response time (63.2 % at 50 % FS flow)	250 ms
Resolution	0.1 K
<b>System conditions and environment</b>	
Liquid types	Aqueous media compatible with wetted materials. Kinematic viscosity $\leq 6$ mm <sup>2</sup> /s (cSt). See Appendix at the end of this document.
Maximum system pressure	30 bar (435 psig)
Burst pressure	40 bar (580 psig)
Liquid temperature, operation	-30 to +110 °C (-22 to +230 °F), non-freezing
Liquid temperature, peak	-30 to +110 °C (-22 to +230 °F), non-freezing
Ambient temperature, operation	-25 to +60 °C (-13 to +140 °F)
Ambient temperature, peak	-55 to +70 °C (-67 to +158 °F)
Storage temperature	-55 to +70 °C (-67 to +158 °F)
Humidity, relative	0-95 %, non-condensing
Pollution degree	3
Altitude	Max. 2000 m.a.s.l.
Location	If installed outdoors, we recommend that it is done in a protective shed or enclosure to avoid direct sunlight and rain.
<b>Electrical data, VFI without temperature output</b>	
Power supply	12.5 - 30 VDC
Output signals	4-20 mA (4 mA at 0 m <sup>3</sup> /h, 4.8 mA at 3.2 m <sup>3</sup> /h and 20 mA at 64 m <sup>3</sup> /h)
Signal cut off	21 mA
Maximum power consumption	660 mW
Maximum load impedance	60 $\Omega$ at 12.5 VDC 100 $\Omega$ at 13.3 VDC 600 $\Omega$ at 24 VDC 900 $\Omega$ at 30 VDC
Maximum cable length	30 m (98 ft)
<b>Electrical data, VFI+T with temperature output</b>	
Power supply	16.6 - 30 VDC
Output signals	0-10 VDC (0 V at 0 m <sup>3</sup> /h, 0.5 V at 3.2 m <sup>3</sup> /h and 10 V at 64 m <sup>3</sup> /h) (0 V at -10 °C, 10 V at 120 °C)
Signal cut off	11 VDC
Maximum power consumption	270 mW
Maximum load impedance	10 k $\Omega$
Maximum cable length	30 m (98 ft)
<b>Materials</b>	
Sensing element	Silicon-based MEMS

O-ring	EPDM or FKM
Housing	Stainless steel 1.4404 (AISI 316 L)
Flow pipe	Stainless steel 1.4408 (AISI 316)
Flange, no liquid contact	Cast iron or stainless steel
Bluff body	Stainless steel 1.4401 (AISI 316 L)
Wetted materials	Corrosion-resistant coating, EPDM or FKM, Stainless steel 1.4401/04 /08 (AISI 316 L)
<b>Environmental standards</b>	
Enclosure class	IP67, cable connected
Temperature cycling	IEC 68-2-14
Vibration, non-destructive	20-2000 Hz, 10 G, 4 h
Electromagnetic compatibility	EN 61326-1
<b>Complete weight</b>	
With cast iron flanges, cable etc.	9.4 kg (20.7 lbs)
With stainless steel flanges, cable etc.	8.2 kg (18.0 lbs)

### VFI and VFI+T2, 5.2 - 104 m<sup>3</sup>/h (23-458 gpm)

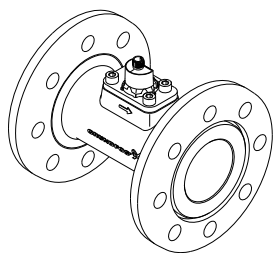

VFI sensor

#### Dimensions

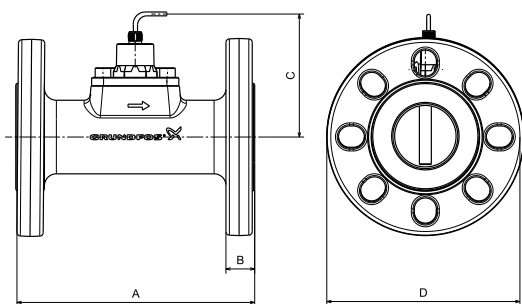

Dimensions, VFI with flanges

	A	B	C	D	ISO/DIN flange	
mm	200	25	145	185	DN 65	PN 16/25/40
in	7.87	0.98	5.71	7.28		

For flanges according to ANSI and JIS standards or for other pressure ranges, contact Grundfos Direct Sensors™.

#### Sensor output signals

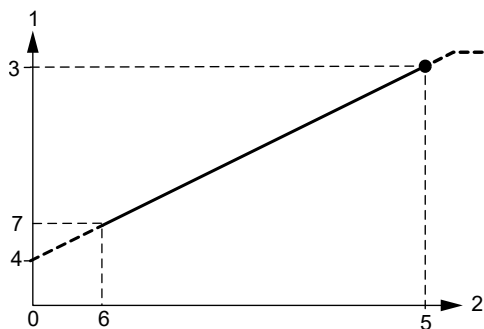

Flow response, VFI

Pos.	Description
0	0 m <sup>3</sup> /h
1	Flow output signal
2	Flow
3	20 mA
4	4 mA

TM047147

TM047154

TM082825

Pos.	Description
5	Q <sub>max</sub>
6	Q <sub>min</sub>
7	4.8 mA

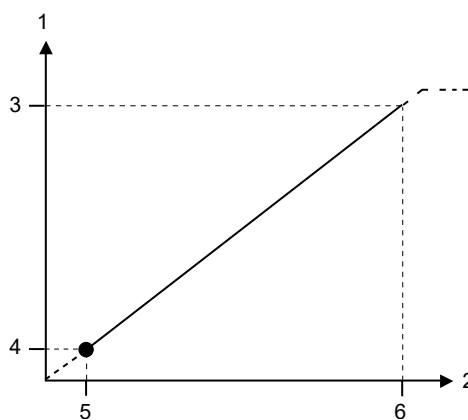

Flow response, VFI+T

Pos.	Description
1	Flow output signal
2	Flow
3	10 V
4	0.5 V
5	Q <sub>min</sub>
6	Q <sub>max</sub>

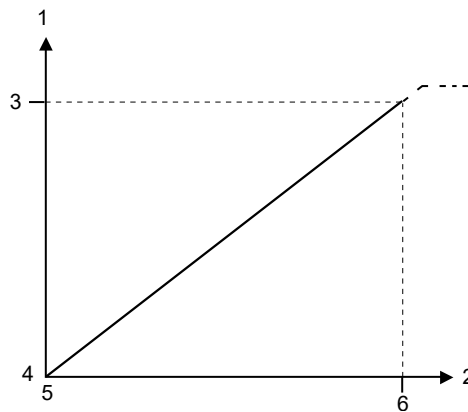

Temperature response, VFI+T

Pos.	Description
1	Temperature output signal
2	Temperature
3	10 V
4	0 V
5	T <sub>min</sub>
6	T <sub>max</sub>

TM082826

TM082827

## Specifications

<b>Flow</b>	
Measuring range ( $Q_{\min}$ to $Q_{\max}$ )	5.2 - 104 m <sup>3</sup> /h (22.89 - 457.89 gpm)
Accuracy ( $\pm 1 \sigma$ ) in water, 0-100 °C (32-212 °F)	$\pm 1.5$ % FS
Response time	< 1 s
Resolution	0.13 m <sup>3</sup> /h (0.57 gpm)
<b>Temperature, VFI+T with temperature output</b>	
Measuring range ( $T_{\min}$ to $T_{\max}$ )	-10 to +120 °C (14-248 °F)
Accuracy ( $\pm 1 \sigma$ ), 15-90 °C (59-194 °F)	$\pm 0.5$ K
Accuracy ( $\pm 1 \sigma$ ), -10 to +120 °C (14-248 °F)	$\pm 1$ K
Response time (63.2 % at 50 % FS flow)	250 ms
Resolution	0.1 K
<b>System conditions and environment</b>	
Liquid types	Aqueous media compatible with wetted materials. Kinematic viscosity $\leq 6$ mm <sup>2</sup> /s (cSt). See Appendix at the end of this document.
Maximum system pressure	30 bar (435 psig)
Burst pressure	40 bar (580 psig)
Liquid temperature, operation	-30 to +110 °C (-22 to +230 °F), non-freezing
Liquid temperature, peak	-30 to +110 °C (-22 to +230 °F), non-freezing
Ambient temperature, operation	-25 to +60 °C (-13 to +140 °F)
Ambient temperature, peak	-55 to +70 °C (-67 to +158 °F)
Storage temperature	-55 to +70 °C (-67 to +158 °F)
Humidity, relative	0-95 %, non-condensing
Pollution degree	3
Altitude	Max. 2000 m.a.s.l.
Location	If installed outdoors, we recommend that it is done in a protective shed or enclosure to avoid direct sunlight and rain.
<b>Electrical data, VFI without temperature output</b>	
Power supply, VFI	12.5 - 30 VDC ( $\pm 5$ %)
Output signals	4-20 mA (4 mA at 0 m <sup>3</sup> /h, 4.8 mA at 5.2 m <sup>3</sup> /h and 20 mA at 104 m <sup>3</sup> /h)
Signal cut off	21 mA
Maximum power consumption	660 mW
Maximum load impedance	60 $\Omega$ at 12.5 VDC
	100 $\Omega$ at 13.3 VDC
	600 $\Omega$ at 24 VDC
	900 $\Omega$ at 30 VDC
Maximum cable length	30 m (98 ft)
<b>Electrical data, VFI+T with temperature output</b>	
Power supply, VFI	16.6 - 30 VDC
Output signals	0-10 VDC (0 V at 0 m <sup>3</sup> /h, 0.5 V at 5.2 m <sup>3</sup> /h and 10 V at 104 m <sup>3</sup> /h) (0 V at -10 °C, 10 V at 120 °C)
Signal cut off	11 VDC
Maximum power consumption	270 mW
Maximum load impedance	10 k $\Omega$
Maximum cable length	30 m (98 ft)
<b>Materials</b>	
Sensing element	Silicon-based MEMS

O-ring	EPDM or FKM
Housing	Stainless steel 1.4404 (AISI 316 L)
Flow pipe	Stainless steel 1.4408 (AISI 316)
Flange, no liquid contact	Cast iron or stainless steel
Bluff body	Stainless steel 1.4401 (AISI 316 L)
Wetted materials	Corrosion-resistant coating, PDM or FKM, stainless steel 1.4401/04 /08 (AISI 316 L)
<b>Environmental standards</b>	
Enclosure class	IP67, cable connected
Temperature cycling	IEC 68-2-14
Vibration, non-destructive	20-2000 Hz, 10 G, 4 h
Electromagnetic compatibility	EN 61326-1
<b>Complete weight</b>	
With cast iron flanges, cable etc.	11.5 kg (25.3 lbs)
With stainless steel flanges, cable etc.	11.9 kg (26.2 lbs)

# VFI and VFI+T2, 8-160 m<sup>3</sup>/h (35-704 gpm)

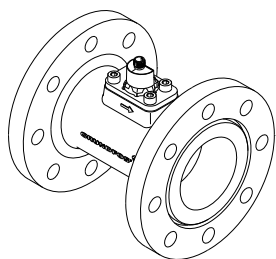

VFI sensor

## Dimensions

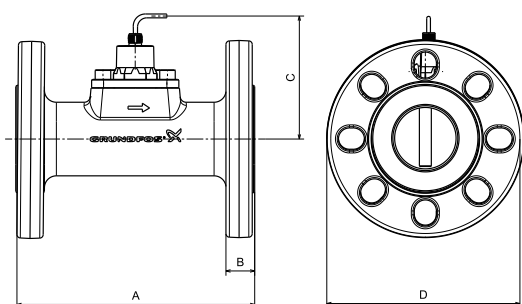

Dimensions, VFI with flanges

	A	B	C	D	ISO/DIN flange	
mm	200	25	152	200	DN 80	PN 16/25/40
in	7.87	0.98	5.98	7.87		

For flanges according to ANSI and JIS standards or for other pressure ranges, contact Grundfos Direct Sensors™.

## Sensor output signals

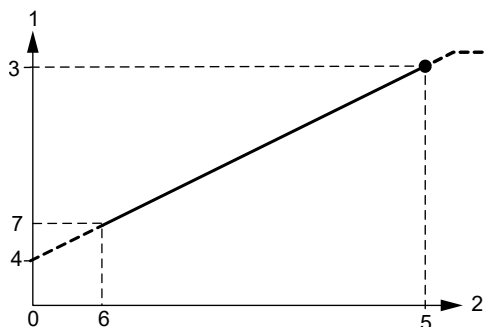

Flow response, VFI

Pos.	Description
0	0 m <sup>3</sup> /h
1	Flow output signal
2	Flow
3	20 mA
4	4 mA

TM047148

TM047154

TM082825

Pos.	Description
5	Q <sub>max</sub>
6	Q <sub>min</sub>
7	4.8 mA

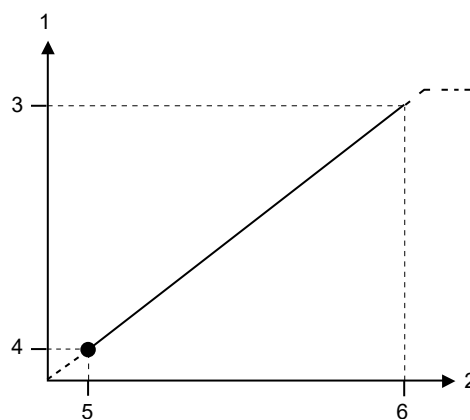

Flow response, VFI+T

Pos.	Description
1	Flow output signal
2	Flow
3	10 V
4	0.5 V
5	Q <sub>min</sub>
6	Q <sub>max</sub>

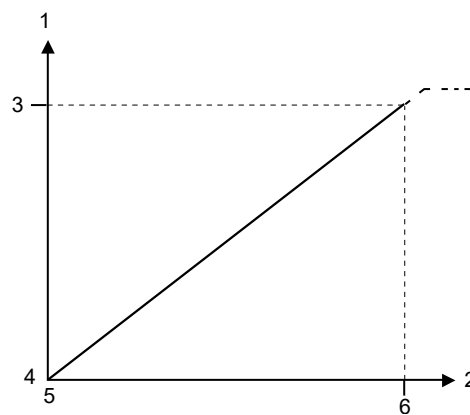

Temperature response, VFI+T

Pos.	Description
1	Temperature output signal
2	Temperature
3	10 V
4	0 V
5	T <sub>min</sub>
6	T <sub>max</sub>

TM082826

TM082827

## Specifications

<b>Flow</b>	
Measuring range ( $Q_{min}$ to $Q_{max}$ )	8-160 m <sup>3</sup> /h (35.22 to 704.46 gpm)
Accuracy ( $\pm 1 \sigma$ ) in water, 0-100 °C (32-212 °F)	$\pm 1.5$ % FS
Response time	< 1 s
Resolution	0.2 m <sup>3</sup> /h (0.88 gpm)
<b>Temperature, VFI+T with temperature output</b>	
Measuring range ( $T_{min}$ to $T_{max}$ )	-10 to +120 °C (14-248 °F)
Accuracy ( $\pm 1 \sigma$ ), 15-90 °C (59-194 °F)	$\pm 0.5$ K
Accuracy ( $\pm 1 \sigma$ ), -10 to +120 °C (14-248 °F)	$\pm 1$ K
Response time (63.2 % at 50 % FS flow)	250 ms
Resolution	0.1 K
<b>System conditions and environment</b>	
Liquid types	Aqueous media compatible with wetted materials. Kinematic viscosity $\leq 6$ mm <sup>2</sup> /s (cSt). See Appendix at the end of this document.
Maximum system pressure	30 bar (435 psig)
Burst pressure	40 bar (580 psig)
Liquid temperature, operation	-30 to +110 °C (-22 to +230 °F), non-freezing
Liquid temperature, peak	-30 to +110 °C (-22 to +230 °F), non-freezing
Ambient temperature, operation	-25 to +60 °C (-13 to +140 °F)
Ambient temperature, peak	-55 to +70 °C (-67 to +158 °F)
Storage temperature	-55 to +70 °C (-67 to +158 °F)
Humidity, relative	0-95 %, non-condensing
Pollution degree	3
Altitude	Max. 2000 m.a.s.l.
Location	If installed outdoors, we recommend that it is done in a protective shed or enclosure to avoid direct sunlight and rain.
<b>Electrical data, VFI without temperature output</b>	
Power supply	12.5 - 30 VDC ( $\pm 5$ %)
Output signals	4-20 mA (4 mA at 0 m <sup>3</sup> /h, 4.8 mA at 8 m <sup>3</sup> /h and 20 mA at 160 m <sup>3</sup> /h)
Signal cut off	21 mA
Maximum power consumption	660 mW
Maximum load impedance	60 $\Omega$ at 12.5 VDC
	100 $\Omega$ at 13.3 VDC
	600 $\Omega$ at 24 VDC
	900 $\Omega$ at 30 VDC
Maximum cable length	30 m (98 ft)
<b>Electrical data, VFI+T with temperature output</b>	
Power supply	16.6 - 30 VDC
Output signals	0-10 VDC (0 V at 0 m <sup>3</sup> /h, 0.5 V at 8 m <sup>3</sup> /h and 10 V at 160 m <sup>3</sup> /h) (0 V at -10 °C, 10 V at 120 °C)
Signal cut off	11 VDC
Maximum power consumption	270 mW
Maximum load impedance	10 k $\Omega$
Maximum cable length	30 m (98 ft)
<b>Materials</b>	
Sensing element	Silicon-based MEMS

O-ring	EPDM or FKM
Housing	Stainless steel 1.4404 (AISI 316 L)
Flow pipe	Stainless steel 1.4408 (AISI 316)
Flange, no liquid contact	Cast iron or stainless steel
Bluff body	Stainless steel 1.4401 (AISI 316 L)
Wetted materials	Corrosion-resistant coating, EPDM or FKM, Stainless steel 1.4401/04 /08 (AISI 316 L)
<b>Environmental standards</b>	
Enclosure class	IP67, cable connected
Temperature cycling	IEC 68-2-14
Vibration, non-destructive	20-2000 Hz, 10 G, 4 h
Electromagnetic compatibility	EN 61326-1
<b>Complete weight</b>	
With cast iron flanges, cable etc.	13.2 kg (29.0 lbs)
With stainless steel flanges, cable etc.	13.7 kg (30.1 lbs)

## VFI and VFI+T2, 12-240 m<sup>3</sup>/h (53-1057 gpm)

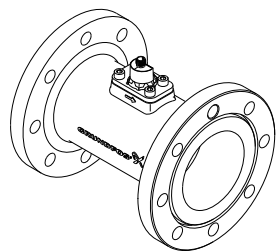

VFI sensor

### Dimensions

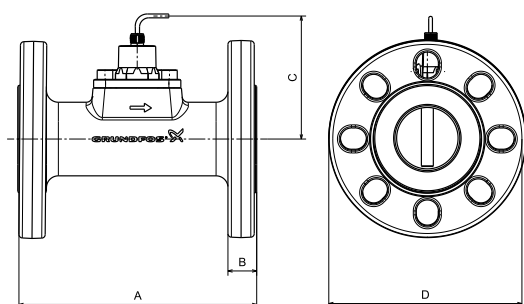

Dimensions, VFI with flanges

	A	B	C	D	ISO/DIN flange	
mm	250	25	163	235	DN 100	PN 25/40
in	9.84	0.98	6.42	9.25		

For flanges according to ANSI and JIS standards or for other pressure ranges, contact Grundfos Direct Sensors™. Flanged with PN 16 available upon request.

### Sensor output signals

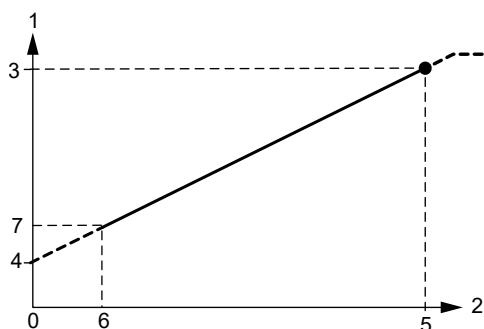

Flow response, VFI

Pos.	Description
0	0 m <sup>3</sup> /h
1	Flow output signal
2	Flow
3	20 mA
4	4 mA

Pos.	Description
5	Q <sub>max</sub>
6	Q <sub>min</sub>
7	4.8 mA

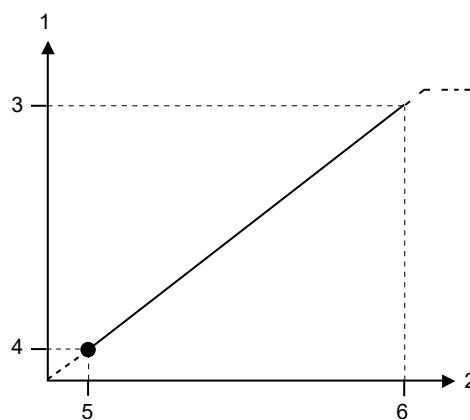

Flow response, VFI+T

Pos.	Description
1	Flow output signal
2	Flow
3	10 V
4	0.5 V
5	Q <sub>min</sub>
6	Q <sub>max</sub>

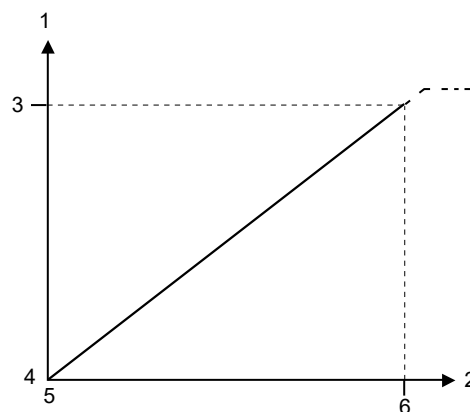

Temperature response, VFI+T

Pos.	Description
1	Temperature output signal
2	Temperature
3	10 V
4	0 V
5	T <sub>min</sub>
6	T <sub>max</sub>

## Specifications

<b>Flow</b>	
Measuring range ( $Q_{min}$ to $Q_{max}$ )	12-240 m <sup>3</sup> /h (52.83 to 1056.69 gpm)
Accuracy ( $\pm 1 \sigma$ ) in water, 0-100 °C (32-212 °F)	$\pm 1.5$ % FS
Response time	< 1 s
Resolution	0.30 m <sup>3</sup> /h (1.32 gpm)
<b>Temperature, VFI+T with temperature output</b>	
Measuring range ( $T_{min}$ to $T_{max}$ )	-10 to +120 °C (14-248 °F)
Accuracy ( $\pm 1 \sigma$ ), 15-90 °C (59-194 °F)	$\pm 0.5$ K
Accuracy ( $\pm 1 \sigma$ ), -10 to +120 °C (14-248 °F)	$\pm 1$ K
Response time (63.2 % at 50 % FS flow)	250 ms
Resolution	0.1 K
<b>System conditions and environment</b>	
Liquid types	Aqueous media compatible with wetted materials. Kinematic viscosity $\leq 6$ mm <sup>2</sup> /s (cSt). See Appendix at the end of this document.
Maximum system pressure	30 bar (435 psig)
Burst pressure	40 bar (580 psig)
Liquid temperature, operation	-30 to +110 °C (-22 to +230 °F), non-freezing
Liquid temperature, peak	-30 to +110 °C (-22 to +230 °F), non-freezing
Ambient temperature, operation	-25 to +60 °C (-13 to +140 °F)
Ambient temperature, peak	-55 to +70 °C (-67 to +158 °F)
Storage temperature	-55 to +70 °C (-67 to +158 °F)
Humidity, relative	0-95 %, non-condensing
Pollution degree	3
Altitude	Max. 2000 m.a.s.l.
Location	If installed outdoors, we recommend that it is done in a protective shed or enclosure to avoid direct sunlight and rain.
<b>Electrical data</b>	
Power supply	12.5 - 30 VDC ( $\pm 5$ %)
Output signals	4-20 mA (4 mA at 0 m <sup>3</sup> /h, 4.8 mA at 12m <sup>3</sup> /h and 20 mA at 240 m <sup>3</sup> /h)
Signal cut off	21 mA
Maximum power consumption	660 mW
Maximum load impedance	60 $\Omega$ at 12.5 VDC
	100 $\Omega$ at 13.3 VDC
	600 $\Omega$ at 24 VDC
	900 $\Omega$ at 30 VDC
Maximum cable length	30 m (98 ft)
<b>Electrical data, VFI+T with temperature output</b>	
Power supply	16.6 - 30 VDC
Output signals	0-10 VDC (0 V at 0 m <sup>3</sup> /h, 0.5 V at 12 m <sup>3</sup> /h and 10 V at 240 m <sup>3</sup> /h) (0 V at -10 °C, 10 V at 120 °C)
Signal cut off	11 VDC
Maximum power consumption	270 mW
Maximum load impedance	10 k $\Omega$
Maximum cable length	30 m (98 ft)
<b>Materials</b>	
Sensing element	Silicon-based MEMS

O-ring	EPDM or FKM
Housing	Stainless steel 1.4404 (AISI 316 L)
Flow pipe	Stainless steel 1.4408 (AISI 316)
Flange, no liquid contact	Cast iron or stainless steel
Bluff body	Stainless steel 1.4401 (AISI 316 L)
Wetted materials	Corrosion-resistant coating, EPDM or FKM, Stainless steel 1.4401/04 /08 (AISI 316 L)
<b>Environmental standards</b>	
Enclosure class	IP67, cable connected
Temperature cycling	IEC 68-2-14
Vibration, non-destructive	20-2000 Hz, 10 G, 4 h
Electromagnetic compatibility	EN 61326-1
<b>Complete weight</b>	
With cast iron flanges, cable etc.	18.1 kg (39.8 lbs)
With stainless steel flanges, cable etc.	18.1 kg (39.8 lbs)

## 4. Vortex Flow sensor, Standard (VFS and VFS QT)

### General data



VFS and VFS QT sensors

### Technical overview

VFS is a combined flow and temperature sensor (two-in-one) from Grundfos Direct Sensors™. The sensor is based on the principle of vortex shedding behind a bluff body.

The VFS sensor is fully compatible with wet, aggressive media. The sensor is based on MEMS sensing technology in combination with the corrosion-resistant Silicoat® coating technology on the sensor chip.

The sensor is supplied with a flow pipe.

### Applications

- Pump control
- HVAC systems
- temperature control and chiller systems
- renewable energies such as heat pumps, solar thermals, fresh water and micro-CHP systems
- monitoring and control systems
- water treatment plants
- water utility and distribution systems
- HPC (High-Performance Computing) and IT cooling systems.

### Features and benefits

- Measurement principle with no movable parts, resulting in no wear and tear
- flow and temperature measurement in one sensor (two-in-one solution) for easy and cost-efficient installation
- MEMS technology
- direct contact with the aqueous media resulting in a fast response time
- plug and play for quick setup
- smart system solution with Grundfos pump controls
- compact and robust design
- compatible with aqueous media with a conductivity of 2 µS/cm or above<sup>3)</sup>
- suitable for a wide temperature range
- suitable for a wide range of application.

### Flow range

l/min	gpm
1 - 18	0.26 - 4.76
1.3 - 20	0.34 - 5.28
2 - 40	0.53 - 10.57
5 - 100	1.32 - 26.42
10 - 200	2.64 - 52.83
20 - 400	5.28 - 105.67

### Approvals (w/EPDM O-rings)

- WRAS
- AS 4020
- ACS.

### Compliance

- The versions with EPDM O-rings are compliant with the requirements of the evaluation criteria according to German drinking water regulations (UBA).

### Markings



CE

### Certificates



C, CSA, US

TM082829

TM021695

TM082909

**Electrical connections**

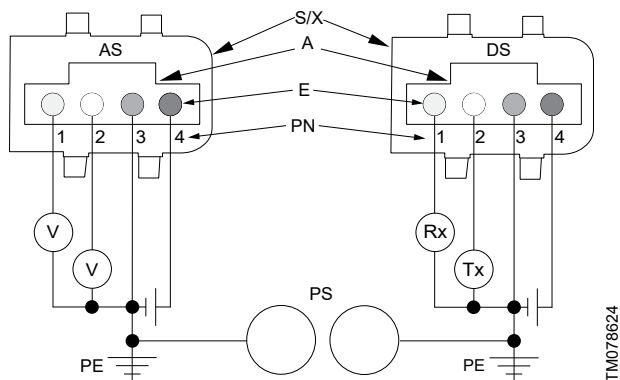

TM078624

*Electrical connections*

Pos.	Description
S/X	Snap-on connector
A	Standard connector
E	Electrical connector pins
PN	Pin No
PS	Pipe system
AS	Analog signal
DS	Digital signal
PE	Protective earth

Pin	Description Analog signal	Description Digital signal	Colour
1	Temperature signal	Rx	Yellow
2	Flow signal	Tx	White
3	GND, 0 V PELV	GND, 0 V PELV	Green
4	Voltage supply, +5 VDC	Power supply, +5 VDC	Brown

**Power supply requirements**

- 5 VDC ± 5 %, PELV.
- Ratiometric.
- Max. 10 mV ripple, 50 Hz.
- Min. output current: 25 mA.
- The sensors must be separated from hazardous live circuitry by double or reinforced insulation.
- Grounding of the sensor supply is required.

**Directives**

Grundfos Direct Sensors™ are in conformity with all applicable EU product legislation:

- EMC Directive (2014/30/EU)
  - Standards used: EN 61326-1:2013 and EN 61326-2-3:2013.
- RoHS Directive (2011/65/EU) and (2015/863/EU)
  - Standard used: EN IEC 63000:2018.

Grundfos Direct Sensors™ are not in the scope of:

- Pressure Equipment Directive (2014/68/EU) according to article 4, paragraph 3.
- Low Voltage Directive (2014/35/EU) because the supply voltage is below 75 VDC.

**VFS sensors**



TM054744

*The VFS family*

The VFS flow sensor consists of a composite flow pipe and a sensor fitted with cable.

The VFS flow sensor is available in 1-20, 2-40, 5-100, 10-200, 20-400 l/min versions.

**VFS QT sensors**



TM054743

*The VFS QT family*

The VFS QT flow sensor consists of a composite insert, a stainless steel flow pipe and a sensor fitted with cable.

The VFS QT flow sensor is available in 1-18, 2-40, 5-100, 10-200 l/min versions.

**Snap-on sensor**



TM054750

TM054752

**Differential temperature**

The differential temperature is between two standard Direct Sensors™ from Grundfos.

VFS, 1-20 l/min (0.3 - 5.3 gpm)



VFS, 1-20 l/min

Dimensions

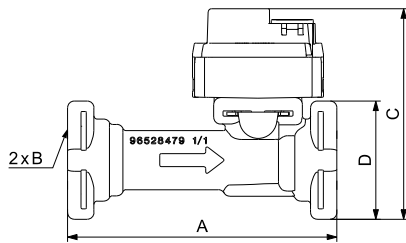

Dimensions, VFS, 1-20 l/min, without adapter

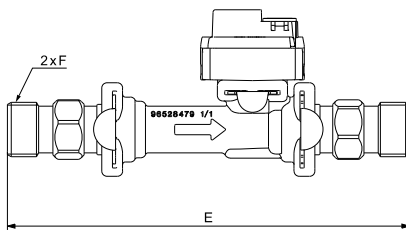

Dimensions, VFS, 1-20 l/min, with adapters

	A	B	C	D	E	F
mm	82	∅19.8	65	36	153.6	ISO 228 - G 1/2 A
in	3.23	∅0.78	2.56	1.42	6.05	1/2" NPT

Sensor output signals

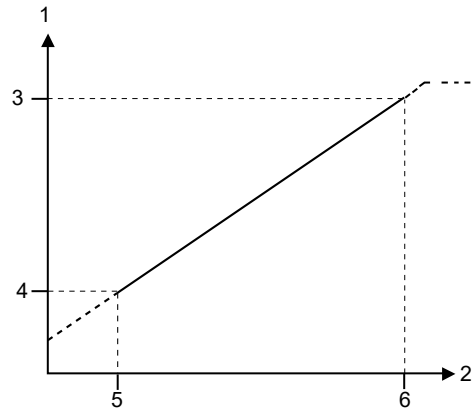

Flow response in analog mode

Pos.	Description
1	Flow output signal
2	Flow
3	3.5 V
4	0.55 V
5	$Q_{min}$
6	$Q_{max}$

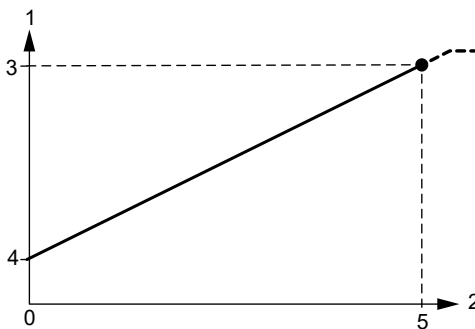

Temperature response in analog mode

Pos.	Description
0	$T_{min}$
1	Temperature output signal
2	Temperature
3	4.1 V
4	0.5 V
5	$T_{max}$

TM054751

TM062828

TM063420

TM063358

TM063425

## Specifications

<b>Flow</b>	
Measuring range ( $Q_{min}$ to $Q_{max}$ )	1.3 - 20 l/min (0.34 to 5.3 gpm)
Accuracy ( $\pm 1 \sigma$ ) in water, 0-120 °C (32-248 °F)	$\pm 1 \% FS$
Response time (63.2 %)	< 1 s
Resolution	$\frac{Q_{max}}{16384}$
<b>Temperature</b>	
Measuring range ( $T_{min}$ to $T_{max}$ )	0-120 °C (32-248 °F)
Accuracy ( $\pm 1 \sigma$ ), 15-90 °C (59-194 °F)	$\pm 0.5 K$
Accuracy ( $\pm 1 \sigma$ ), 0-120 °C (32-248 °F)	$\pm 1 K$
Response time (63.2 % at 50 % FS flow)	250 ms
Resolution	0.006 K
<b>Differential temperature</b>	
Accuracy 15-90 °C (59-194 °F)	0.3 K
Accuracy 0-120 °C (32-248 °F)	0.5 K
<b>System conditions and environment</b>	
Liquid types	Aqueous media compatible with wetted materials. Kinematic viscosity < 2 mm <sup>2</sup> /s (cSt)
Liquid temperature, operation	Water: 0-100 °C (32-212 °F)
Liquid temperature, peak	-25 °C (-13 °F), non-freezing 120 °C (248 °F) for 5 minutes, up to 3 weeks in sensor lifetime
Ambient temperature, operation	-25 to +60 °C (-13 to +140 °F)
Ambient temperature, peak	-55 to +90 °C (-67 to +194 °F)
Humidity, relative	0-95 %, non-condensing
Maximum system pressure	24 bar (348 psig)
Burst pressure	30 bar (435 psig)
Maximum system pressure examples	Max 10 bar (145 psig) at 100 °C (212 °F)
Pollution degree	3
Altitude	Max. 2000 m.a.s.l.
Location	If installed outdoors, we recommend that it is done in a protective shed or enclosure to avoid direct sunlight and rain.
<b>Electrical data</b>	
Power supply	5 VDC ( $\pm 5 \%$ ), PELV Grounding of sensor supply required
Output signals	Ratiometric
Digital output signals	Grundfos open data protocol
Analog output signals	0.5 - 3.5 V for flow (0.5 V at 1 l/min, 0.55 V at 1.3 l/min, 3.5 V at 20 l/min) 0.5 - 4.1 V for temperature (0.5 V at 0 °C, 4.1 V at 120 °C)
Power consumption	Appr. 75 mW
Load impedance	> 47 k $\Omega$
Maximum cable length	3 m (9.10 ft)
<b>Materials</b>	
Sensing element	Silicon-based MEMS
Sealing	EPDM O-rings, FKM O-rings or EPDM sealing sleeve with FKM O-rings
Housing	Composite (PPS, PA66)
Flow pipe	PPA 40-GF

Wetted materials	Corrosion-resistant coating , EPDM or FKM, PPS, PPA 40-GF
<b>Environmental standards</b>	
Enclosure class	IP44, cable connected
Temperature cycling	IEC 68-2-14
Vibration, non-destructive	20-2000 Hz, 10 G, 4 h
Electromagnetic compatibility	EN 61326-1

VFS, 2-40 l/min (0.5 - 10.6 gpm)



VFS, 2-40 l/min

Dimensions

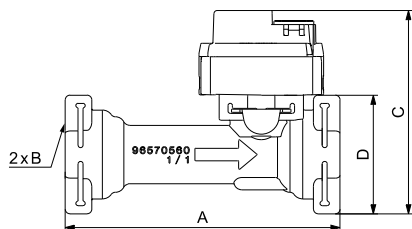

Dimensions, VFS, 2-40 l/min, without adapter

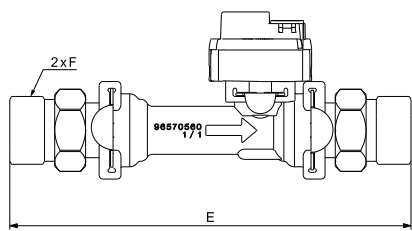

Dimensions, VFS, 2-40 l/min, with adapters

	A	B	C	D	E	F
mm	88	∅22.8	66	38	157.4	ISO 228/1 - G 3/4 A
in	3.46	∅0.19	2.60	1.50	6.20	3/4" NPT

Sensor output signals

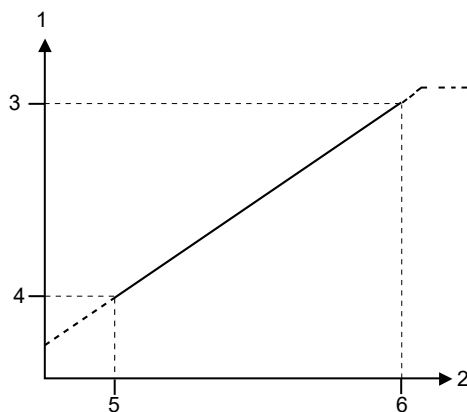

Flow response in analog mode

Pos.	Description
1	Flow output signal
2	Flow
3	3.5 V
4	0.5 V
5	Q <sub>min</sub>
6	Q <sub>max</sub>

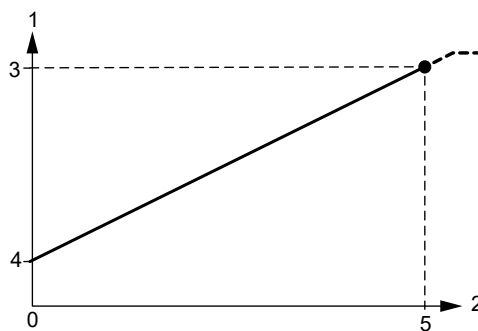

Temperature response in analog mode

Pos.	Description
0	T <sub>min</sub>
1	Temperature output signal
2	Temperature
3	4.1 V
4	0.5 V
5	T <sub>max</sub>

## Specifications

<b>Flow</b>	
Measuring range ( $Q_{min}$ to $Q_{max}$ )	2-40 l/min (0.5 - 10.6 gpm)
Accuracy ( $\pm 1 \sigma$ ) in water, 0-100 °C (32-212 °F)	$\pm 1 \% FS$
Response time (63.2 %)	< 1 s
Resolution	$\frac{Q_{max}}{16384}$
<b>Temperature</b>	
Measuring range ( $T_{min}$ to $T_{max}$ )	0-120 °C (32-248 °F)
Accuracy ( $\pm 1 \sigma$ ), 15-90 °C (59-194 °F)	$\pm 0.5 K$
Accuracy ( $\pm 1 \sigma$ ), 0-120 °C (32-248 °F)	$\pm 1 K$
Response time (63.2 % at 50 % FS flow)	250 ms
Resolution	0.006 K
<b>Differential temperature</b>	
Accuracy 15-90 °C (59-194 °F)	0.3 K
Accuracy 0-120 °C (32-248 °F)	0.5 K
<b>System conditions and environment</b>	
Liquid types	Aqueous media compatible with wetted materials. Kinematic viscosity $\leq 2 \text{ mm}^2/\text{s}$ (cSt)
Liquid temperature, operation	Water: 0-100 °C (32-212 °F)
Liquid temperature, peak	-25 °C (-13 °F), non-freezing 120 °C (248 °F) for 5 minutes, up to 3 weeks in sensor lifetime
Ambient temperature, operation	-25 to +60 °C (-13 to +140 °F)
Ambient temperature, peak	-55 to +90 °C (-67 to +194 °F)
Humidity, relative	0-95 %, non-condensing
Maximum system pressure	24 bar (348 psig)
Burst pressure	30 bar (435 psig)
Maximum system pressure examples	Max 10 bar (145 psig) at 100 °C (212 °F)
Pollution degree	3
Altitude	Max. 2000 m.a.s.l.
Location	If installed outdoors, we recommend that it is done in a protective shed or enclosure to avoid direct sunlight and rain.
<b>Electrical data</b>	
Power supply	5 VDC ( $\pm 5 \%$ ), PELV Grounding of sensor supply required
Output signals	Ratiometric
Digital output signals	Grundfos open data protocol
Analog output signals	0.5 - 3.5 V for flow (0.5 V at 2 l/min, 3.5 V at 40 l/min) 0.5 - 4.1 V for temperature (0.5 V at 0 °C, 4.1 V at 120 °C)
Power consumption	Appr. 75 mW
Load impedance	> 47 k $\Omega$
Maximum cable length	3 m (9.10 ft)
<b>Materials</b>	
Sensing element	Silicon-based MEMS
Sealing	EPDM -O-rings or FKM O-rings or EPDM sealing sleeve with FKM O-rings
Housing	Composite (PPS, PA66)
Flow pipe	PPA 40-GF

Wetted materials	Corrosion-resistant coating , EPDM or FKM, PPS, PPA 40-GF
<b>Environmental standards</b>	
Enclosure class	IP44, cable connected
Temperature cycling	IEC 68-2-14
Vibration, non-destructive	20-2000 Hz, 10 G, 4 h
Electromagnetic compatibility	EN 61326-1

### VFS, 5-100 l/min (1.3 - 26 gpm)



VFS, 5-100 l/min

#### Dimensions

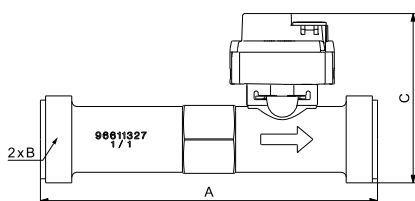

Dimensions, VFS, 5-100 l/min, without adapter

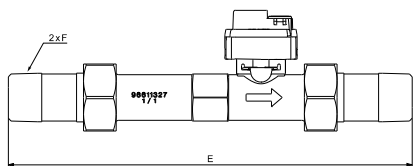

Dimensions, VFS, 5-100 l/min, with adapters

	A	B	C	D	E	F
mm	129	ISO 228/1 - G 1 A	65	-	223	ISO 7/1 - Rc 3/4
in	5.08		2.56	-	8.78	3/4" NPT

### Sensor output signals

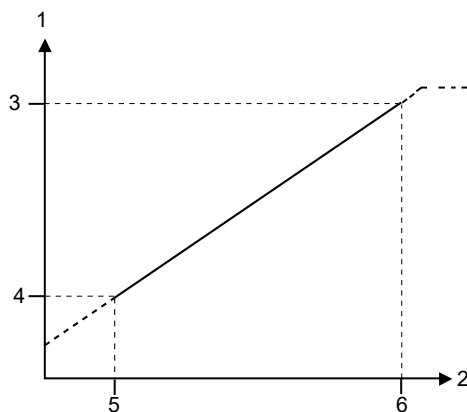

Flow response in analog mode

Pos.	Description
1	Flow output signal
2	Flow
3	3.5 V
4	0.5 V
5	Q <sub>min</sub>
6	Q <sub>max</sub>

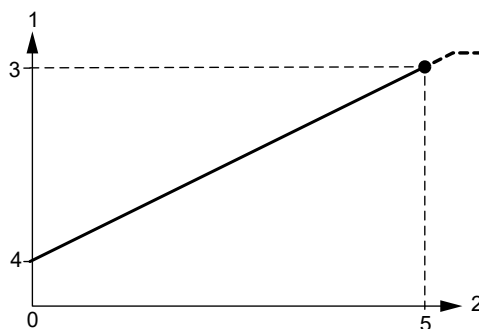

Temperature response in analog mode

Pos.	Description
0	T <sub>min</sub>
1	Temperature output signal
2	Temperature
3	4.1 V
4	0.5 V
5	T <sub>max</sub>

## Specifications

<b>Flow</b>	
Measuring range ( $Q_{min}$ to $Q_{max}$ )	5-100 l/min (1.3 to 26.4 gpm)
Accuracy ( $\pm 1 \sigma$ ) in water, 0-100 °C (32-212 °F)	$\pm 1 \% FS$
Response time (63.2 %)	< 1 s
Resolution	$\frac{Q_{max}}{16384}$
<b>Temperature</b>	
Measuring range ( $T_{min}$ to $T_{max}$ )	0-120 °C (32-248 °F)
Accuracy ( $\pm 1 \sigma$ ), 15-90 °C (59-194 °F)	$\pm 0.5 K$
Accuracy ( $\pm 1 \sigma$ ), 0-120 °C (32-248 °F)	$\pm 1 K$
Response time (63.2 % at 50 % FS flow)	250 ms
Resolution	0.006 K
<b>Differential temperature</b>	
Accuracy 15-90 °C (59-194 °F)	0.3 K
Accuracy 0-120 °C (32-248 °F)	0.5 K
<b>System conditions and environment</b>	
Liquid types	Aqueous media compatible with wetted materials. Kinematic viscosity $\leq 2 \text{ mm}^2/\text{s}$ (cSt)
Liquid temperature, operation	Water: 0-100 °C (32-212 °F)
Liquid temperature, peak	-25 °C (-13 °F), non-freezing 120 °C (248 °F) for 5 minutes, up to 3 weeks in sensor lifetime
Ambient temperature, operation	-25 to +60 °C (-13 to +140 °F)
Ambient temperature, peak	-55 to +90 °C (-67 to +194 °F)
Humidity, relative	0-95 %, non-condensing
Maximum system pressure	24 bar (348 psig)
Burst pressure	30 bar (435 psig)
Maximum system pressure examples	Max 10 bar (145 psig) at 100 °C (212 °F)
Pollution degree	3
Altitude	Max. 2000 m.a.s.l.
Location	If installed outdoors, we recommend that it is done in a protective shed or enclosure to avoid direct sunlight and rain.
<b>Electrical data</b>	
Power supply	5 VDC ( $\pm 5 \%$ ), PELV Grounding of sensor supply required
Output signals	Ratiometric
Digital output signals	Grundfos open data protocol
Analog output signals	0.5 - 3.5 V for flow (0.5 V at 5 l/min, 3.5 V at 100 l/min) 0.5 - 4.1 V for temperature (0.5 V at 0 °C, 4.1 V at 120 °C)
Power consumption	Appr. 75 mW
Load impedance	> 47 k $\Omega$
Maximum cable length	3 m (9.10 ft)
<b>Materials</b>	
Sensing element	Silicon-based MEMS
Sealing	EPDM O-rings, FKM O-rings or EPDM sealing sleeve with FKM O-rings
Housing	Composite (PPS, PA66)
Flow pipe	PPA 40-GF

Wetted materials	Corrosion-resistant coating , EPDM or FKM, PPS, PPA 40-GF
<b>Environmental standards</b>	
Enclosure class	IP44, cable connected
Temperature cycling	IEC 68-2-14
Vibration, non-destructive	20-2000 Hz, 10 G, 4 h
Electromagnetic compatibility	EN 61326-1

VFS, 10-200 l/min (2.6 - 53 gpm)



VFS, 10-200 l/min

Dimensions

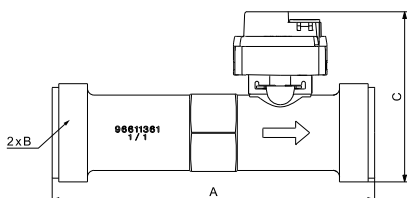

Dimensions, VFS, 10-200 l/min, without adapter

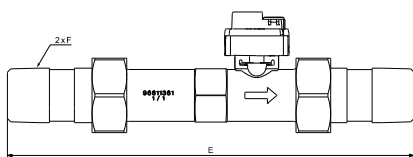

Dimensions, VFS, 10-200 l/min, with adapters

	A	B	C	D	E	F
mm	137.5	ISO 228/1 -	73	-	252	ISO 7/1-R 1
in	5.41	G 1 1/4 A	2.87	-	9.92	1" NPT

Sensor output signals

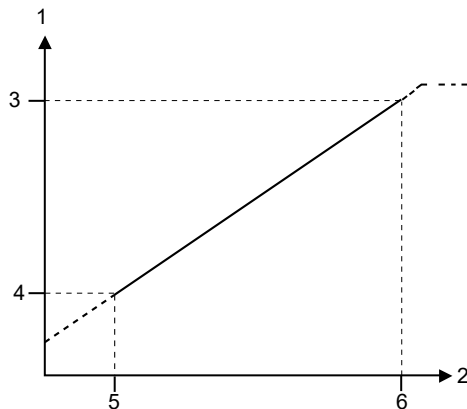

Flow response in analog mode

Pos.	Description
1	Flow output signal
2	Flow
3	3.5 V
4	0.5 V
5	Q <sub>min</sub>
6	Q <sub>max</sub>

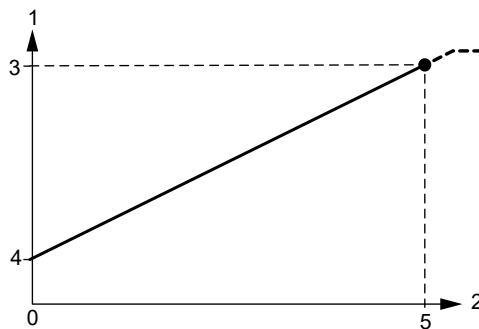

Temperature response in analog mode

Pos.	Description
0	T <sub>min</sub>
1	Temperature output signal
2	Temperature
3	4.1 V
4	0.5 V
5	T <sub>max</sub>

## Specifications

<b>Flow</b>	
Measuring range ( $Q_{min}$ to $Q_{max}$ )	10-200 l/min (2.6 to 52.8 gpm)
Accuracy ( $\pm 1 \sigma$ ) in water, 0-100 °C (32-212 °F)	$\pm 1 \% FS$
Response time (63.2 %)	< 1 s
Resolution	$\frac{Q_{max}}{16384}$
<b>Temperature</b>	
Measuring range ( $T_{min}$ to $T_{max}$ )	0-120 °C (32-248 °F)
Accuracy ( $\pm 1 \sigma$ ), 15-90 °C (59-194 °F)	$\pm 0.5 K$
Accuracy ( $\pm 1 \sigma$ ), 0-120 °C (32-248 °F)	$\pm 1 K$
Response time (63.2 % at 50 % FS flow)	250 ms
Resolution	0.35 K
<b>Differential temperature</b>	
Accuracy 15-90 °C (59-194 °F)	0.3 K
Accuracy 0-120 °C (32-248 °F)	0.5 K
<b>System conditions and environment</b>	
Liquid types	Aqueous media compatible with wetted materials. Kinematic viscosity $\leq 2 \text{ mm}^2/\text{s}$ (cSt)
Liquid temperature, operation	Water: 0-100 °C (32-212 °F)
Liquid temperature, peak	-25 °C (-13 °F), non-freezing 120 °C (248 °F) for 5 minutes, up to 3 weeks in sensor lifetime
Ambient temperature, operation	-25 to +60 °C (-13 to +140 °F)
Ambient temperature, peak	-55 to +90 °C (-67 to +194 °F)
Humidity, relative	0-95 %, non-condensing
Maximum system pressure	24 bar (348 psig)
Burst pressure	30 bar (435 psig)
Maximum system pressure examples	Max 10 bar (145 psig) at 100 °C (212 °F)
Pollution degree	3
Altitude	Max. 2000 m.a.s.l.
Location	If installed outdoors, we recommend that it is done in a protective shed or enclosure to avoid direct sunlight and rain.
<b>Electrical data</b>	
Power supply	5 VDC ( $\pm 5 \%$ ), PELV Grounding of sensor supply required
Output signals	Ratiometric
Digital output signals	Grundfos open data protocol
Analog output signals	0.5 - 3.5 V for flow (0.5 V at 10 l/min, 3.5 V at 200 l/min) 0.5 - 4.1 V for temperature (0.5 V at 0 °C, 4.1 V at 120 °C)
Power consumption	Appr. 75 mW
Load impedance	> 47 k $\Omega$
Maximum cable length	3 m (9.10 ft)
<b>Materials</b>	
Sensing element	Silicon-based MEMS
Sealing	EPDM -O-rings or FKM O-rings or EPDM sealing sleeve with FKM O-rings
Housing	Composite (PPS, PA66)
Flow pipe	PPA 40-GF

Wetted materials	Corrosion-resistant coating , EPDM or FKM, PPS, PPA 40-GF
<b>Environmental standards</b>	
Enclosure class	IP44, cable connected
Temperature cycling	IEC 68-2-14
Vibration, non-destructive	20-2000 Hz, 10 G, 4 h
Electromagnetic compatibility	EN 61326-1

### VFS, 20-400 l/min (5.3 - 106 gpm)



VFS, 20-400 l/min

#### Dimensions

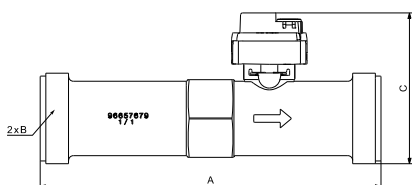

Dimensions, VFS, 20-400 l/min, without adapter

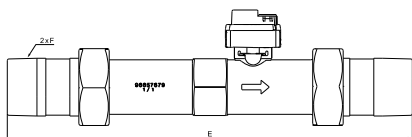

Dimensions, VFS 20-400 l/min, with adapters

	A	B	C	D	E	F
mm	180	ISO 228/1 - G 1 1/2 A	80	-	293	ISO 7/1- R 1 1/4
in	7.09		3.15	-	11.54	1 1/4" NPT

### Sensor output signals

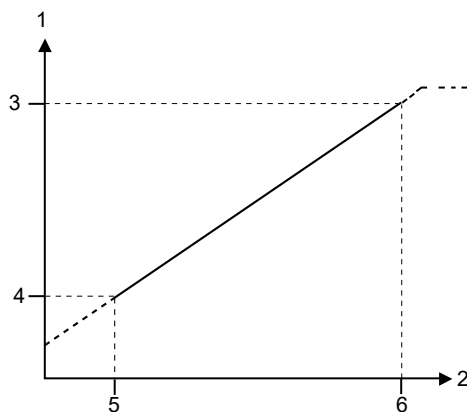

Flow response in analog mode

Pos.	Description
1	Flow output signal
2	Flow
3	3.5 V
4	0.5 V
5	Q <sub>min</sub>
6	Q <sub>max</sub>

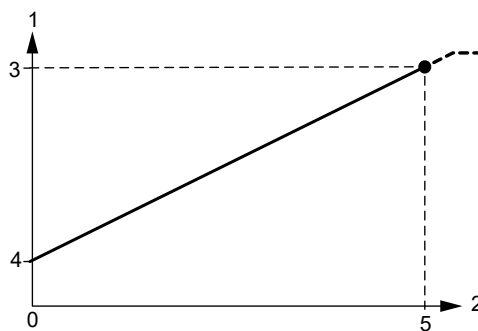

Temperature response in analog mode

Pos.	Description
0	T <sub>min</sub>
1	Temperature output signal
2	Temperature
3	4.1 V
4	0.5 V
5	T <sub>max</sub>

TM054746

TM082828

TM063424

TM063358

TM063429

## Specifications

<b>Flow</b>	
Measuring range ( $Q_{min}$ to $Q_{max}$ )	20-400 l/min (5.3 to 105.7 gpm)
Accuracy ( $\pm 1 \sigma$ ) in water, 0-120 °C (32-248 °F)	$\pm 1 \% FS$
Response time (63.2 %)	< 1 s
Resolution	$\frac{Q_{max}}{16384}$
<b>Temperature</b>	
Measuring range ( $T_{min}$ to $T_{max}$ )	0-120 °C (32-248 °F)
Accuracy ( $\pm 1 \sigma$ ), 15-90 °C (59-194 °F)	$\pm 0.5 K$
Accuracy ( $\pm 1 \sigma$ ), 0-120 °C (32-248 °F)	$\pm 1 K$
Response time (63.2 % at 50 % FS flow)	250 ms
Resolution	0.006 K
<b>Differential temperature</b>	
Accuracy 15-90 °C (59-194 °F)	0.3 K
Accuracy 0-120 °C (32-248 °F)	0.5 K
<b>System conditions and environment</b>	
Liquid types	Aqueous media compatible with wetted materials. Kinematic viscosity $\leq 2 \text{ mm}^2/\text{s}$ (cSt)
Liquid temperature, operation	Water: 0-100 °C (32-212 °F)
Liquid temperature, peak	-25 °C (-13 °F), non-freezing 120 °C (248 °F) for 5 minutes, up to 3 weeks in sensor lifetime
Ambient temperature, operation	-25 to +60 °C (-13 to +140 °F)
Ambient temperature, peak	-55 to +90 °C (-67 to +194 °F)
Humidity, relative	0-95 %, non-condensing
Maximum system pressure	24 bar (348 psig)
Burst pressure	30 bar (435 psig)
Maximum system pressure examples	Max 10 bar (145 psig) at 100 °C (212 °F)
Pollution degree	3
Altitude	Max. 2000 m.a.s.l.
Location	If installed outdoors, we recommend that it is done in a protective shed or enclosure to avoid direct sunlight and rain.
<b>Electrical data</b>	
Power supply	5 VDC ( $\pm 5 \%$ ), PELV Grounding of sensor supply required
Output signals	Ratiometric
Digital output signals	Grundfos open data protocol
Analog output signals	0.5 - 3.5 V for flow (0.5 V at 20 l/min, 3.5 V at 400 l/min) 0.5 - 4.1 V for temperature (0.5 V at 0 °C, 4.1 V at 120 °C)
Power consumption	Appr. 75 mW
Load impedance	> 47 k $\Omega$
Maximum cable length	3 m (9.10 ft)
<b>Materials</b>	
Sensing element	Silicon-based MEMS
Sealing	EPDM O-rings, FKM O-rings or EPDM sealing sleeve with FKM O-rings
Housing	Composite (PPS, PA66)
Flow pipe	PPA 40-GF

Wetted materials	Corrosion-resistant coating, EPDM or FKM, PPS, PPA 40-GF
<b>Environmental standards</b>	
Enclosure class	IP44, cable connected
Temperature cycling	IEC 68-2-14
Vibration, non-destructive	20-2000 Hz, 10 G, 4 h
Electromagnetic compatibility	EN 61326-1

## VFS QT, 0.5 - 10 l/min (0.13 - 2.6 gpm)



VFS QT, 0.5 - 10 l/min

### Dimensions

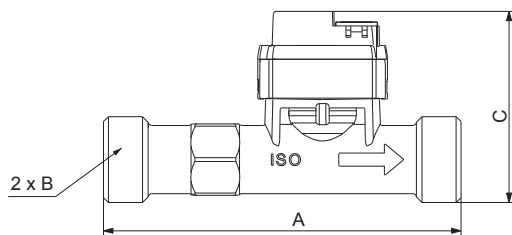

Dimensions, VFS QT, 0.5 - 10 l/min, with threads

	A	B	C
mm	110	ISO 228/1 - G3/4 A	58.8
in	4.33		2.31

### Sensor output signals

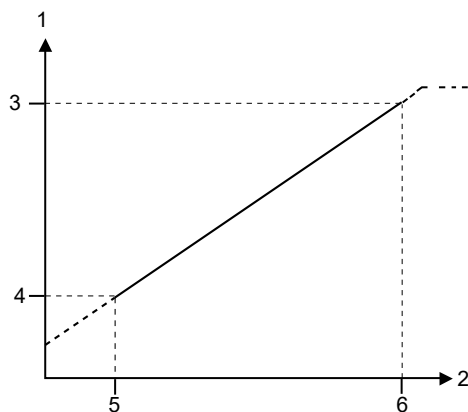

Flow response in analog mode

Pos.	Description
1	Flow output signal
2	Flow
3	3.5 V
4	0.5 V
5	$Q_{min}$
6	$Q_{max}$

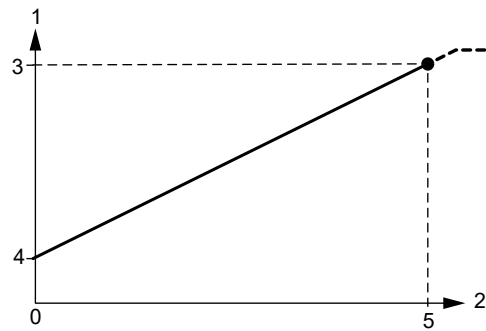

Temperature response in analog mode

Pos.	Description
0	$T_{min}$
1	Temperature output signal
2	Temperature
3	4.1 V
4	0.5 V
5	$T_{max}$

## Specifications

<b>Flow</b>	
Measuring range ( $Q_{min}$ to $Q_{max}$ )	0.5 - 10 l/min (0.13 - 2.6 gpm)
Accuracy ( $\pm 1 \sigma$ ) in water, 0-120 °C (32-248 °F)	$\pm 1$ % FS
Response time (63.2 %)	< 1 s
Resolution	$\frac{Q_{max}}{16384}$
<b>Temperature</b>	
Measuring range ( $T_{min}$ to $T_{max}$ )	0-120 °C (32-248 °F)
Accuracy ( $\pm 1 \sigma$ ), 15-90 °C (59-194 °F)	$\pm 0.5$ K
Accuracy ( $\pm 1 \sigma$ ), 0-120 °C (32-248 °F)	$\pm 1$ K
Response time (63.2 % at 50 % FS flow)	250 ms
Resolution	0.006 K
<b>Differential temperature</b>	
Accuracy 15-90 °C (59-194 °F)	0.3 K
Accuracy 0-120 °C (32-248 °F)	0.5 K
<b>System conditions and environment</b>	
Liquid types	Aqueous media compatible with wetted materials. Kinematic viscosity $\leq 2$ mm <sup>2</sup> /s (cSt)
Liquid temperature, operation	Water: 0-100 °C (32-212 °F)
Liquid temperature, peak	-10 °C (13 °F), non-freezing 120 °C (248 °F)
Ambient temperature, operation	-25 to +60 °C (-13 to +140 °F)
Ambient temperature, peak	-55 to +90 °C (-67 to +194 °F)
Humidity, relative	0-95 %, non-condensing
Maximum system pressure	30 bar (435 psig)
Burst pressure	40 bar (580 psig)
Maximum system pressure examples	Max 16 bar (232 psig) at 100 °C (212 °F) Max 8 bar (116 psig) at 120 °C (248 °F)
Pollution degree	3
Altitude	Max. 2000 m.a.s.l.
Location	If installed outdoors, we recommend that it is done in a protective shed or enclosure to avoid direct sunlight and rain.
<b>Electrical data</b>	
Power supply	5 VDC ( $\pm 5$ %), PELV Grounding of sensor supply required
Output signals	Ratiometric
Digital output signals	Grundfos open data protocol
Analog output signals	0.5 - 3.5 V for flow (0.5 V at 0.5 l/min, 3.5 V at 10 l/min) 0.5 - 4.1 V for temperature (0.5 V at 0 °C, 4.1 V at 120 °C)
Power consumption	360 mW at 0 °C, $V_{CC} = 24$ V 450 mW at 100 °C, $V_{CC} = 24$ V
Load impedance	> 47 k $\Omega$
Maximum cable length	3 m (9.10 ft)
<b>Materials</b>	
Sensing element	Silicon-based MEMS
Sealing	EPDM O-rings, FKM O-rings
Housing	Composite (PPS, PA66)

Flow pipe	Stainless steel AISI 316 EN 1.4408
Insert	PPA 40 GF
Wetted materials	Corrosion-resistant coating, EPDM or FKM, PPS, PPA 40-GF, 1.4408
<b>Environmental standards</b>	
Enclosure class	IP44, cable connected
Temperature cycling	IEC 68-2-14
Vibration, non-destructive	20-2000 Hz, 10 G, 4 h
Electromagnetic compatibility	EN 61326-1

## VFS QT, 1-18 l/min (0.3 - 4.8 gpm)



VFS QT, 1-18 l/min

### Dimensions

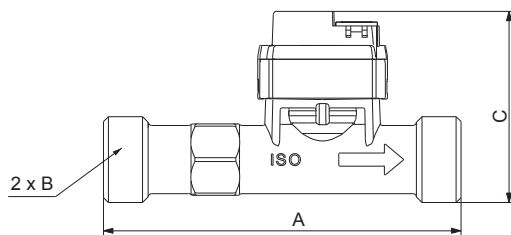

Dimensions, VFS QT, 1-18 l/min, with threads

	A	B	C
mm	110	ISO 228/1 - G3/4 A	58.8
in	4.33		2.31

### Sensor output signals

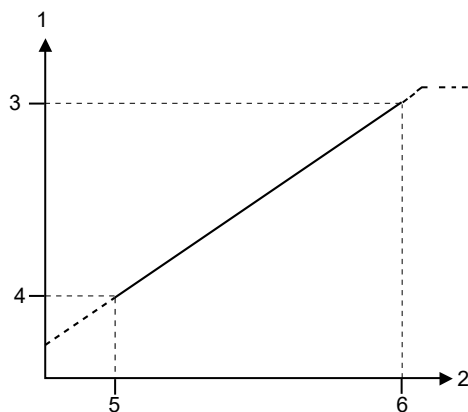

Flow response in analog mode

Pos.	Description
1	Flow output signal
2	Flow
3	4.14 V
4	0.5 V
5	$Q_{\min}$
6	$Q_{\max}$

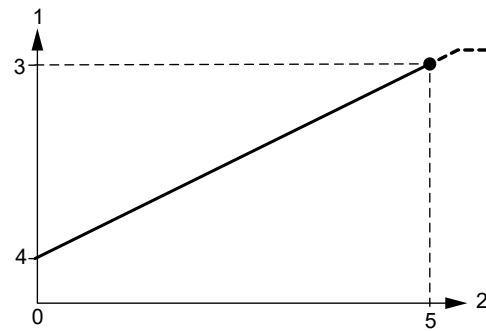

Temperature response in analog mode

Pos.	Description
0	$T_{\min}$
1	Temperature output signal
2	Temperature
3	4.1 V
4	0.5 V
5	$T_{\max}$

## Specifications

<b>Flow</b>	
Measuring range ( $Q_{\min}$ to $Q_{\max}$ )	1-18 l/min (0.3 - 4.8 gpm)
Accuracy ( $\pm 1 \sigma$ ) in water, 0-120 °C (32-248 °F)	$\pm 1$ % FS
Response time (63.2 %)	< 1 s
Resolution	$\frac{Q_{\max}}{16384}$
<b>Temperature</b>	
Measuring range ( $T_{\min}$ to $T_{\max}$ )	0-120 °C (32-248 °F)
Accuracy ( $\pm 1 \sigma$ ), 15-90 °C (59-194 °F)	$\pm 0.5$ K
Accuracy ( $\pm 1 \sigma$ ), 0-120 °C (32-248 °F)	$\pm 1$ K
Response time (63.2 % at 50 % FS flow)	250 ms
Resolution	0.006 K
<b>Differential temperature</b>	
Accuracy 15-90 °C (59-194 °F)	0.3 K
Accuracy 0-120 °C (32-248 °F)	0.5 K
<b>System conditions and environment</b>	
Liquid types	Aqueous media compatible with wetted materials. Kinematic viscosity $\leq 2$ mm <sup>2</sup> /s (cSt)
Liquid temperature, operation	Water: 0-120 °C (32-248 °F)
Liquid temperature, peak	-25 °C (-13 °F), non-freezing 120 °C (248 °F)
Ambient temperature, operation	-25 to +60 °C (-13 to +140 °F)
Ambient temperature, peak	-55 to +90 °C (-67 to +194 °F)
Humidity, relative	0-95 %, non-condensing
Maximum system pressure	30 bar (435 psig)
Burst pressure	40 bar (580 psig)
Maximum system pressure examples	Max 16 bar (232 psig) at 100 °C (212 °F) Max 8 bar (116 psig) at 120 °C (248 °F)
Pollution degree	3
Altitude	Max. 2000 m.a.s.l.
Location	If installed outdoors, we recommend that it is done in a protective shed or enclosure to avoid direct sunlight and rain.
<b>Electrical data</b>	
Power supply	5 VDC ( $\pm 5$ %), PELV Grounding of sensor supply required
Output signals	Ratiometric
Digital output signals	Grundfos open data protocol
Analog output signals	0.5 - 4.14 V for flow (0.5 V at 1 l/min, 4.14 V at 18 l/min) 0.5 - 4.1 V for temperature (0.5 V at 0 °C, 4.1 V at 120 °C)
Power consumption	Appr. 75 mW
Load impedance	> 47 k $\Omega$
Maximum cable length	3 m (9.10 ft)
<b>Materials</b>	
Sensing element	Silicon-based MEMS
Sealing	EPDM O-rings, FKM O-rings or EPDM sealing sleeve with FKM O-rings
Housing	Composite (PPS, PA66)

Flow pipe	Stainless steel AISI 316 EN 1.4408
Insert	PPA 40 GF
Wetted materials	Corrosion-resistant coating EPDM or FKM, PPS, PPA 40-GF, 1.4408
<b>Environmental standards</b>	
Enclosure class	IP44, cable connected
Temperature cycling	IEC 68-2-14
Vibration, non-destructive	20-2000 Hz, 10 G, 4 h
Electromagnetic compatibility	EN 61326-1

## VFS QT, 2-40 l/min (0.5 - 10.6 gpm)



VFS QT, 2-40 l/min

### Dimensions

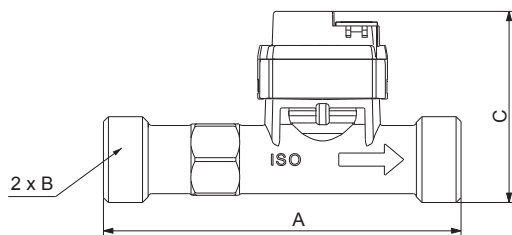

Dimensions, VFS QT, 2-40 l/min, with threads

	A	B	C
mm	110	ISO 228/1 - G3/4 A	58.8
in	4.33		2.31

### Sensor output signals

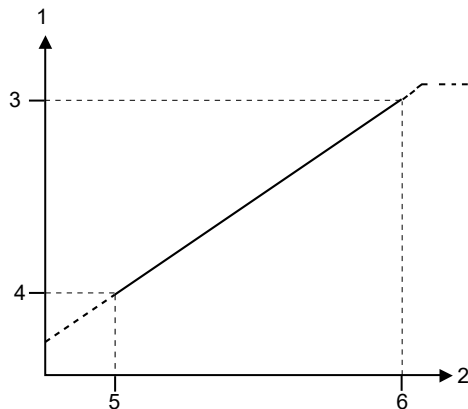

Flow response in analog mode

Pos.	Description
1	Flow output signal
2	Flow
3	3.5 V
4	0.5 V
5	$Q_{min}$
6	$Q_{max}$

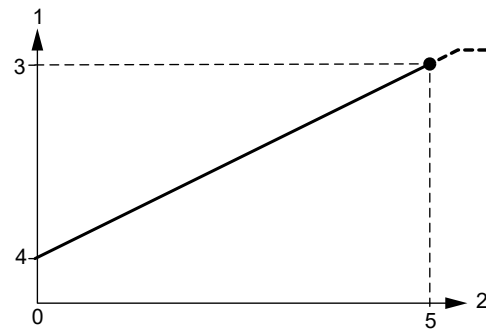

Temperature response in analog mode

Pos.	Description
0	$T_{min}$
1	Temperature output signal
2	Temperature
3	4.1 V
4	0.5 V
5	$T_{max}$

## Specifications

<b>Flow</b>	
Measuring range ( $Q_{\min}$ to $Q_{\max}$ )	2-40 l/min (0.5 - 10.6 gpm)
Accuracy ( $\pm 1 \sigma$ ) in water, 0-120 °C (32-248 °F)	$\pm 1$ % FS
Response time (63.2 %)	< 1 s
Resolution	$\frac{Q_{\max}}{16384}$
<b>Temperature</b>	
Measuring range ( $T_{\min}$ to $T_{\max}$ )	0-120 °C (32-248 °F)
Accuracy ( $\pm 1 \sigma$ ), 15-90 °C (59-194 °F)	$\pm 0.5$ K
Accuracy ( $\pm 1 \sigma$ ), 0-120 °C (32-248 °F)	$\pm 1$ K
Response time (63.2 % at 50 % FS flow)	250 ms
Resolution	0.006 K
<b>Differential temperature</b>	
Accuracy 15-90 °C (59-194 °F)	0.3 K
Accuracy 0-120 °C (32-248 °F)	0.5 K
<b>System conditions and environment</b>	
Liquid types	Aqueous media compatible with wetted materials. Kinematic viscosity $\leq 2$ mm <sup>2</sup> /s (cSt)
Liquid temperature, operation	Water: 0-100 °C (32-212 °F)
Liquid temperature, peak	-10 °C (13 °F), non-freezing 120 °C (248 °F)
Ambient temperature, operation	-25 to +60 °C (-13 to +140 °F)
Ambient temperature, peak	-55 to +90 °C (-67 to +194 °F)
Humidity, relative	0-95 %, non-condensing
Maximum system pressure	30 bar (435 psig)
Burst pressure	40 bar (580 psig)
Maximum system pressure examples	Max 16 bar (232 psig) at 100 °C (212 °F) Max 8 bar (116 psig) at 120 °C (248 °F)
Pollution degree	3
Altitude	Max. 2000 m.a.s.l.
Location	If installed outdoors, we recommend that it is done in a protective shed or enclosure to avoid direct sunlight and rain.
<b>Electrical data</b>	
Power supply	5 VDC ( $\pm 5$ %), PELV Grounding of sensor supply required
Output signals	Ratiometric
Digital output signals	Grundfos open data protocol
Analog output signals	0.5 - 3.5 V for flow (0.5 V at 2 l/min, 3.5 V at 40 l/min) 0.5 - 4.1 V for temperature (0.5 V at 0 °C, 4.1 V at 120 °C)
Power consumption	360 mW at 0 °C, $V_{CC} = 24$ V 450 mW at 100 °C, $V_{CC} = 24$ V
Load impedance	> 47 k $\Omega$
Maximum cable length	3 m (9.10 ft)
<b>Materials</b>	
Sensing element	Silicon-based MEMS
Sealing	EPDM O-rings, FKM O-rings or EPDM sealing sleeve with FKM O-rings
Housing	Composite (PPS, PA66)

Flow pipe	Stainless steel AISI 316 EN 1.4408
Insert	PPA 40 GF
Wetted materials	Corrosion-resistant coating, EPDM or FKM, PPS, PPA 40-GF, 1.4408
<b>Environmental standards</b>	
Enclosure class	IP44, cable connected
Temperature cycling	IEC 68-2-14
Vibration, non-destructive	20-2000 Hz, 10 G, 4 h
Electromagnetic compatibility	EN 61326-1

## VFS QT, 5-100 l/min (1.3 - 26 gpm)



VFS QT, 5-100 l/min

### Dimensions

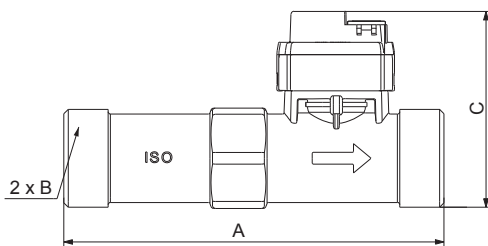

Dimensions, VFS QT, 5-100 l/min, with threads

	A	B	C
mm	129	ISO 228/1 - G1 A	66.5
in	5.08		2.62

### Sensor output signals

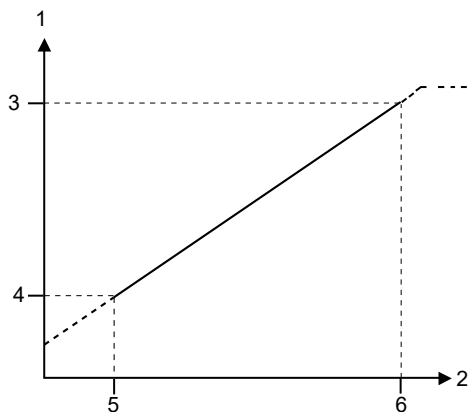

Flow response in analog mode

Pos.	Description
1	Flow output signal
2	Flow
3	3.5 V
4	0.5 V
5	$Q_{min}$
6	$Q_{max}$

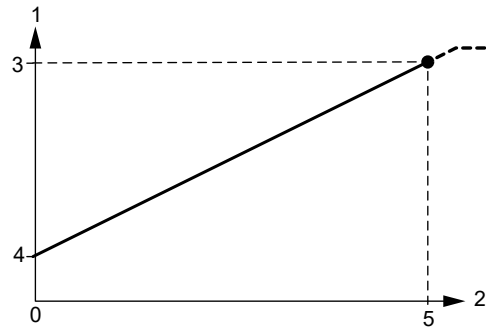

Temperature response in analog mode

Pos.	Description
0	$T_{min}$
1	Temperature output signal
2	Temperature
3	4.1 V
4	0.5 V
5	$T_{max}$

## Specifications

<b>Flow</b>	
Measuring range ( $Q_{min}$ to $Q_{max}$ )	5-100 l/min (1.3 to 26.4 gpm)
Accuracy ( $\pm 1 \sigma$ ), 0-100 °C (32-212 °F)	$\pm 1 \%$ FS
Response time (63.2 %)	< 1 s
Resolution	$\frac{Q_{max}}{16384}$
<b>Temperature</b>	
Measuring range ( $T_{min}$ to $T_{max}$ )	0-120 °C (32-248 °F)
Accuracy ( $\pm 1 \sigma$ ), 15-90 °C (59-194 °F)	$\pm 0.5$ K
Accuracy ( $\pm 1 \sigma$ ), 0-120 °C (32-248 °F)	$\pm 1$ K
Response time (63.2 % at 50 % FS flow)	250 ms
Resolution	0.006 K
<b>Differential temperature</b>	
Accuracy 15-90 °C (59-194 °F)	0.3 K
Accuracy 0-120 °C (32-248 °F)	0.5 K
<b>System conditions and environment</b>	
Liquid types	Aqueous media compatible with wetted materials. Kinematic viscosity $\leq 2 \text{ mm}^2/\text{s}$ (cSt)
Liquid temperature, operation	Water: 0-120 °C (32-248 °F)
Liquid temperature, peak	-25 °C (-13 °F), non-freezing 120 °C (248 °F)
Ambient temperature, operation	-25 to +60 °C (-13 to +140 °F)
Ambient temperature, peak	-55 to +90 °C (-67 to +194 °F)
Humidity, relative	0-95 %, non-condensing
Maximum system pressure	30 bar (435 psig)
Burst pressure	40 bar (580 psig)
Maximum system pressure examples	Max 16 bar (232 psig) at 100 °C (212 °F) Max 8 bar (116 psig) at 120 °C (248 °F)
Pollution degree	3
Altitude	Max. 2000 m.a.s.l.
Location	If installed outdoors, we recommend that it is done in a protective shed or enclosure to avoid direct sunlight and rain.
<b>Electrical data</b>	
Power supply	5 VDC ( $\pm 5 \%$ ). We recommend grounding of the sensor supply (PELV).
Output signals	Ratiometric
Digital output signals	Grundfos open data protocol
Analog output signals	0.5 - 3.5 V for flow (0.5 V at 5 l/min, 3.5 V at 100 l/min) 0.5 - 4.1 V for temperature (0.5 V at 0 °C, 4.1 V at 120 °C)
Power consumption	Appr. 75 mW
Load impedance	> 47 k $\Omega$
Maximum cable length	3 m (9.10 ft)
<b>Materials</b>	
Sensing element	Silicon-based MEMS
Sealing	EPDM O-rings, FKM O-rings or EPDM sealing sleeve with FKM O-rings
Housing	Composite (PPS, PA66)

Flow pipe	Stainless steel AISI 316 EN 1.4408
Insert	PPA 40-GF
Wetted materials	Corrosion-resistant coating, EPDM or FKM, PPS, PPA 40-GF, 1.4408
<b>Environmental standards</b>	
Enclosure class	IP44, cable connected
Temperature cycling	IEC 68-2-14
Vibration, non-destructive	20-2000 Hz, 10 G, 4 h
Electromagnetic compatibility	EN 61326-1

## VFS QT, 10-200 l/min (2.6 - 53 gpm)



VFS QT, 10-200 l/min

### Dimensions

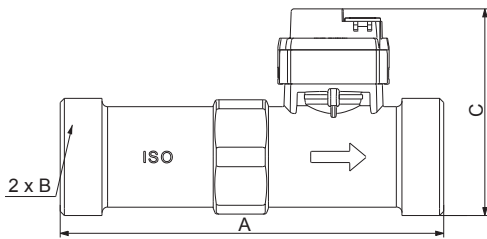

Dimensions, VFS QT, 10-200 l/min, with threads

	A	B	C
mm	137.5	ISO 228/1 - G1 1/4 A	74.1
in	5.41		2.92

### Sensor output signals

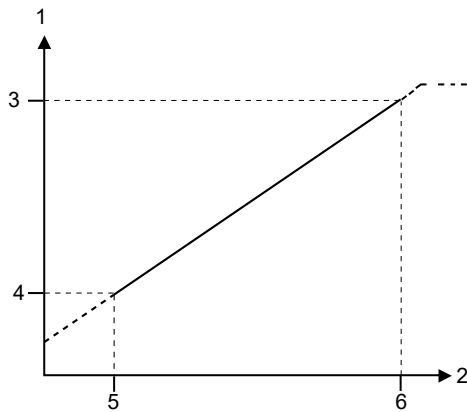

Flow response in analog mode

Pos.	Description
1	Flow output signal
2	Flow
3	3.5 V
4	0.5 V
5	$Q_{\min}$
6	$Q_{\max}$

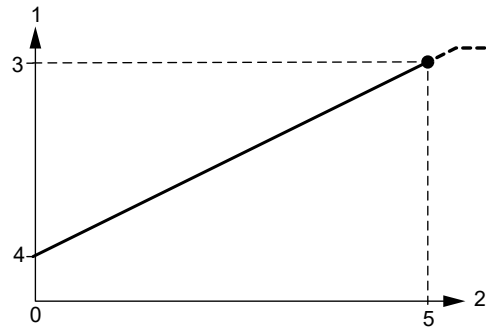

Temperature response in analog mode

Pos.	Description
0	$T_{\min}$
1	Temperature output signal
2	Temperature
3	4.1 V
4	0.5 V
5	$T_{\max}$

## Specifications

<b>Flow</b>	
Measuring range ( $Q_{\min}$ to $Q_{\max}$ )	10-200 l/min (2.6 to 52.8 gpm)
Accuracy ( $\pm 1 \sigma$ ) in water, 0-100 °C (32-212 °F)	$\pm 1$ % FS
Response time (63.2 %)	< 1 s
Resolution	$\frac{Q_{\max}}{16384}$
<b>Temperature</b>	
Measuring range ( $T_{\min}$ to $T_{\max}$ )	0-120 °C (32-248 °F)
Accuracy ( $\pm 1 \sigma$ ), 15-90 °C (59-194 °F)	$\pm 0.5$ K
Accuracy ( $\pm 1 \sigma$ ), 0-120 °C (32-248 °F)	$\pm 1$ K
Response time (63.2 % at 50 % FS flow)	250 ms
Resolution	0.006 K
<b>Differential temperature</b>	
Accuracy 15-90 °C (59-194 °F)	0.3 K
Accuracy 0-120 °C (32-248 °F)	0.5 K
<b>System conditions and environment</b>	
Liquid types	Aqueous media compatible with wetted materials. Kinematic viscosity $\leq 2$ mm <sup>2</sup> /s (cSt)
Liquid temperature, operation	Water: 0-120 °C (32-248 °F)
Liquid temperature, peak	-25 °C (-13 °F), non-freezing 120 °C (248 °F)
Ambient temperature, operation	-25 to +60 °C (-13 to +140 °F)
Ambient temperature, peak	-55 to +90 °C (-67 to +194 °F)
Humidity, relative	0-95 %, non-condensing
Maximum system pressure	30 bar (435 psig)
Burst pressure	40 bar (580 psig)
Maximum system pressure examples	Max 16 bar (232 psig) at 100 °C (212 °F) Max 8 bar (116 psig) at 120 °C (248 °F)
Pollution degree	3
Altitude	Max. 2000 m.a.s.l.
Location	If installed outdoors, we recommend that it is done in a protective shed or enclosure to avoid direct sunlight and rain.
<b>Electrical data</b>	
Power supply	5 VDC ( $\pm 5$ %), PELV Grounding of sensor supply required
Output signals	Ratiometric
Digital output signals	Grundfos open data protocol
Analog output signals	0.5 - 3.5 V for flow (0.5 V at 10 l/min, 3.5 V at 200 l/min) 0.5 - 4.1 V for temperature (0.5 V at 0 °C, 4.1 V at 120 °C)
Power consumption	Appr. 75 mW
Load impedance	> 47 k $\Omega$
Maximum cable length	3 m (9.10 ft)
<b>Materials</b>	
Sensing element	Silicon-based MEMS
Sealing	EPDM O-rings, FKM O-rings or EPDM sealing sleeve with FKM O-rings
Housing	Composite (PPS, PA66)
Flow pipe	Stainless steel 1.4408 (AISI 316)

Insert	PPA 40-GF
Wetted materials	Corrosion-resistant coating, EPDM or FKM, PPS, PPA 40-GF, 1.4408
<b>Environmental standards</b>	
Enclosure class	IP44, cable connected
Temperature cycling	IEC 68-2-14
Vibration, non-destructive	20-2000 Hz, 10 G, 4 h
Electromagnetic compatibility	EN 61326-1

## 5. Multi Flow sensor, Standard (MFS and MFS QT)

### General data



TM054752

TM054741

MFS and MFS QT

### Technical overview

MFS is a combined flow, pressure and temperature sensor (three-in-one) from Grundfos Direct Sensors™. The sensor is based on the principle of vortex shedding behind a bluff body.

The MFS sensor is designed for high-volume production and fully compatible with wet, aggressive media.

The sensor is based on MEMS sensing technology in combination with a unique packaging concept using corrosion-resistant coating on the MEMS sensor chip. This makes the sensor very robust and ideal for high-volume OEM (Original Equipment Manufacturer) applications.

### Applications

- Pump control
- HVAC systems
- temperature control and chiller systems
- renewable energies such as heat pumps, solar thermals, fresh water and micro-CHP systems
- monitoring and control systems
- water treatment plants
- water utility and distribution systems
- HPC (High-Performance Computing) and IT cooling systems.

### Features and benefits

- Flow, pressure and temperature measurement in one sensor (three-in-one solution) for easy and cost-efficient installation
- Measurement principle with no movable parts, resulting in no wear and tear

- self-configuring digital or analog output
- MEMS technology
- direct contact with the liquid resulting in a fast response time
- plug and play for quick setup
- smart system solution with Grundfos pump controls
- compact and robust design
- compatible with aqueous media with a conductivity of 2  $\mu\text{S}/\text{cm}$  or above<sup>4)</sup>
- suitable for a wide temperature range
- suitable for a wide range of application.

### Approvals (w/EPDM O-rings)

- WRAS
- ACS.

### Compliance

- The versions with EPDM O-rings are compliant with the requirements of the evaluation criteria according to German drinking water regulations (UBA).

### Markings



CE

TM021695

### Certificates



C, CSA, US

TM082909

**Electrical connections**

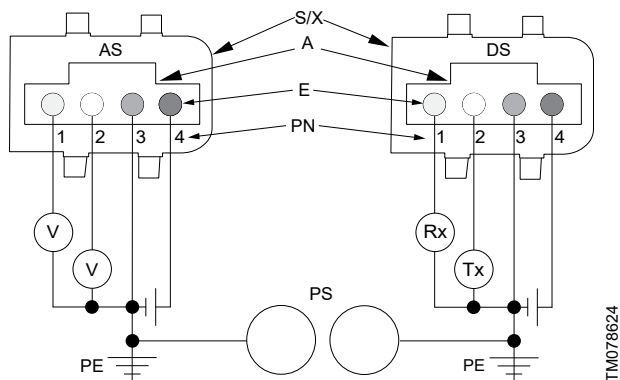

TM078624

*Electrical connections*

Pos.	Description
S/X	Snap-on connector
A	Standard connector
E	Electrical connector pins
PN	Pin No
PS	Pipe system
AS	Analog signal
DS	Digital signal
PE	Protective earth

	Pin configuration Analog signal	Pin configuration Digital signal	Colour
1	Analog signal 1	Rx	Yellow
2	Analog signal 2	Tx	White
3	GND (0 V), PELV	GND (0 V), PELV	Green
4	Power supply, + 5 VDC	Power supply, + 5 VDC	Brown

**Power supply requirements**

- 5 VDC ± 5 %, PELV
- maximum 10 mV ripple, 50 Hz
- minimum output current, 25 mA
- separated from hazardous live circuitry by double or reinforced insulation
- grounding of sensor supply is required.

**Directives**

Grundfos Direct Sensors™ are in conformity with all applicable EU product legislation:

- EMC Directive (2014/30/EU)
  - Standards used: EN 61326-1:2013 and EN 61326-2-3:2013.
- RoHS Directive (2011/65/EU) and (2015/863/EU)
  - Standard used: EN IEC 63000:2018.

Grundfos Direct Sensors™ are not in the scope of:

- Pressure Equipment Directive (2014/68/EU) according to article 4, paragraph 3.
- Low Voltage Directive (2014/35/EU) because the supply voltage is below 75 VDC.

**MFS sensors**



TM054744

*The MFS family*

The MFS flow sensor consists of a composite flow pipe and a sensor fitted with cable.

The MFS flow sensor is available in 2-20, 4-40, 10-100, 20-200, 40-400 l/min versions.

**MFS QT sensors**



TM054743

*The MFS QT family*

The MFS QT flow sensor consists of a composite insert, a stainless steel flow pipe and a sensor fitted with cable.

The MFS QT flow sensor is available in 2-18, 4-40, 10-100, 20-200 l/min versions.

**Snap-on sensor**



TM054750

TM054752

**Differential temperature**

The differential temperature is between two standard Direct Sensors™ from Grundfos.

### MFS 2-20 l/min (0.53 - 5.3 gpm)



MFS 2-20 l/min

#### Dimensions

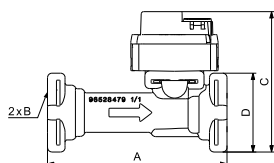

Dimensions, MFS 2-20 l/min, without adapter

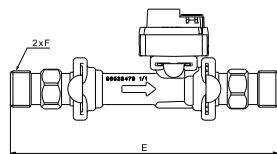

Dimensions, MFS 2-20 l/min, with adapters

	A	B	C	D	E	F
mm	82	∅19.8	65	36	153.6	ISO 228 - G 1/2 A
in	3.23	∅0.78	2.56	1.42	6.05	1/2" NPT

#### Sensor output signals

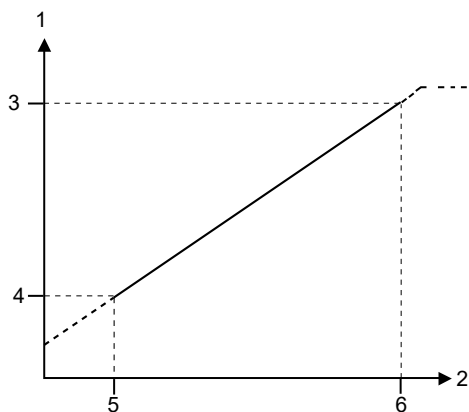

Flow response in Analog mode

Pos.	Description
1	Flow output signal
2	Flow
3	3.5 V
4	0.66 V
5	Q <sub>min</sub>
6	Q <sub>max</sub>

TM054751



TM063358

Temperature response in Analog mode

Pos.	Description
0	T <sub>min</sub>
1	Temperature output signal
2	Temperature
3	4.1 V
4	0.5 V
5	T <sub>max</sub>

TM063420

- Only two output signals are possible in Analog mode.  
As standard:
- Flow
  - Temperature.



TM063425

## Specifications

<b>Flow</b>	
Measuring range ( $Q_{min}$ to $Q_{max}$ )	2-20 l/min (0.53 to 5.3 gpm)
Accuracy ( $\pm 1 \sigma$ ) in water, 0-120 °C (32-248 °F)	$\pm 1 \% FS$
Response time (63.2 %)	< 4 s
Resolution	$\frac{Q_{max}}{16384}$
<b>Pressure</b>	
Measuring range ( $P_{min}$ to $P_{max}$ )	0-10 bar (0-145 psig)
Accuracy ( $\pm 1 \sigma$ ), 15-90 °C (59-194 °F)	$\pm 2.0 \% FS$
Accuracy ( $\pm 1 \sigma$ ), 0-120 °C (32-248 °F)	$\pm 2.5 \% FS$
Response time for sensor electronic	250 ms
Resolution	0.6 mbar (0.009 psig)
<b>Temperature</b>	
Measuring range ( $T_{min}$ to $T_{max}$ )	0-120 °C (32-248 °F)
Accuracy ( $\pm 1 \sigma$ ), 15-90 °C (59-194 °F)	$\pm 0.5 K$
Accuracy ( $\pm 1 \sigma$ ), 0-120 °C (32-248 °F)	$\pm 1 K$
Response time (63.2 % at 50 % FS flow)	250 m s
Resolution	0.006 K
<b>Differential temperature</b>	
Accuracy 15-90 °C (59-194 °F)	0.3 K
Accuracy 0-120 °C (32-248 °F)	0.5 K
<b>System conditions and environment</b>	
Liquids	Aqueous media compatible with wetted materials . Kinematic viscosity $\leq 2 \text{ mm}^2/\text{s}$ (cSt)
System temperature, operation	0-100 °C (32-212 °F)
System temperature, peak	-25 °C (-13 °F), non-freezing 120 °C (248 °F) for 5 minutes, up to 3 weeks in sensor lifetime
Ambient temperature, operation	-25 to +60 °C (-13 to +140 °F)
Ambient temperature, peak	-55 to +90 °C (-67 to +194 °F)
Humidity, relative	0-95 %, non-condensing
Maximum system pressure	24 bar (348 psig)
Burst pressure	30 bar (435 psig)
Maximum system pressure example	Max 10 bar (145 psig) at 100 °C (212 °F)
Pollution degree	3
Altitude	Max. 2000 m.a.s.l.
Location	If installed outdoors, we recommend that it is done in a protective shed or enclosure to avoid direct sunlight and rain.
<b>Electrical data</b>	
Power supply	5 VDC ( $\pm 5 \%$ ), PELV Grounding of sensor supply required
Digital output signals	Grundfos open data protocol
Analog output signals, only two signals possible (analog variants are upon request)	0.66 - 3.5 V for flow (0.66 V at 2 l/min, 3.5 V at 20 l/min) 0.5 - 4.1 V for temperature (0.5 V at 0 °C, 4.1 V at 120 °C)
Power consumption	Approximately 75 mW
Load impedance	> 47 k $\Omega$

### Materials

Sensing element	Silicon-based MEMS
Sealing	EPDM O-ring or FKM O-ring
Housing	Composite (PPS, PA66)
Flow pipe	PPA 40-GF
Wetted materials	Corrosion-resistant coating , EPDM or FKM , PPS, PPA 40-GF

### Environmental standards

Enclosure class	IP44, cable connected
Temperature cycling	IEC 68-2-14
Vibration, non-destructive	20-2000 Hz, 10 G, 4 h
Electromagnetic compatibility	EN 61326-1

### MFS 4-40 l/min (1.06 - 10.6 gpm)



MFS 4-40 l/min

#### Dimensions

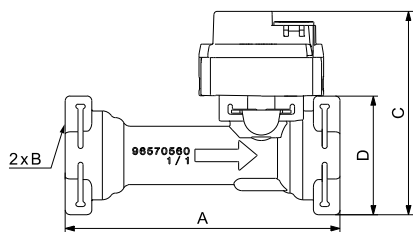

Dimensions, MFS 4-40 l/min, without adapter

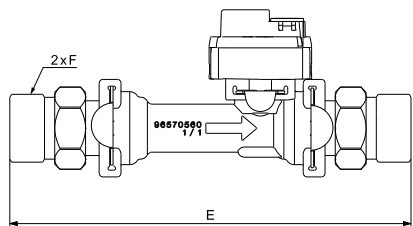

Dimensions, MFS 4-40 l/min, with adapter

	A	B	C	D	E	F
mm	88	∅22.8	66	38	157.4	ISO 228/1-G 3/4 A
in	3.46	∅0.19	2.60	1.50	6.20	3/4" NPT

#### Sensor output signals

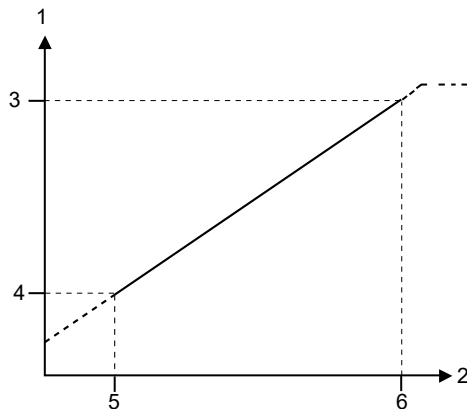

TM054749

TM082828

Flow response in Analog mode

Pos.	Description
1	Flow output signal
2	Flow
3	3.5 V
4	0.66 V
5	Q <sub>min</sub>
6	Q <sub>max</sub>

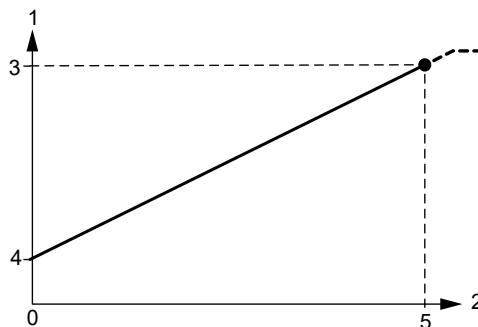

TM063421

TM063358

Temperature response in Analog mode

Pos.	Description
0	T <sub>min</sub>
1	Temperature output signal
2	Temperature
3	4.1 V
4	0.5 V
5	T <sub>max</sub>

Only two output signals are possible in Analog mode.  
As standard:

- Flow
- Temperature.



## Specifications

<b>Flow</b>	
Measuring range ( $Q_{min}$ to $Q_{max}$ )	4-40 l/min (1.06 - 10.6 gpm)
Accuracy ( $\pm 1 \sigma$ ) in water 0-120 °C (32-248 °F)	$\pm 1 \% FS$
Response time (63.2 %)	< 4 s
Resolution	$\frac{Q_{max}}{16384}$
<b>Pressure</b>	
Measuring range ( $P_{min}$ to $P_{max}$ )	0-10 bar (0-145 psig)
Accuracy ( $\pm 1 \sigma$ ), 15-90 °C (59-194 °F)	$\pm 2.0 \% FS$
Accuracy ( $\pm 1 \sigma$ ), 0-120 °C (32-248 °F)	$\pm 2.5 \% FS$
Response time for sensor electronic	250 ms
Resolution	0.6 mbar (0.009 psig)
<b>Temperature</b>	
Measuring range ( $T_{min}$ to $T_{max}$ )	0-120 °C (32-248 °F).
Accuracy ( $\pm 1 \sigma$ ), 15-90 °C (59-194 °F)	$\pm 0.5 K$
Accuracy ( $\pm 1 \sigma$ ), 0-120 °C (32-248 °F)	$\pm 1 K$
Response time (63.2 % at 50 % FS flow)	250 ms
Resolution	0.006 K
<b>System conditions and environment</b>	
Liquids	Aqueous media compatible with wetted materials . Kinematic viscosity $\leq 2 \text{ mm}^2/\text{s}$ (cSt)
System temperature, operation	0-100 °C (32-212 °F)
System temperature, peak	-25 °C (-13 °F), non-freezing 120 °C (248 °F) for 5 minutes, up to 3 weeks in sensor lifetime
Ambient temperature, operation	-25 to +60 °C (-13 to +140 °F)
Ambient temperature, peak	-55 to +90 °C (-67 to +194 °F)
Humidity, relative	0-95 %, non-condensing
Maximum system pressure	24 bar (348 psig)
Burst pressure	30 bar (435 psig)
Maximum system pressure example	Max 10 bar (145 psig) at 100 °C (212 °F)
Pollution degree	3
Altitude	Max. 2000 m.a.s.l.
Location	If installed outdoors, we recommend that it is done in a protective shed or enclosure to avoid direct sunlight and rain.
<b>Electrical data</b>	
Power supply	5 VDC ( $\pm 5 \%$ ), PELV Grounding of sensor supply required
Digital output signals	Grundfos open data protocol
Analog output signals, only two signals possible (analog variants are upon request)	0.66 - 3.5 V for flow (0.66 V at 4 l/min, 3.5 V at 40 l/min) 0.5 - 4.1 V for temperature (0.5 V at 0 °C, 4.1 V at 120 °C)
Power consumption	Approximately 75 mW
Load impedance	> 47 k $\Omega$
<b>Materials</b>	
Sensing element	Silicon-based MEMS
Sealing	EPDM O-ring or FKM O-ring

Housing	Composite (PPS, PA66)
Flow pipe	PPA 40-GF
Wetted materials	Corrosion-resistant coating , EPDM or FKM, PPS, PPA 40-GF
<b>Environmental standards</b>	
Enclosure class	IP44, cable connected
Temperature cycling	IEC 68-2-14
Vibration, non-destructive	20-2000 Hz, 10 G, 4 h
Electromagnetic compatibility	EN 61326-1

## MFS 10-100 l/min (2.6 - 26 gpm)



MFS 10-100 l/min

### Dimensions

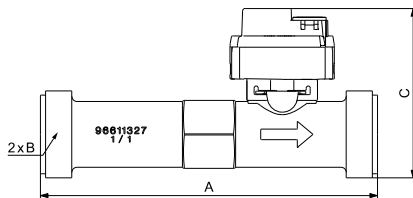

Dimensions, MFS 10-100 l/min, without adapter

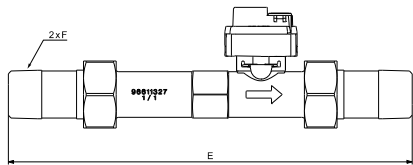

Dimensions, MFS 10-100 l/min, with adapters

	A	B	C	D	E	F
mm	129	ISO 228/1 -	65	-	223	ISO 7/1-Rc 3/4
in	5.08	G 1 A	2.56	-	8.78	3/4" NPT

### Sensor output signals

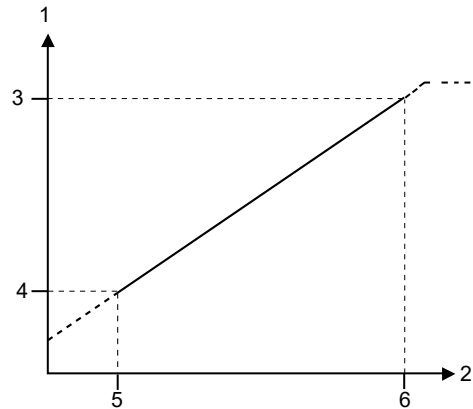

Flow response in Analog mode

Pos.	Description
1	Flow output signal
2	Flow
3	3.5 V
4	0.66 V
5	$Q_{min}$
6	$Q_{max}$

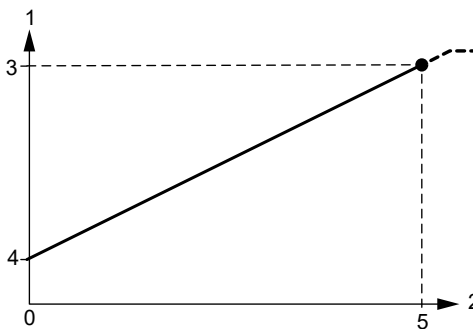

Temperature response in Analog mode

Pos.	Description
0	$T_{min}$
1	Temperature output signal
2	Temperature
3	4.1 V
4	0.5 V
5	$T_{max}$

Only two output signals are possible in Analog mode.



As standard:

- Flow
- Temperature.

## Specifications

<b>Flow</b>	
Measuring range ( $Q_{min}$ to $Q_{max}$ )	10-100 l/min (2.6-26 gpm)
Accuracy ( $\pm 1 \sigma$ ) in water 0-120 °C (32-248 °F)	$\pm 1 \% FS$
Response time (63.2 %)	< 4 s
Resolution	$\frac{Q_{max}}{16384}$
<b>Pressure</b>	
Measuring range ( $P_{min}$ to $P_{max}$ )	0-10 bar (0-145 psig)
Accuracy ( $\pm 1 \sigma$ ), 15-90 °C (59-194 °F)	$\pm 2.0 \% FS$
Accuracy ( $\pm 1 \sigma$ ), 0-120 °C (32-248 °F)	$\pm 2.5 \% FS$
Response time for sensor electronic	250 ms
Resolution	0.6 mbar (0.009 psig)
<b>Temperature</b>	
Measuring range ( $T_{min}$ to $T_{max}$ )	0-120 °C (32-248 °F)
Accuracy ( $\pm 1 \sigma$ ), 15-90 °C (59-194 °F)	$\pm 0.5 K$
Accuracy ( $\pm 1 \sigma$ ), 0-100 °C (32-212 °F)	$\pm 1 K$
Response time (63.2 % at 50 % FS flow)	250 ms
Resolution	0.006 K
<b>Differential temperature</b>	
Accuracy 15-90 °C (59-194 °F)	0.3 K
Accuracy 0-120 °C (32-248 °F)	0.5 K
<b>System conditions and environment</b>	
Liquid types	Aqueous media compatible with wetted materials . Kinematic viscosity $\leq 2 \text{ mm}^2/\text{s}$ (cSt)
System temperature, operation	0-100 °C (32-212 °F)
System temperature, peak	-25 °C (-13 °F), non-freezing 120 °C (248 °F) for 5 minutes, up to 3 weeks in sensor lifetime
Ambient temperature, operation	-25 to +60 °C (-13 to +140 °F)
Ambient temperature, peak	-55 to +90 °C (-67 to +194 °F)
Humidity, relative	0-95 %, non-condensing
Maximum system pressure	24 bar (348 psig)
Burst pressure	30 bar (435 psig)
Maximum system pressure example	Max 10 bar (145 psig) at 100 °C (212 °F)
Pollution degree	3
Altitude	Max. 2000 m.a.s.l.
Location	If installed outdoors, we recommend that it is done in a protective shed or enclosure to avoid direct sunlight and rain.
<b>Electrical data</b>	
Power supply	5 VDC ( $\pm 5 \%$ ), PELV Grounding of sensor supply required
Digital output signals	Grundfos open data protocol
Analog output signals, only two signals possible (analog variants are upon request)	0.66 - 3.5 V for flow (0.66 V at 10 l/ min, 3.5 V at 100 l/min) 0.5 - 4.1 V for temperature (0.5 V at 0 °C, 4.1 V at 120 °C)
Power consumption	Approximately 75 mW
Load impedance	> 47 k $\Omega$

### Materials

Sensing element	Silicon-based MEMS
Sealing	EPDM O-ring or FKM O-ring
Housing	Composite (PPS, PA66)
Flow pipe	PPA 40-GF
Wetted materials	Corrosion-resistant coating , EPDM or FKM , PPS, PPA 40-GF

### Environmental standards

Enclosure class	IP44, cable connected
Temperature cycling	IEC 68-2-14
Vibration, non-destructive	20-2000 Hz, 10 G, 4 h
Electromagnetic compatibility	EN 61326-1

### MFS 20-200 l/min (5.3 - 53 gpm)



MFS 20-200 l/min

#### Dimensions

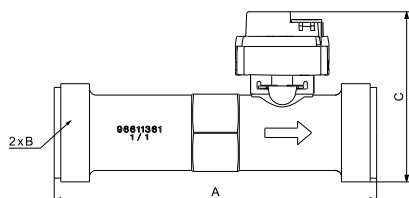

Dimensions, MFS 20-200 l/min, without adapter

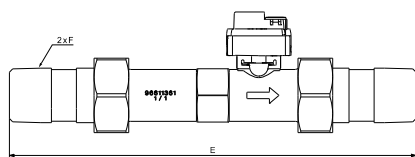

Dimensions, MFS 20-200 l/min, with adapters

	A	B	C	D	E	F
mm	137.5	ISO 228/1 -	73	-	252	ISO 7/1-R 1
in	5.41	G 1 1/4 A	2.87	-	9.92	1" NPT

#### Sensor output signals

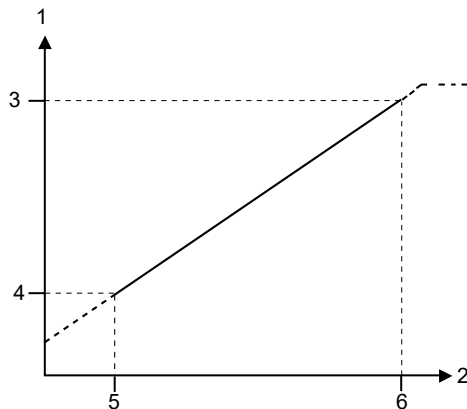

Flow response in Analog mode

Pos.	Description
1	Flow output signal
2	Flow
3	3.5 V
4	0.66 V
5	Q <sub>min</sub>
6	Q <sub>max</sub>

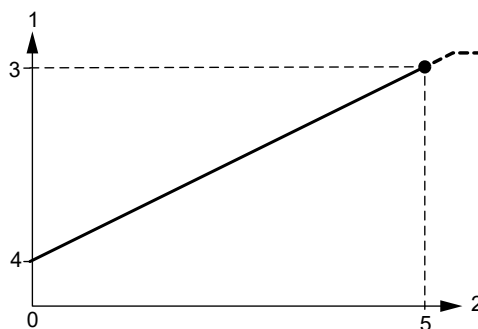

Temperature response in Analog mode

Pos.	Description
0	T <sub>min</sub>
1	Temperature output signal
2	Temperature
3	4.1 V
4	0.5 V
5	T <sub>max</sub>

Only two output signals are possible in Analog mode.



As standard:

- Flow
- Temperature.

## Specifications

<b>Flow</b>	
Measuring range ( $Q_{min}$ to $Q_{max}$ )	20-200 l/min (5.3 - 53 gpm)
Accuracy ( $\pm 1 \sigma$ ) in water 0-120 °C (32-248 °F)	$\pm 1 \% FS$
Response time (63.2 %)	< 4 s
Resolution	$\frac{Q_{max}}{16384}$
<b>Pressure</b>	
Measuring range ( $P_{min}$ to $P_{max}$ )	0-10 bar (0-145 psig)
Accuracy ( $\pm 1 \sigma$ ), 15-90 °C (59-194 °F)	$\pm 2.0 \% FS$
Accuracy ( $\pm 1 \sigma$ ), 0-120 °C (32-248 °F)	$\pm 2.5 \% FS$
Response time for sensor electronic	250 ms
Resolution	0.6 mbar (0.009 psig)
<b>Temperature</b>	
Measuring range ( $T_{min}$ to $T_{max}$ )	0-120 °C (32-248 °F)
Accuracy ( $\pm 1 \sigma$ ), 15-90 °C (59-194 °F)	$\pm 0.5 K$
Accuracy ( $\pm 1 \sigma$ ), 0-120 °C (32-248 °F)	$\pm 1 K$
Response time (63.2 % at 50 % FS flow)	250 ms
Resolution	0.006 K
<b>Differential temperature</b>	
Accuracy 15-90 °C (59-194 °F)	0.3 K
Accuracy 0-120 °C (32-248 °F)	0.5 K
<b>System conditions and environment</b>	
Liquid types	Aqueous media compatible with wetted materials Kinematic viscosity $\leq 2 \text{ mm}^2/\text{s}$ (cSt)
System temperature, operation	0-100 °C (32-212 °F)
System temperature, peak	-25 °C (-13 °F), non-freezing 120 °C (248 °F) for 5 minutes, up to 3 weeks in sensor lifetime
Ambient temperature, operation	-25 to +60 °C (-13 to +140 °F)
Ambient temperature, peak	-55 to +90 °C (-67 to +194 °F)
Humidity, relative	0-95 %, non-condensing
Maximum system pressure	24 bar (348 psig)
Burst pressure	30 bar (435 psig)
Maximum system pressure example	Max 10 bar (145 psig) at 100 °C (212 °F)
Pollution degree	3
Altitude	Max. 2000 m.a.s.l.
Location	If installed outdoors, we recommend that it is done in a protective shed or enclosure to avoid direct sunlight and rain.
<b>Electrical data</b>	
Power supply	5 VDC ( $\pm 5 \%$ ), PELV Grounding of sensor supply required
Digital output signals	Grundfos open data protocol
Analog output signals, only two signals possible (analog variants are upon request)	0.66 - 3.5 V for flow (0.66 V at 20 l/ min, 3.5 V at 200 l/min) 0.5 - 4.1 V for temperature (0.5 V at 0 °C, 4.1 V at 120 °C)
Power consumption	Approximately 75 mW
Load impedance	> 47 k $\Omega$

### Materials

Sensing element	Silicon-based MEMS
Sealing	EPDM O-ring or FKM O-ring
Housing	Composite (PPS, PA66)
Flow pipe	PPA 40-GF
Wetted materials	Corrosion-resistant coating , EPDM or FKM, PPS, PPA 40-GF

### Environmental standards

Enclosure class	IP44, cable connected
Temperature cycling	IEC 68-2-14
Vibration, non-destructive	20-2000 Hz, 10 G, 4 h
Electromagnetic compatibility	EN 61326-1

### MFS 40-400 l/min (10.6 - 106 gpm)



MFS 40-400 l/min

#### Dimensions

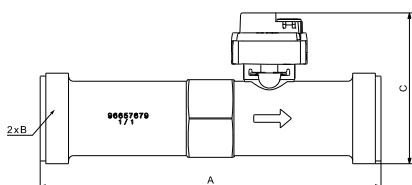

Dimensions, MFS 40-400 l/min, without adapter

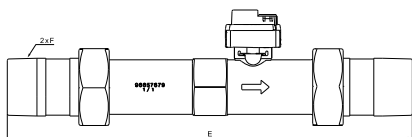

Dimensions, MFS 40-400 l/min, with adapters

	A	B	C	D	E	F
mm	180	ISO 228/1 -	80	-	293	ISO 7/1- R 1 1/4
in	7.09	G 1 1/2 A	3.15	-	11.54	1 1/4" NPT

TM054746

TM063424

TM063429

#### Sensor output signals

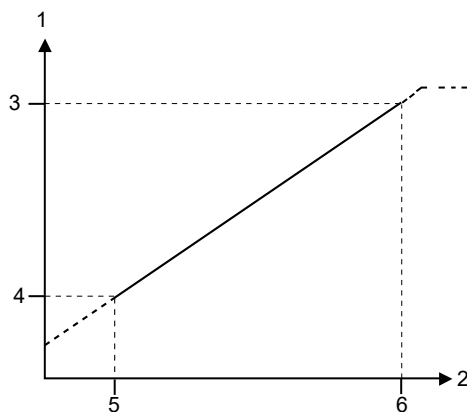

Flow response in Analog mode

Pos.	Description
1	Flow output signal
2	Flow
3	3.5 V
4	0.66 V
5	$Q_{min}$
6	$Q_{max}$

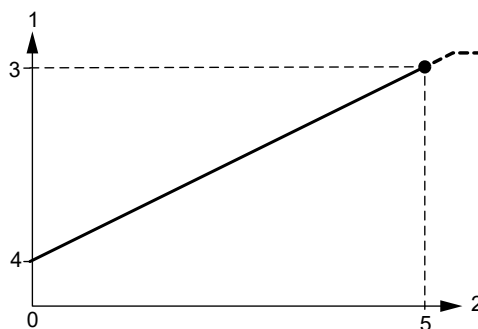

Temperature response in Analog mode

Pos.	Description
0	$T_{min}$
1	Temperature output signal
2	Temperature
3	4.1 V
4	0.5 V
5	$T_{max}$

Only two output signals are possible in Analog mode.



As standard:

- Flow
- Temperature.

TM062828

TM063358

## Specifications

<b>Flow</b>	
Measuring range ( $Q_{\min}$ to $Q_{\max}$ )	40-400 l/min (10.6 - 106 gpm)
Accuracy ( $\pm 1 \sigma$ , in water 0-120 °C (32-248 °F))	$\pm 1 \% \text{ FS}$
Response time (63.2 %)	< 4 s
Resolution	$\frac{Q_{\max}}{16384}$
<b>Pressure</b>	
Measuring range ( $P_{\min}$ to $P_{\max}$ )	0-10 bar (0-145 psig)
Accuracy ( $\pm 1 \sigma$ ), 15-90 °C (59-194 °F)	$\pm 2.0 \% \text{ FS}$
Accuracy ( $\pm 1 \sigma$ ), 0-120 °C (32-248 °F)	$\pm 2.5 \% \text{ FS}$
Response time for sensor electronic	250 ms
Resolution	0.6 mbar (0.009 psig)
<b>Temperature</b>	
Measuring range ( $T_{\min}$ to $T_{\max}$ )	0-120 °C (32-248 °F)
Accuracy ( $\pm 1 \sigma$ ), 15-90 °C (59-194 °F)	$\pm 0.5 \text{ K}$
Accuracy ( $\pm 1 \sigma$ ), 0-120 °C (32-248 °F)	$\pm 1 \text{ K}$
Response time (63.2 % at 50 % FS flow)	250 ms
Resolution	0.006 K
<b>Differential temperature</b>	
Accuracy 15-90 °C (59-194 °F)	0.3 K
Accuracy 0-120 °C (32-248 °F)	0.5 K
<b>System conditions and environment</b>	
Liquid types	Aqueous media compatible with wetted materials . Kinematic viscosity $\leq 2 \text{ mm}^2/\text{s}$ (cSt)
System temperature, operation	0-100 °C (32-212 °F)
System temperature, peak	-25 °C (-13 °F), non-freezing 120 °C (248 °F) for 5 minutes, up to 3 weeks in sensor lifetime
Ambient temperature, operation	-25 to +60 °C (-13 to +140 °F)
Ambient temperature, peak	-55 to +90 °C (-67 to +194 °F)
Humidity, relative	0-95 %, non-condensing
Maximum system pressure	24 bar (348 psig)
Burst pressure	30 bar (435 psig)
Maximum system pressure example	Max 10 bar (145 psig) at 100 °C (212 °F)
Pollution degree	3
Altitude	Max. 2000 m.a.s.l.
Location	If installed outdoors, we recommend that it is done in a protective shed or enclosure to avoid direct sunlight and rain.
<b>Electrical data</b>	
Power supply	5 VDC ( $\pm 5 \%$ ), PELV Grounding of sensor supply required
Digital output signals	Grundfos open data protocol
Analog output signals, only two signals possible (analog variants are upon request)	0.66 - 3.5 V for flow (0.66 V at 40 l/ min, 3.5 V at 400 l/min) 0.5 - 4.1 V for temperature (0.5 V at 0 °C, 4.1 V at 120 °C)
Power consumption	Approximately 75 mW
Load impedance	> 47 k $\Omega$

### Materials

Sensing element	Silicon-based MEMS
Sealing	EPDM O-ring or FKM O-ring
Housing	Composite (PPS, PA66)
Flow pipe	PPA 40-GF
Wetted materials	Corrosion-resistant coating , EPDM or FKM, PPS, PPA 40-GF

### Environmental standards

Enclosure class	IP44, cable connected
Temperature cycling	IEC 68-2-14
Vibration, non-destructive	20-2000 Hz, 10 G, 4 h
Electromagnetic compatibility	EN 61326-1

## MFS QT 2-18 l/min (0.39 - 4.8 gpm)



TM054741

MFS QT 2-18 l/min

### Dimensions

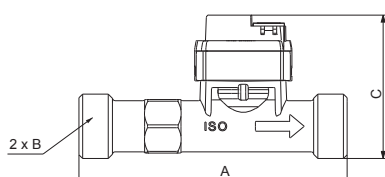

TM054671

Dimensions, MFS QT 2-18 l/min, with threads

	A	B	C
mm	110	ISO 228/1 - G3/4 A	58.8
in	4.33		2.31

### Sensor output signals

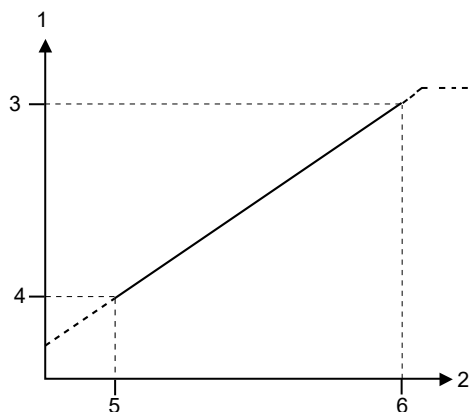

TM082828

Flow response in Analog mode

Pos.	Description
1	Flow output signal
2	Flow
3	4.14 V
4	0.71 V
5	$Q_{\min}$
6	$Q_{\max}$

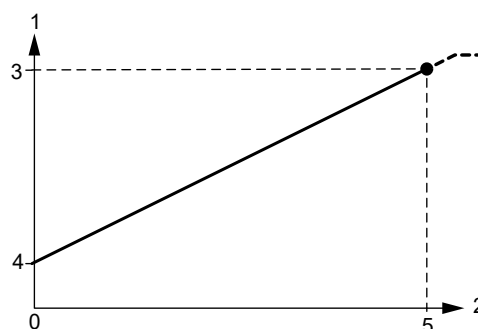

TM063358

Temperature response in Analog mode

Pos.	Description
0	$T_{\min}$
1	Temperature output signal
2	Temperature
3	4.1 V
4	0.5 V
5	$T_{\max}$



Only two output signals are possible in Analog mode.

As standard:

- Flow
- Temperature.

## Specifications

<b>Flow</b>	
Measuring range ( $Q_{min}$ to $Q_{max}$ )	2-18 l/min (0.39 - 4.8 gpm)
Accuracy ( $\pm 1 \sigma$ ) in water, 0-120 °C (32-248 °F)	$\pm 1 \%$ FS
Response time (63.2 %)	< 4 s
Resolution	$\frac{Q_{max}}{16384}$
<b>Pressure</b>	
Measuring range ( $P_{min}$ to $P_{max}$ )	0-10 bar (0-145 psig)
Accuracy ( $\pm 1 \sigma$ ), 15-90 °C (59-194 °F)	$\pm 2.0 \%$ FS
Accuracy ( $\pm 1 \sigma$ ), 0-120 °C (32-248 °F)	$\pm 2.5 \%$ FS
Response time for sensor electronic	250 ms
Resolution	0.6 mbar (0.009 psig)
<b>Temperature</b>	
Measuring range ( $T_{min}$ to $T_{max}$ )	0-120 °C (32-248 °F)
Accuracy ( $\pm 1 \sigma$ ), 15-90 °C (59-194 °F)	$\pm 0.5$ K
Accuracy ( $\pm 1 \sigma$ ), 0-120 °C (32-248 °F)	$\pm 1$ K
Response time (63.2 % at 50 % FS flow)	250 m s
Resolution	0.006 K
<b>Differential temperature</b>	
Accuracy 15-90 °C (59-194 °F)	0.3 K
Accuracy 0-120 °C (32-248 °F)	0.5 K
<b>System conditions and environment</b>	
Liquid types	Aqueous media compatible with wetted materials Kinematic viscosity $\leq 2$ mm <sup>2</sup> /s (cSt)
System temperature, operation	0-120 °C (32-248 °F)
System temperature, peak	-25 °C (-13 °F), non-freezing 120 °C (248 °F)
Ambient temperature, operation	-25 to +60 °C (-13 to +140 °F)
Ambient temperature, peak	-55 to +90 °C (-67 to +194 °F)
Humidity, relative	0-95 %, non-condensing
Maximum system pressure	30 bar (435 psig)
Burst pressure	40 bar (580 psig)
Maximum system pressure example	Max 16 bar (232 psig) at 100 °C (212 °F) Max 8 bar (116 psig) at 120 °C (248 °F)
Pollution degree	3
Altitude	Max. 2000 m.a.s.l.
Location	If installed outdoors, we recommend that it is done in a protective shed or enclosure to avoid direct sunlight and rain.
<b>Electrical data</b>	
Power supply	5 VDC ( $\pm 5 \%$ ), PELV Grounding of sensor supply required
Digital output signals	Grundfos open data protocol
Analog output signals, only two signals possible (analog variants are upon request)	0.71 - 4.14 V for flow (0.71 V at 2 l/ min, 4.14 V at 18 l/min) 0.5 - 4.1 V for temperature (0.5 V at 0 °C, 4.1 V at 120 °C)
Power consumption	Approximately 75 mW

Load impedance	> 47 k $\Omega$
<b>Materials</b>	
Sensing element	Silicon-based MEMS
Sealing	EPDM O-ring or FKM O-ring
Housing	Composite (PPS, PA66)
Flow pipe	Stainless steel AISI 316 EN 1.4408
Insert	PPA 40 GF
Wetted materials	Corrosion-resistant coating , EPDM or FKM, PPS, PPA 40-GF, 1.4408
<b>Environmental standards</b>	
Enclosure class	IP44, cable connected
Temperature cycling	IEC 68-2-14
Vibration, non-destructive	20-2000 Hz, 10 G, 4 h
Electromagnetic compatibility	EN 61326-1

## MFS QT 4-40 l/min (1.06 - 10.6 gpm)



TM054741

MFS QT 4-40 l/min

### Dimensions

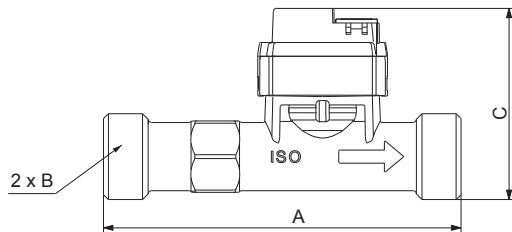

TM054671

Dimensions, MFS QT 4-40 l/min, with threads

	A	B	C
mm	110	ISO 228/1 - G3/4 A	58.8
in	4.33		2.31

### Sensor output signals

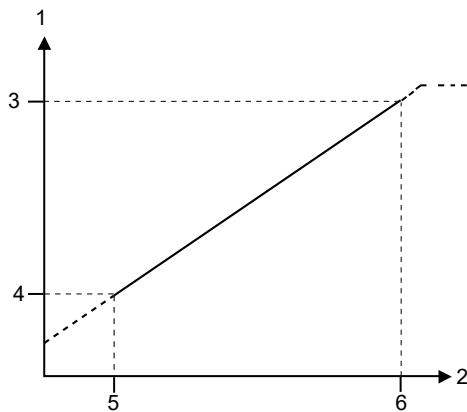

TM082828

Flow response in Analog mode

Pos.	Description
1	Flow output signal
2	Flow
3	3.5 V
4	0.66 V
5	$Q_{min}$
6	$Q_{max}$

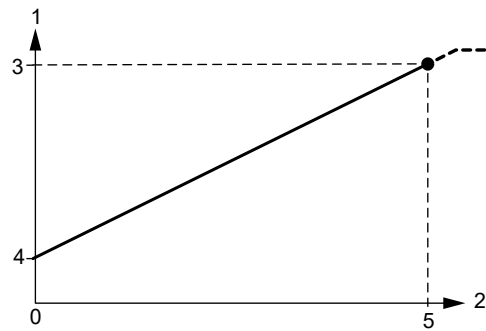

TM063358

Temperature response in Analog mode

Pos.	Description
0	$T_{min}$
1	Temperature output signal
2	Temperature
3	4.1 V
4	0.5 V
5	$T_{max}$



Only two output signals are possible in Analog mode.

As standard:

- Flow
- Temperature.

## Specifications

<b>Flow</b>	
Measuring range ( $Q_{\min}$ to $Q_{\max}$ )	4-40 l/min (1-10.6 gpm)
Accuracy ( $\pm 1 \sigma$ ) in water 0-120 °C (32-248 °F)	$\pm 1 \% \text{ FS}$
Response time (63.2 %)	< 4 s
Resolution	$\frac{Q_{\max}}{16384}$
<b>Pressure</b>	
Measuring range ( $P_{\min}$ to $P_{\max}$ )	0-10 bar (0-145 psig)
Accuracy ( $\pm 1 \sigma$ ), 15-90 °C (59-194 °F)	$\pm 2.0 \% \text{ FS}$
Accuracy ( $\pm 1 \sigma$ ), 0-120 °C (32-248 °F)	$\pm 2.5 \% \text{ FS}$
Response time for sensor electronic	250 ms
Resolution	0.6 mbar (0.009 psig)
<b>Temperature</b>	
Measuring range ( $T_{\min}$ to $T_{\max}$ )	0-120 °C (32-248 °F)
Accuracy ( $\pm 1 \sigma$ ), 15-90 °C (59-194 °F)	$\pm 0.5 \text{ °C}$
Accuracy ( $\pm 1 \sigma$ ), 0-120 °C (32-248 °F)	$\pm 1 \text{ °C}$
Response time (63.2 % at 50 % FS flow)	250 ms
Resolution	0.006 K
<b>Differential temperature</b>	
Accuracy 15-90 °C (59-194 °F)	0.3 K
Accuracy 0-120 °C (32-248 °F)	0.5 K
<b>System conditions and environment</b>	
Liquid types	Aqueous media compatible with wetted materials Kinematic viscosity $\leq 2 \text{ mm}^2/\text{s}$ (cSt)
System temperature, operation	0-120 °C (32-248 °F)
System temperature, peak	-25 °C (-13 °F), non-freezing 120 °C (-248 °F)
Ambient temperature, operation	-25 to +60 °C (-13 to +140 °F)
Ambient temperature, peak	-55 to +90 °C (-67 to +194 °F)
Humidity, relative	0-95 %, non-condensing
Maximum system pressure	30 bar (435 psig)
Burst pressure	40 bar (580 psig)
Maximum system pressure example	Max 16 bar (232 psig) at 100 °C (212 °F) Max 8 bar (116 psig) at 120 °C (248 °F)
Pollution degree	3
Altitude	Max. 2000 m.a.s.l.
Location	If installed outdoors, we recommend that it is done in a protective shed or enclosure to avoid direct sunlight and rain.
<b>Electrical data</b>	
Power supply	5 VDC ( $\pm 5 \%$ ), PELV Grounding of sensor supply required
Digital output signals	Grundfos open data protocol
Analog output signals, only two signals possible (analog variants are upon request)	0.66 - 3.5 V for flow (0.66 V at 4 l/min, 3.5 V at 40 l/min) 0.5 - 4.1 V for temperature (0.5 V at 0 °C, 4.1 V at 120 °C)
Power consumption	Approximately 75 mW

Load impedance	> 47 k $\Omega$
<b>Materials</b>	
Sensing element	Silicon-based MEMS
Sealing	EPDM O-ring or FKM O-ring
Housing	Composite (PPS, PA66)
Flow pipe	Stainless steel AISI 316 EN 1.4408
Insert	PPA 40 GF
Wetted materials	Corrosion-resistant coating , EPDM or FKM, PPS, PPA 40-GF, 1.4408
<b>Environmental standards</b>	
Enclosure class	IP44, cable connected
Temperature cycling	IEC 68-2-14
Vibration, non-destructive	20-2000 Hz, 10 G, 4 h
Electromagnetic compatibility	EN 61326-1

## MFS QT 10-100 l/min (2.6 - 26 gpm)

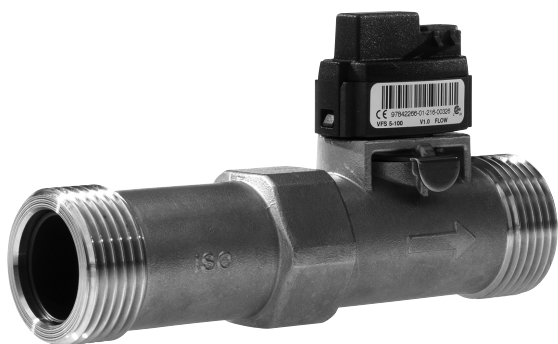

TM054740

MFS QT 10-100 l/min

### Dimensions

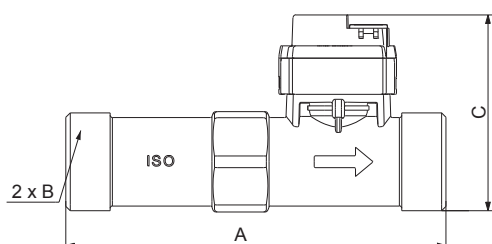

TM054672

Dimensions, MFS QT 10-100 l/min, with threads

	A	B	C
mm	129	ISO 228/1 - G1 A	66.5
in	5.08		2.62

### Sensor output signals

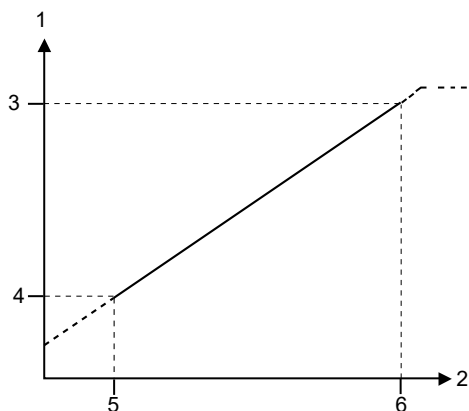

TM082828

Flow response in Analog mode

Pos.	Description
1	Flow output signal
2	Flow
3	3.5 V
4	0.66 V
5	$Q_{\min}$
6	$Q_{\max}$

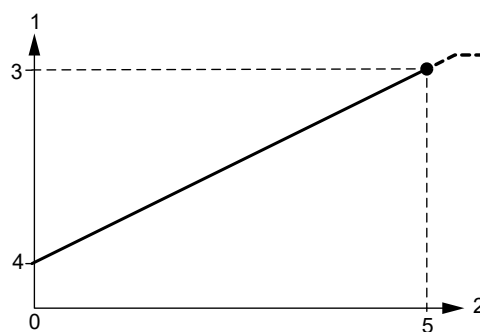

TM063358

Temperature response in Analog mode

Pos.	Description
0	$T_{\min}$
1	Temperature output signal
2	Temperature
3	4.1 V
4	0.5 V
5	$T_{\max}$



Only two output signals are possible in Analog mode.

As standard:

- Flow
- Temperature.

## Specifications

<b>Flow</b>	
Measuring range ( $Q_{min}$ to $Q_{max}$ )	10-100 (2.6 -26 gpm)
Accuracy ( $\pm 1 \sigma$ ) in water 0-120 °C (32-248 °F)	$\pm 1 \% FS$
Response time (63.2 %)	< 4 s
Resolution	$\frac{Q_{max}}{16384}$
<b>Pressure</b>	
Measuring range ( $P_{min}$ to $P_{max}$ )	0-10 bar (0-145 psig)
Accuracy ( $\pm 1 \sigma$ ), 15-90 °C (59-194 °F)	$\pm 2.0 \% FS$
Accuracy ( $\pm 1 \sigma$ ), 0-120 °C (32-248 °F)	$\pm 2.5 \% FS$
Response time for sensor electronic	250 ms
Resolution	0.6 mbar (0.009 psig)
<b>Temperature</b>	
Measuring range ( $T_{min}$ to $T_{max}$ )	0-120 °C (32-248 °F)
Accuracy ( $\pm 1 \sigma$ ), 15-90 °C (59-194 °F)	$\pm 0.5 K$
Accuracy ( $\pm 1 \sigma$ ), 0-120 °C (32-248 °F)	$\pm 1 K$
Response time (63.2 % at 50 % FS flow)	250 ms
Resolution	0.006 K
<b>Differential temperature</b>	
Accuracy 15-90 °C (59-194 °F)	0.3 K
Accuracy 0-120 °C (32-248 °F)	0.5 K
<b>System conditions and environment</b>	
Liquid types	Aqueous media compatible with wetted materials Kinematic viscosity $\leq 2 \text{ mm}^2/\text{s}$ (cSt)
System temperature, operation	0-120 °C (32-248 °F)
System temperature, peak	-25 °C (-13 °F), non-freezing 120 °C (-248 °F)
Ambient temperature, operation	-25 to +60 °C (-13 to +140 °F)
Ambient temperature, peak	-55 to +90 °C (-67 to +194 °F)
Humidity, relative	0-95 %, non-condensing
Maximum system pressure	30 bar (435 psig)
Burst pressure	40 bar (580 psig)
Maximum system pressure example	Max 16 bar (232 psig) at 100 °C (212 °F) Max 8 bar (116 psig) at 120 °C (248 °F)
Pollution degree	3
Altitude	Max. 2000 m.a.s.l.
Location	If installed outdoors, we recommend that it is done in a protective shed or enclosure to avoid direct sunlight and rain.
<b>Electrical data</b>	
Power supply	5 VDC ( $\pm 5 \%$ ), PELV Grounding of sensor supply required
Digital output signals	Grundfos open data protocol
Analog output signals, only two signals possible (analog variants are upon request)	0.66 - 3.5 V for flow (0.66 V at 10 l/ min, 3.5 V at 100 l/min) 0.5 - 4.1 V for temperature (0.5 V at 0 °C, 4.1 V at 120 °C)
Power consumption	Approximately 75 mW

Load impedance	> 47 k $\Omega$
<b>Materials</b>	
Sensing element	Silicon-based MEMS
Sealing	EPDM O-ring or FKM O-ring
Housing	Composite (PPS, PA66)
Flow pipe	Stainless steel AISI 316 EN 1.4408
Insert	PPA 40 GF
Wetted materials	Corrosion-resistant coating , EPDM or FKM, PPS, PPA 40-GF, 1.4408
<b>Environmental standards</b>	
Enclosure class	IP44, cable connected
Temperature cycling	IEC 68-2-14
Vibration, non-destructive	20-2000 Hz, 10 G, 4 h
Electromagnetic compatibility	EN 61326-1

## MFS QT 20-200 l/min (5.3 - 53 gpm)



MFS QT 20-200 l/min

### Dimensions

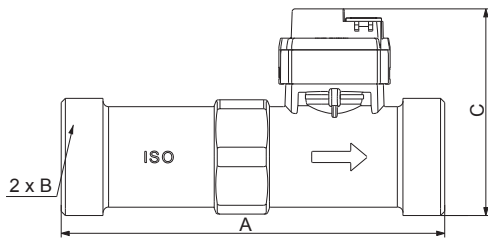

Dimensions, MFS QT 20-200 l/min, with threads

	A	B	C
mm	137.5	ISO 228/1 - G1 1/4 A	74.1
in	5.41		2.92

### Sensor output signals

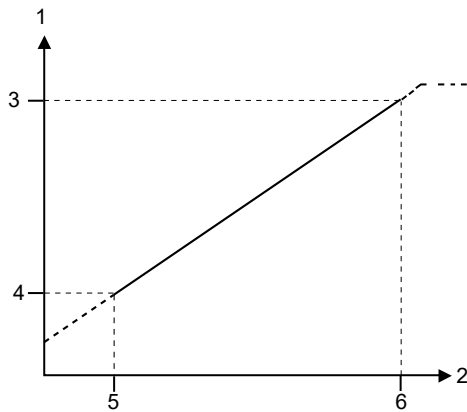

Flow response in Analog mode

Pos.	Description
1	Flow output signal
2	Flow
3	3.5 V
4	0.66 V
5	$Q_{\min}$
6	$Q_{\max}$

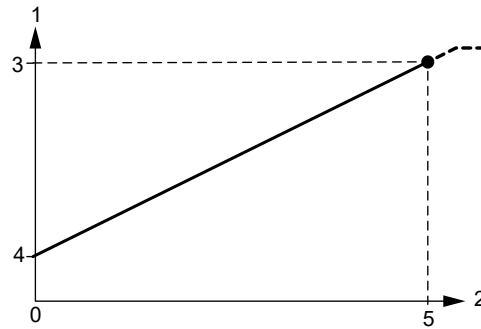

Temperature response in Analog mode

Pos.	Description
0	$T_{\min}$
1	Temperature output signal
2	Temperature
3	4.1 V
4	0.5 V
5	$T_{\max}$



Only two output signals are possible in Analog mode.

As standard:

- Flow
- Temperature.

## Specifications

<b>Flow</b>	
Measuring range ( $Q_{min}$ to $Q_{max}$ )	20-200 l/min (5.3 - 53 gpm)
Accuracy ( $\pm 1 \sigma$ ) in water 0-120 °C (32-248 °F)	$\pm 1 \% FS$
Response time (63.2 %)	< 4 s
Resolution	$\frac{Q_{max}}{16384}$
<b>Pressure</b>	
Measuring range ( $P_{min}$ to $P_{max}$ )	0-10 bar (0-145 psig)
Accuracy ( $\pm 1 \sigma$ ), 15-90 °C (59-194 °F)	$\pm 2.0 \% FS$
Accuracy ( $\pm 1 \sigma$ ), 0-120 °C (32-248 °F)	$\pm 2.5 \% FS$
Response time for sensor electronic	250 ms
Resolution	0.6 mbar (0.009 psig)
<b>Temperature</b>	
Measuring range ( $T_{min}$ to $T_{max}$ )	0-120 °C (32-248 °F)
Accuracy ( $\pm 1 \sigma$ ), 15-90 °C (59-194 °F)	$\pm 0.5 K$
Accuracy ( $\pm 1 \sigma$ ), 0-120 °C (32-248 °F)	$\pm 1 K$
Response time (63.2 % at 50 % FS flow)	250 ms
Resolution	0.006 K
<b>Differential temperature</b>	
Accuracy 15-90 °C (59-194 °F)	0.3 K
Accuracy 0-120 °C (32-248 °F)	0.5 K
<b>System conditions and environment</b>	
Liquid types	Aqueous media compatible with wetted materials Kinematic viscosity $\leq 2 \text{ mm}^2/\text{s}$ (cSt)
System temperature, operation	0-120 °C (32-248 °F)
System temperature, peak	-25 °C (-13 °F), non-freezing 120 °C (-248 °F)
Ambient temperature, operation	-25 to +60 °C (-13 to +140 °F)
Ambient temperature, peak	-55 to +90 °C (-67 to +194 °F)
Humidity, relative	0-95 %, non-condensing
Maximum system pressure	30 bar (435 psig)
Burst pressure	40 bar (580 psig)
Maximum system pressure example	Max 16 bar (232 psig) at 100 °C (212 °F) Max 8 bar (116 psig) at 120 °C (248 °F)
Pollution degree	3
Altitude	Max. 2000 m.a.s.l.
Location	If installed outdoors, we recommend that it is done in a protective shed or enclosure to avoid direct sunlight and rain.
<b>Electrical data</b>	
Power supply	5 VDC ( $\pm 5 \%$ ), PELV Grounding of sensor supply required
Digital output signals	Grundfos open data protocol
Analog output signals, only two signals possible (analog variants are upon request)	0.66 - 3.5 V for flow (0.66 V at 20 l/ min, 3.5 V at 200 l/min) 0.5 - 4.1 V for temperature (0.5 V at 0 °C, 4.1 V at 120 °C)
Power consumption	Approximately 75 mW

Load impedance	> 47 k $\Omega$
<b>Materials</b>	
Sensing element	Silicon-based MEMS
Sealing	EPDM O-ring or FKM O-ring
Housing	Composite (PPS, PA66)
Flow pipe	Stainless steel AISI 316, EN 1.4408
Insert	PPA 40 GF
Wetted materials	Corrosion-resistant coating , EPDM or FKM, PPS, PPA 40-GF, 1.4408
<b>Environmental standards</b>	
Enclosure class	IP44, cable connected
Temperature cycling	IEC 68-2-14
Vibration, non-destructive	20-2000 Hz, 10 G, 4 h
Electromagnetic compatibility	EN 61326-1

## 6. Integrated Temperature sensor Standard, ITS1

### General data

ITS1 sensor

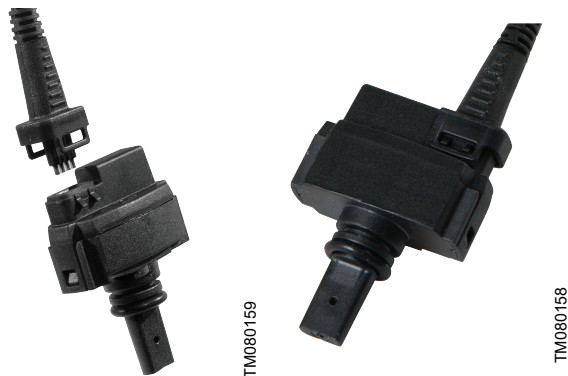

### Technical overview

ITS1 is a temperature sensor from Grundfos Direct Sensors™.

The ITS1 sensor is fully compatible with wet, aqueous media. The sensor is based on MEMS sensing technology in combination with the corrosion-resistant Silicoat® coating technology on the sensor chip.

### Applications

- Pump control
- HVAC systems
- renewable energies such as heat pumps, solar thermals, fresh water and micro-CHP systems
- monitoring and control systems
- water treatment plants
- water utility and distribution systems
- HPC and IT cooling systems.

### Features and benefits

- MEMS technology
- direct contact with the aqueous media resulting in a fast response time
- plug and play for quick setup
- smart system solution with Grundfos pump controls
- compact and robust design
- compatible with aqueous media with a conductivity of 2  $\mu\text{S}/\text{cm}$  or above<sup>5)</sup>
- suitable for a wide temperature range
- suitable for a wide range of application.

### Temperature range

- 0-100 °C (32-212 °F)
- -10 to 120 °C (14-248 °F).

### Approvals (w/EPDM O-rings)

- WRAS

- ACS.

### Compliance

- The versions with EPDM O-rings are compliant with the requirements of the evaluation criteria according to German drinking water regulations (UBA).

### Certificates



C, CSA, US

TM082909

### Markings



CE

TM021695

### Electrical connections

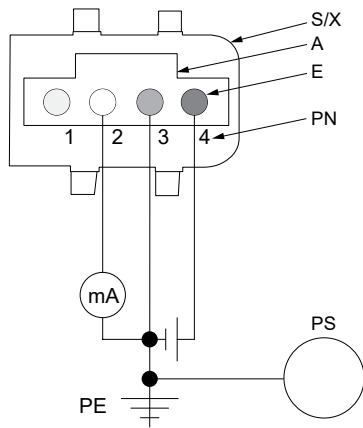

TM075637

#### Electrical connections

Pos.	Description
S/X	Snap-on connector
A	Standard connector
E	Electrical connector pins
PN	Pin No
PS	Pipe system
PE	Protective earth

Pin	Description - Analog signal	Colour
1	Do not connect	Yellow
2	Temperature signal 4-20 mA	White
3	GND, 0 V PELV	Green
4	12-30 V supply voltage	Brown

### Power supply requirements

- VDC 12-30 V PELV.
- The sensor must be separated from hazardous live circuitry by double or reinforced insulation.
- Grounding of sensor supply is required.

### Options



TM066671

TM066670

#### Sensor options

Description
1/2" nipple, stainless steel (316L)

### Directives

Grundfos Direct Sensors™ are in conformity with all applicable EU product legislation:

- EMC Directive (2014/30/EU)
  - Standards used: EN 61326-1:2013 and EN 61326-2-3:2013.
- RoHS Directive (2011/65/EU) and (2015/863/EU)
  - Standard used: EN IEC 63000:2018.

Grundfos Direct Sensors™ are not in the scope of:

- Pressure Equipment Directive (2014/68/EU) according to article 4, paragraph 3.
- Low Voltage Directive (2014/35/EU) because the supply voltage is below 75 VDC.

## ITS1, 0-100 °C (32-212 °F)



ITS sensor

### Dimensions

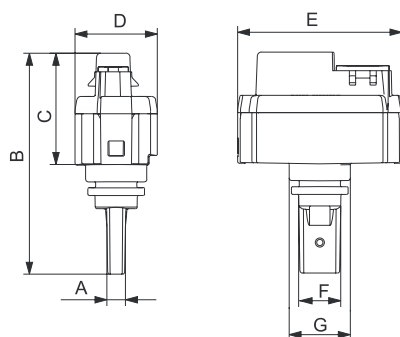

Dimensions, ITS

	A	B	C	D	E	F	G
mm	4.5	53.7	27	20	39.9	10.2	14.8
in	3.23	2.11	1.06	0.79	1.57	0.40	0.58

### Sensor output signals

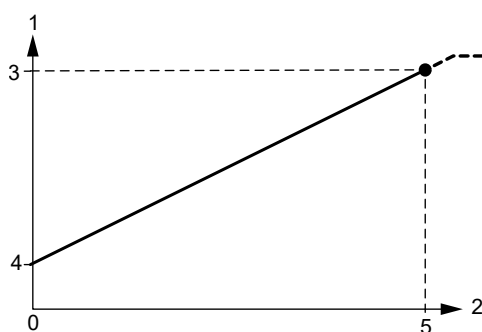

Temperature response in analog mode

Pos.	Description
0	$T_{\min}$
1	Temperature output signal
2	Temperature
3	20 mA
4	4 mA
5	$T_{\max}$

### Specifications

Temperature	
Measuring range ( $T_{\min}$ to $T_{\max}$ )	0-100 °C (32-212 °F)
Accuracy ( $\pm 1 \sigma$ ), in water, 15-90 °C (59-194 °F), 4 bar	$\pm 0.5$ K
Accuracy ( $\pm 1 \sigma$ ), in water, 0-100 °C (32-212 °F), 4 bar	$\pm 1$ K
Response time (63.2 %)	< 0.5 s
Resolution	$0.3 \pm 0.1$ InL K
System conditions and environment	
Liquid types	Aqueous media compatible with wetted materials.
Liquid temperature, operation	0-100 °C (32-212 °F)
Liquid temperature, peak	-10 to +120 °C (14-248 °F), non-freezing
Ambient temperature, operation	-25 to +60 °C (-13 to +140 °F)
Ambient temperature, peak	-55 to +90 °C (-67 to +194 °F)
Humidity, relative	0-95 %, non-condensing
Maximum system pressure	24 bar (348 psi)
Burst pressure	30 bar (435 psi)
Pollution degree	3
Altitude	Max. 2000 m.a.s.l.
Location	If installed outdoors, we recommend that it is done in a protective shed or enclosure to avoid direct sunlight and rain.
Electrical data	
Power supply	12-30 VDC, PELV Grounding of sensor supply required
Analog output signal	4-20 mA
Temperature	(4 mA at 0 °C, 20 mA at 100 °C)
Power consumption at 0 °C (32 °F), $V_{CC} = 24$ V and $R_L = 147 \Omega$	255 mW
Power consumption at 100 °C (212 °F), $V_{CC} = 24$ V and $R_L = 147 \Omega$	655 mW
Load impedance	See fig. Maximum load impedance vs. supply voltage below the table.
Maximum cable length	3 m (9.1 ft)
Materials	
Sensing element	Silicon-based MEMS
Sealing	EPDM O-rings, FKM O-rings or EPDM sealing sleeve with FKM O-rings
Housing	Composite, PPS Corrosion-resistant coating, PPS, EPDM or FKM
Wetted materials	Adapter ISO 7/1 - R1/2" and NPT 1/2", EN 1.4408 (AISI 316)
Environmental standards	
Enclosure class	IP54
Temperature cycling	IEC 68-2-14
Vibration, non-destructive	20-2000 Hz, 10 G, 4 h
Electromagnetic compatibility	EN 61326-1

TM080158

TM054669

TM063358

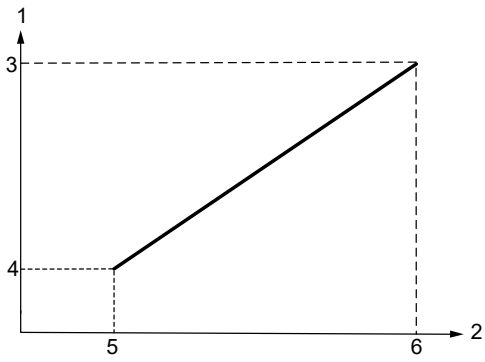

TM082014

Maximum load impedance vs. supply voltage

Pos.	Description
1	Supply Voltage [V]
2	$R_{load}$ [ $\Omega$ ]
3	30 V
4	12 V
5	100 $\Omega$
6	1000 $\Omega$

## ITS1, -10 to +120 °C (14-248 °F)



ITS sensor

### Dimensions

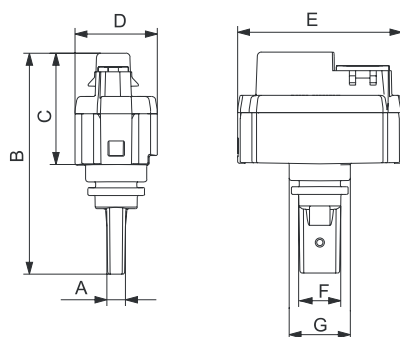

Dimensions, ITS1

	A	B	C	D	E	F	G
mm	4.5	53.7	27	20	39.9	10.2	14.8
in	3.23	2.11	1.06	0.79	1.57	0.40	0.58

### Sensor output signals

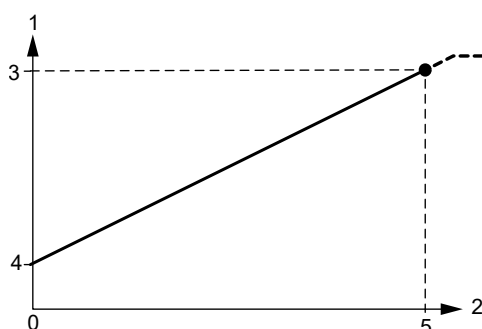

Temperature response in analog mode

Pos.	Description
0	$T_{min}$
1	Temperature output signal
2	Temperature
3	20 mA
4	4 mA
5	$T_{max}$

### Specifications

Temperature	
Measuring range ( $T_{min}$ to $T_{max}$ )	-10 to +120 °C (14-248 °F)
Accuracy ( $\pm 1 \sigma$ ), in water 15-90 °C (59-194 °F), 4 bar	$\pm 0.5$ K
Accuracy ( $\pm 1 \sigma$ ), in water -10 to +120 °C (14-248 °F), 4 bar	$\pm 1.5$ K
Response time (63.2 %)	< 0.5 s
Resolution	0.3 $\pm$ 0.1 InL K
System conditions and environment	
Liquid types	Aqueous media compatible with wetted materials.
Liquid temperature, operation	0-100 °C (32-212 °F)
Liquid temperature, peak	-10 to +120 °C (14-248 °F), non-freezing
Ambient temperature, operation	-25 to +60 °C (-13 to +140 °F)
Ambient temperature, peak	-55 to +90 °C (-67 to +194 °F)
Humidity, relative	0-95 %, non-condensing
Maximum system pressure	24 bar (348 psi)
Burst pressure	30 bar (435 psi)
Pollution degree	3
Altitude	Max. 2000 m.a.s.l.
Location	If installed outdoors, we recommend that it is done in a protective shed or enclosure to avoid direct sunlight and rain.
Electrical data	
Power supply	12-30 VDC, PELV Grounding of sensor supply required
Analog output signal	4-20 mA
Temperature	(4 mA at -10 °C, 20 mA at 120 °C)
Power consumption at -10 °C (14 °F), $V_{CC} = 24$ V and $R_L = 147 \Omega$	255 mW
Power consumption at 120 °C (248 °F), $V_{CC} = 24$ V and $R_L = 147 \Omega$	655 mW
Load impedance	See the figure below.
Maximum cable length	3 m (9.1 ft)
Materials	
Sensing element	Silicon-based MEMS
Sealing	EPDM O-rings, FKM O-rings or EPDM sealing sleeve with FKM O-rings
Housing	Composite, PPS Corrosion-resistant coating, PPS, EPDM or FKM
Wetted materials	Adapter ISO 7/1 - R1/2" and NPT 1/2", EN 1.4408 (AISI 316)
Environmental standards	
Enclosure class	IP44
Temperature cycling	IEC 68-2-14
Vibration, non-destructive	20-2000 Hz, 10 G, 4 h
Electromagnetic compatibility	EN 61326-1

TM080158

TM054669

TM063358

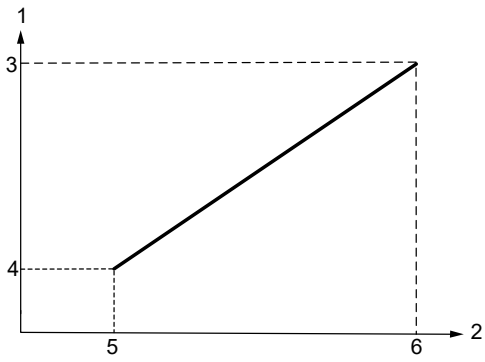

TM082014

Maximum load impedance vs. supply voltage

Pos.	Description
1	Supply Voltage [V]
2	$R_{load}$ [ $\Omega$ ]
3	30 V
4	12 V
5	100 $\Omega$
6	1000 $\Omega$

## 7. Product range

### VFI transmitters

#### Scope of delivery

- Flow pipe with transmitter
- flanges, only for flange versions
- fittings and union nuts for threaded versions
- 5 m (16.4 ft) cable with free cable end
- quick guide.

Complete product	Flow range	Flange size	O-ring		Connection type			Outside usage <sup>6)</sup>
			EPDM	FKM	Cast iron flange	Stainless steel flange	Thread	
VFI/-0.3-6m/1/C/M5.00-X/EG6/SG/30F/AC-1			•		•			•
VFI/-0.3-6m/1/C/M5.00-X/VG6/SG/30F/AC-1				•	•			•
VFI/-0.3-6m/1/C/M5.00-X/EG6/SS/30F/AC-1	0.3 - 6 m <sup>3</sup> /h	DN 25/32	•			•		•
VFI/-0.3-6m/1/C/M5.00-X/VG6/SS/30F/AC-1	1.32 - 26.4 gpm	ANSI 1 1/4"		•		•		•
VFI/-0.3-6m/1/C/M5.00-X/EG6/SS/07P/AC-1			•				•	•
VFI/-0.3-6m/1/C/M5.00-X/VG6/SS/07P/AC-1				•			•	•
VFI/-0.6-12m/1/C/M5.00-X/EG6/SG/30F/AC-1			•		•			•
VFI/-0.6-12m/1/C/M5.00-X/VG6/SG/30F/AC-1				•	•			•
VFI/-0.6-12m/1/C/M5.00-X/EG6/SS/30F/AC-1	0.6 - 12 m <sup>3</sup> /h	DN 25/32	•			•		•
VFI/-0.6-12m/1/C/M5.00-X/VG6/SS/30F/AC-1	2.64 - 52.8 gpm	ANSI 1 1/4"		•		•		•
VFI/-0.6-12m/1/C/M5.00-X/EG6/SS/07P/AC-1			•				•	•
VFI/-0.6-12m/1/C/M5.00-X/VG6/SS/07P/AC-1				•			•	•
VFI/-1.3-25m/1/C/M5.00-X/EG6/SG/30F/AC-1			•		•			•
VFI/-1.3-25m/1/C/M5.00-X/VG6/SG/30F/AC-1				•	•			•
VFI/-1.3-25m/1/C/M5.00-X/EG6/SS/30F/AC-1	1.3 - 25 m <sup>3</sup> /h	DN 25/32	•			•		•
VFI/-1.3-25m/1/C/M5.00-X/VG6/SS/30F/AC-1	5.72 - 110.1 gpm	ANSI 1 1/4"		•		•		•
VFI/-1.3-25m/1/C/M5.00-X/EG6/SS/09P/AC-1			•				•	•
VFI/-1.3-25m/1/C/M5.00-X/VG6/SS/09P/AC-1				•			•	•
VFI/-2-40m/1/C/M5.00-X/EG6/SG/31F/AC-1			•		•			•
VFI/-2-40m/1/C/M5.00-X/VG6/SG/31F/AC-1	2-40 m <sup>3</sup> /h	DN 40		•	•			•
VFI/-2-40m/1/C/M5.00-X/EG6/SS/31F/AC-1	8.81 - 176.1 gpm	ANSI 1 1/2"	•			•		•
VFI/-2-40m/1/C/M5.00-X/VG6/SS/31F/AC-1				•		•		•
VFI/-3.2-64m/1/C/M5.00-X/EG6/SG/32F/AC-1			•		•			•
VFI/-3.2-64m/1/C/M5.00-X/VG6/SG/32F/AC-1	3.2 - 64 m <sup>3</sup> /h	DN 50		•	•			•
VFI/-3.2-64m/1/C/M5.00-X/EG6/SS/32F/AC-1	14.09 - 281.8 gpm	ANSI 2"	•			•		•
VFI/-3.2-64m/1/C/M5.00-X/VG6/SS/32F/AC-1				•		•		•
VFI/5.2-104m/1/C/M5.00-X/EG6/SG/33F/AC-1			•		•			•
VFI/5.2-104m/1/C/M5.00-X/VG6/SG/33F/AC-1	5.2 - 104 m <sup>3</sup> /h	DN 65		•	•			•
VFI/5.2-104m/1/C/M5.00-X/EG6/SS/33F/AC-1	22.89 - 457.9 gpm	ANSI 2 1/2"	•			•		•
VFI/5.2-104m/1/C/M5.00-X/VG6/SS/33F/AC-1				•		•		•
VFI/-8-160m/1/C/M5.00-X/EG6/SG/35F/AC-1			•		•			•
VFI/-8-160m/1/C/M5.00-X/VG6/SG/35F/AC-1	8-160 m <sup>3</sup> /h	DN 80		•	•			•
VFI/-8-160m/1/C/M5.00-X/EG6/SS/35F/AC-1	35.22 - 704.5 gpm	ANSI 3"	•			•		•
VFI/-8-160m/1/C/M5.00-X/VG6/SS/35F/AC-1				•		•		•
VFI/-12-240m/1/C/M5.00-X/EG6/SG/42F/AC-1			•		•			•
VFI/-12-240m/1/C/M5.00-X/VG6/SG/42F/AC-1	12-240 m <sup>3</sup> /h	DN 100		•	•			•
VFI/-12-240m/1/C/M5.00-X/EG6/SS/42F/AC-1	52.83 - 1057 gpm	ANSI 4"	•			•		•
VFI/-12-240m/1/C/M5.00-X/VG6/SS/42F/AC-1				•		•		•

## VFS and VFS QT sensors

## Scope of delivery

- Flow pipe with sensor
- composite flow pipe with brass adapter (only VFS)
- stainless steel flow pipe (only VFS QT)
- quick guide.

Complete product	Flow range	O-ring		Flow pipe		Connection type	
		EPDM	FKM	Composite	Stainless steel	Brass adapter	Stainless steel
VFS/---1-20l/5/Q/S-----/EG4/CB/03P/SW-1	1.3 - 20 l/min	•		•		ISO 228-G1/2 A	
VFS/---1-20l/5/Q/S-----/VG4/CB/03P/SW-1				•	•	ISO 228-G1/2 A	
VFS/---2-40l/5/Q/S-----/EG4/CB/04P/SW-1	2-40 l/min	•		•		ISO 228-G3/4 A	
VFS/---2-40l/5/Q/S-----/VG4/CB/04P/SW-1				•	•	ISO 228-G3/4 A	
VFS/---5-100l/5/Q/S-----/EG4/CB/04B/SW-1	5-100 l/min	•		•		ISO 7/1 R 3/4	
VFS/---5-100l/5/Q/S-----/VG4/CB/04B/SW-1				•	•	ISO 7/1 R 3/4	
VFS/-10-200l/5/Q/S-----/EG4/CB/05B/SW-1	10-200 l/min	•		•		ISO 7/1 R 1	
VFS/-10-200l/5/Q/S-----/VG4/CB/05B/SW-1				•	•	ISO 7/1 R 1	
VFS/-20-400l/5/Q/S-----/EG4/CB/07B/SD-1	20-400 l/min	•		•		ISO 7/1 R 1 1/4	
VFS/-20-400l/5/Q/S-----/VG4/CB/07B/SD-1				•	•	ISO 7/1 R 1 1/4	
VFS/---1-18l/5/4/S-----/EG4/Q-/04P/SW-1	1-18 l/min	•			•	ISO 228/1-G3/4 A	
VFS/---1-18l/5/4/S-----/VG4/Q-/04P/SW-1				•		•	ISO 228/1-G3/4 A
VFS/---2-40l/5/Q/S-----/EG4/Q-/04P/SW-1	2-40 l/min	•			•	ISO 228/1-G3/4 A	
VFS/---2-40l/5/Q/S-----/VG4/Q-/04P/SW-1				•		•	ISO 228/1-G3/4 A
VFS/---5-100l/5/Q/S-----/EG4/Q-/05P/SW-1	5-100 l/min	•			•	ISO 228/1-G1 A	
VFS/---5-100l/5/Q/S-----/VG4/Q-/05P/SW-1				•		•	ISO 228/1-G1 A
VFS/-10-200l/5/Q/S-----/EG4/Q-/07P/SW-1	10-200 l/min	•			•	ISO 228/1-G1 1/4 A	
VFS/-10-200l/5/Q/S-----/VG4/Q-/07P/SW-1				•		•	ISO 228/1-G1 1/4 A

## 8. Accessories

### Sensor interface, converter unit

The SI Converter sensor interface from Grundfos Direct Sensors™ is an external power supply, signal amplifier and signal converter for Grundfos sensors, standard variants (MFS, VFS, RPS and DPS).

SI Converter has built-in precision resistors enabling the sensor to give 4-20 mA, 1-5 V and 2-10 V output signals. SI Converter is designed for applications where sensors from the standard product range are used. The sensor interface delivers a 4-20 mA input signal to external controllers.



TM044862

Sensor interface, SI Converter

#### Specifications

- Voltage range: 115-230 VAC  $\pm$  10 % or 24 VDC
- frequency: 50-60 Hz
- power consumption: Maximum 2.5 W
- ambient temperature: -20 to +50 °C (-4 to +122 °F)
- enclosure class: IP20.

#### Part

Sensor interface, SI Converter, IP20

### M12 cable

The 4-wire screened cable with M12 connector in the sensor end and open end in the equipment end is available as an accessory. Use the cable for the industrial sensor series such as RPI, DPI 2 and VFI.



M12\_CABLE

Description	Length
Cable, industry M2.00-X	2 m (6.6 ft)
Cable, industry M5.00-X	5 m (16.4 ft)

### Snap-on cable

Cable with snap-on connection in sensor end and different variants in the equipment end, such as open end, ferrules and various types of connectors.

Use the cable for the standard sensor series such as MFS, VFS, RPS, DPS and ITS.

The cable is available in various lengths, mainly 1.2 m and 2.9 m.



TM082830

Description	Length [mm]
Ferrules, 1.2 m	1200
Ferrules, 2.9 m	2900

# 9. Appendix

## Pressure drop curves

### VFI sensor

Selection of flow sensor to minimise pressure drop at 1 cSt

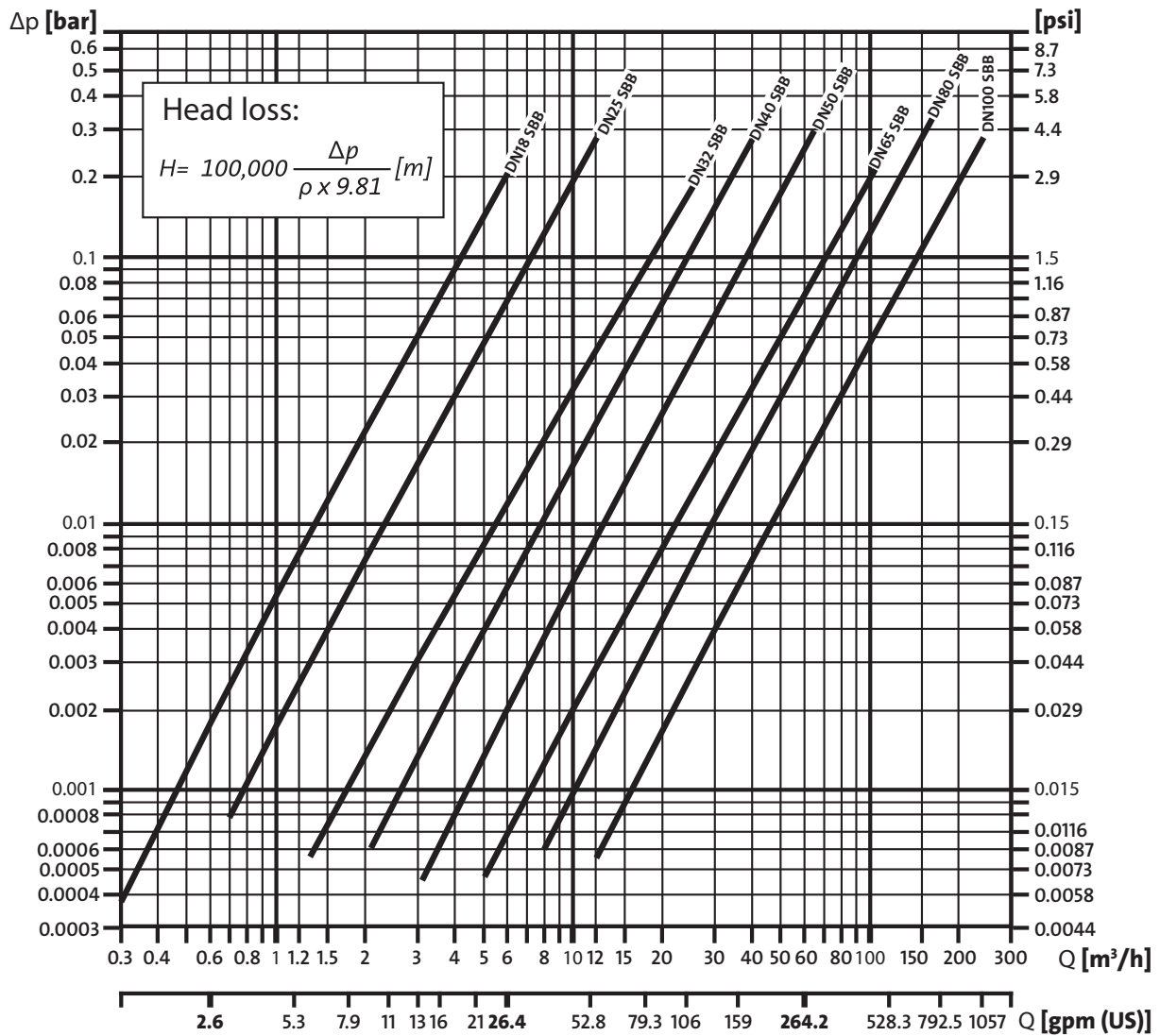

TM066536

### VFS sensor

Selection of flow sensor to minimise pressure drop at 1 cSt

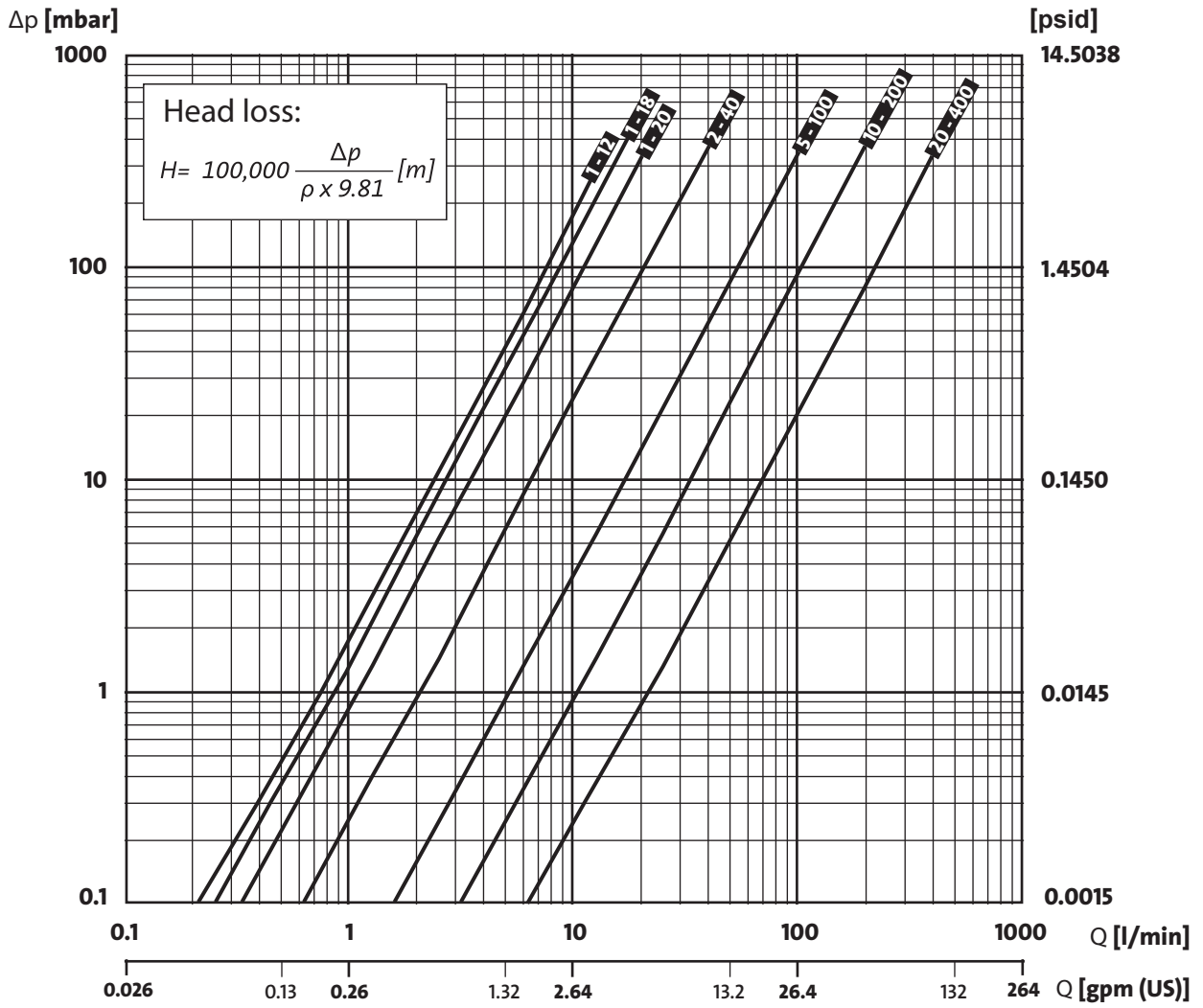

TM066537

### Installation of VFI sensors

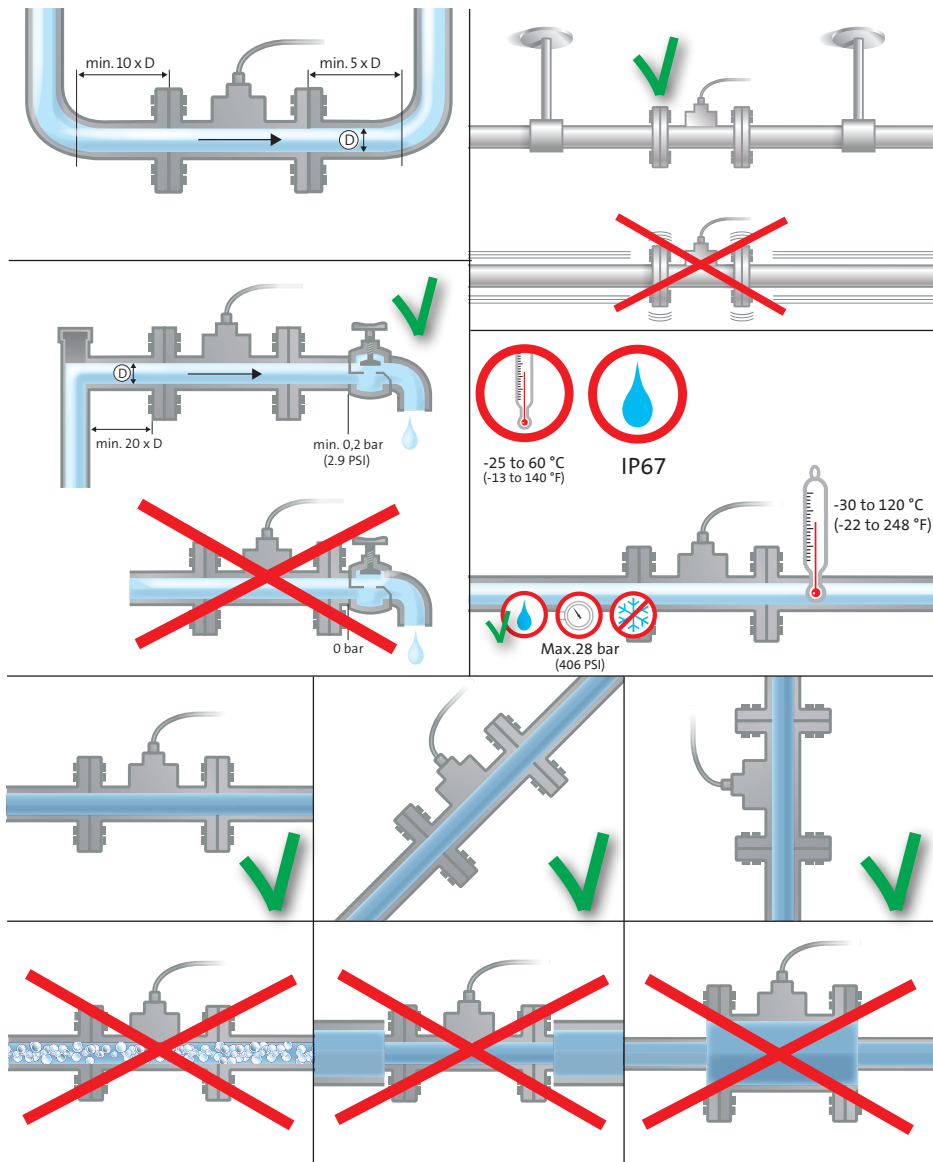

TM052306

Intended use for pressurised systems

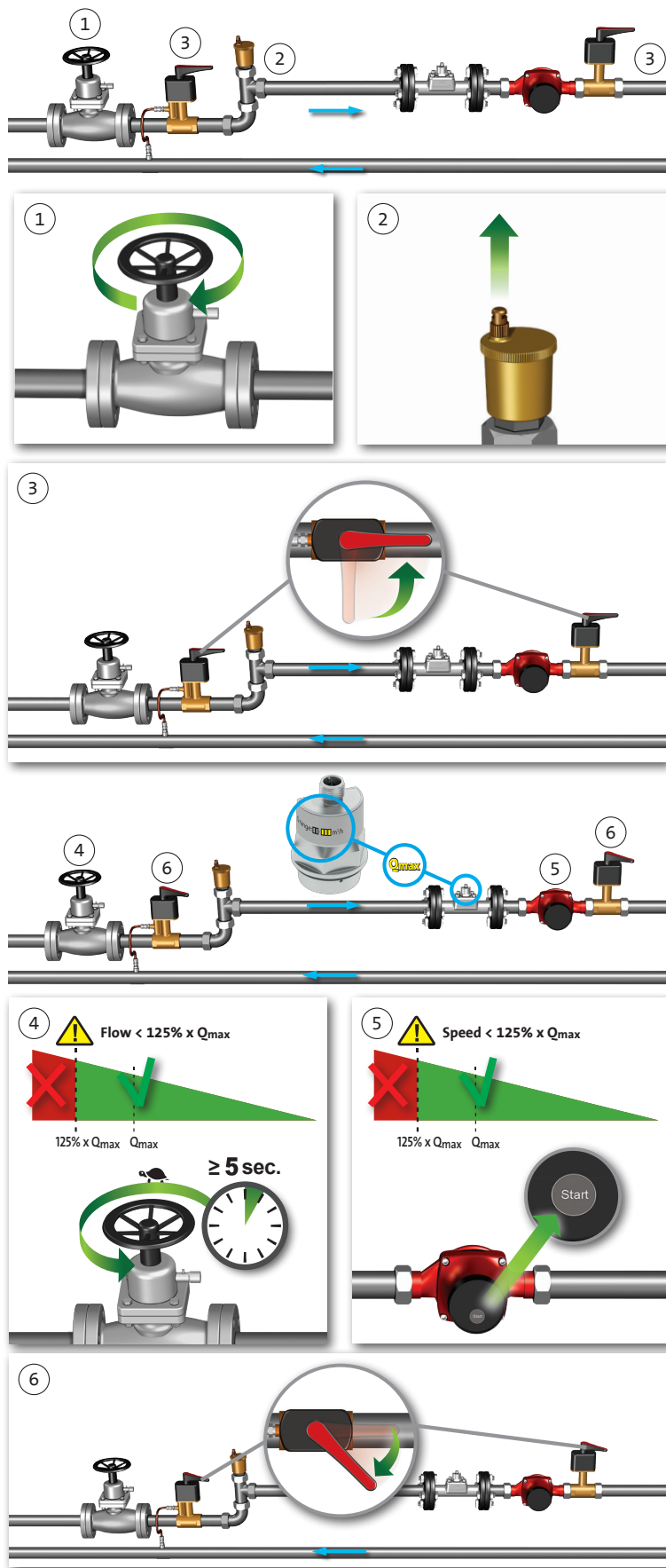

TM071865

## 10. Grundfos Product Center

Online search and sizing tool to help you make the right choice.

From the international view, you can select your specific country to view the product range available to you.

International view: <http://product-selection.grundfos.com>

### All the information you need in one place

Performance curves, technical specifications, pictures, dimensional drawings, motor curves, wiring diagrams, spare parts, service kits, 3D drawings, documents, system parts. The Product Center displays any recent and saved items - including complete projects - right on the main page.

### Downloads

On the product pages, you can download installation and operating instructions, data booklets, service instructions, etc., in PDF format.

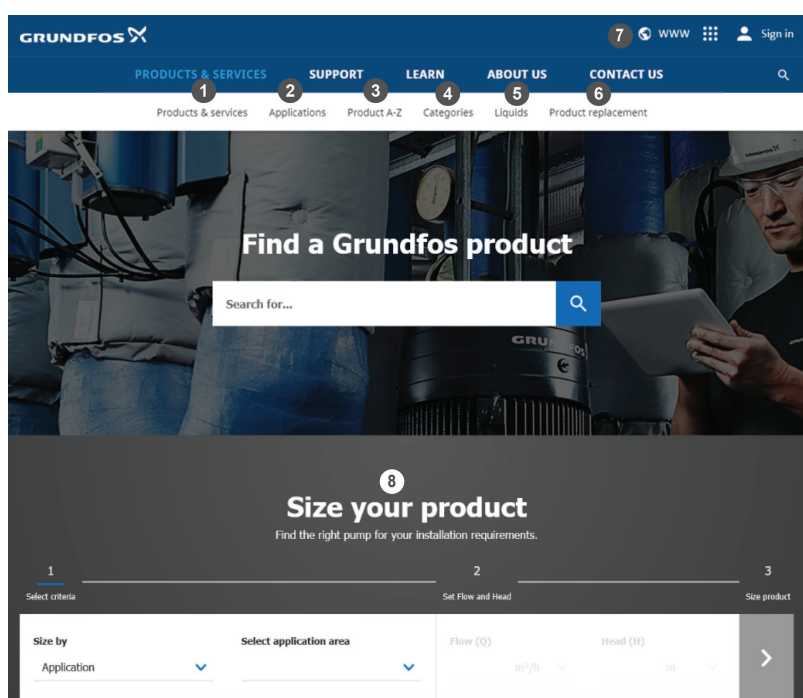
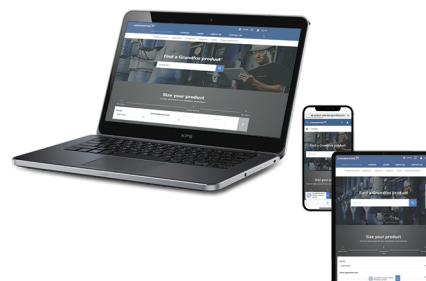

When you select your country, you will see the menus below. Note that some menus may not be available depending on the country.

Example: <https://product-selection.grundfos.com/uk>

Pos.	Description
1	<b>Products &amp; services</b> enables you to find products and documents by typing a product number or name into the search field.
2	<b>Applications</b> enables you to choose an application to see how Grundfos can help you design and optimise your system.
3	<b>Products A-Z</b> enables you to look through a list of all the Grundfos products.
4	<b>Categories</b> enables you to look for a product category.
5	<b>Liquids</b> enables you to find pumps designed for aggressive, flammable or other special liquids.
6	<b>Product replacement</b> enables you to find a suitable replacement.
7	<b>WWW</b> enables you to select the country, which changes the language, the available product range and the structure of the website.
8	<b>Sizing</b> enables you to size a product based on your application and operating conditions.

97790189 06.2025

ECM: 1424524

**GRUNDFOS Holding A/S**  
Poul Due Jensens Vej 7  
DK-8850 Bjerringbro  
Tel: +45 87 50 14 00  
[www.grundfos.com](http://www.grundfos.com)

**GRUNDFOS** 