

Wilo-Control BE-WP

Ed. 8.22

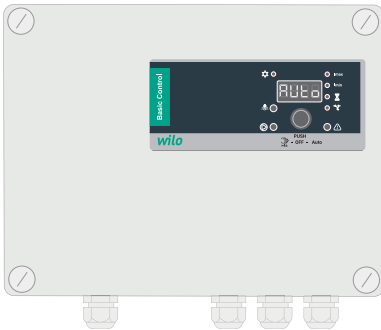

ENGLISH (EN) User manual

Multi-control and multi-protection panel for 1 submersible or surface pump

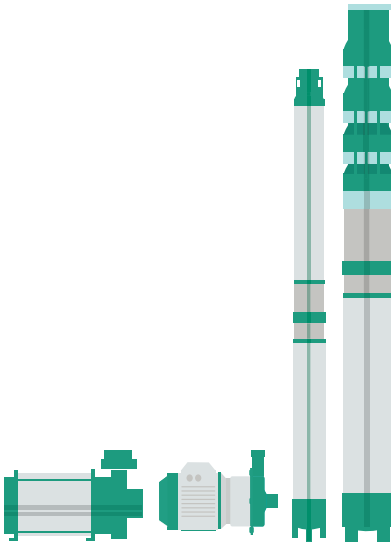

CONTENT

ENGLISH (EN)

1. FRONT DISPLAY SETTINGS.....	4
2. DISPLAY MESSAGES.....	4
3. LED SIGNALLING.....	5
4. INTERNAL LAYOUT.....	6
5. SETTING-UP (WALL MOUNTING).....	7
6. POWER CONNECTIONS.....	8
7. MOTOR CONNECTIONS.....	9
8. LEVEL CONTROL INPUTS.....	10
9. EXTERNAL CONTROL.....	12
10. AUXILIARY AND ALARM OUTPUT.....	13
11. IMAX, IMIN, RESTART TIME AND INHIBITION TIME SETTING.....	14
12. REPEAT AUTOMATIC CALIBRATION.....	15
13. OPERATION.....	16
14. ALARMS.....	17
15. DATALOGGER.....	17
16. RESET TO FACTORY SETTINGS.....	18
17. ADDITIONAL SETTINGS.....	18
18. ADVANCED OPTIONS.....	19
19. TECHNICAL CHARACTERISTICS.....	20

SAFETY WARNING

CAUTION! Before making any adjustments, it is essential to connect the motor to the equipment to avoid unintentional tripping of the underload protection (minimum load 0.5A). We recommend to follow all procedure and safety instructions approved in your area operating with equipment connected to the electrical power supply. Important safety information is detailed hereafter. For safe installation and operation of this equipment, be sure to read and understand all cautions and warnings. **⚠ WARNING:** Before installing, operating, servicing, or testing this equipment, read and understand the contents of this manual. Improper operation, handling, or maintenance could result in death, serious personal injury, and equipment damage. **⚠ WARNING:** This equipment is not designed to safeguard human lives. Follow all locally approved safety procedures and practices installing or operating this equipment. Failure doing so could result in death, serious personal injury, and equipment damage. **⚠ WARNING:** Dangerous voltages. Contact with electrical current will cause serious personal injury or death. Follow all locally approved safety procedures when working near high voltage lines and equipment **⚠ WARNING:** This equipment requires periodic inspection and maintenance to ensure proper operation. If not properly maintained, it may fail to operate properly. Incorrect operation could cause damage to the equipment and possibly result in personal injury. **⚠ WARNING:** All connections must be made by a qualified person in charge. There is a risk of electric shock if this warning is not heeded. **⚠ WARNING:** Additional protection of the pump motor may be added when necessary in the installation. **⚠ WARNING:** If the equipment is used or modified outside the manufacturer's specifications, Wilo disclaims all liability due to improper use. The interior of the equipment should only be handled by personnel of our technical service.

WARNING



- Before making any adjustments, it is essential to connect the motor to the equipment to avoid unintentional tripping of the underload protection (minimum load 0.6A).
- The equipment is *ready to use* factory configured, once the Power, Motor and External Control (optional) connections have been made. See datasheet attached to the manual.

1. FRONT DISPLAY SETTINGS

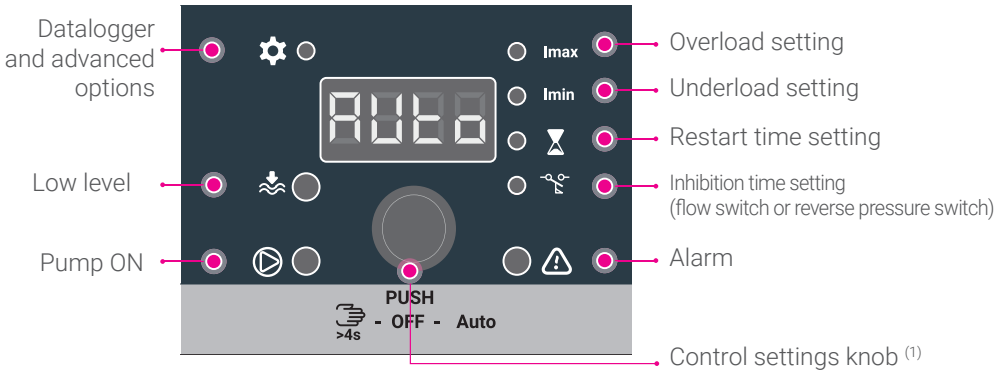

(1) The rotative pushbutton is used to configure the various setting parameters (selection/modification/confirmation), to select the HAND-OFF-AUTO operating mode, to reset a motor failure or to interrupt a timer in progress (see pages 15 to 17)

















2. DISPLAY MESSAGES

OFF	Pump stopped.
Auto	Automatic mode activated.
93A	Pump power consumption (A).
3h	Time in hours.
42'	Time in minutes.
35"	Time in seconds (flow switch inhibition).
HIGH Freq	Excessive frequency of starts.
Err. PHAS	Phase failure or abnormal current absorbed by the pump (+40% of the current threshold set in Imax).
Hand	Manual reset after a water shortage (without reset time set).
SEt	Enter the "Datalogger and advanced options" menu.
dAtA	Datalogger
F.rES	Reset the unit to factory defaults (Factory Reset).
End	Exit "Datalogger and advanced options".















3. LED SIGNALLING

Depending on the operation being performed or the warning that the equipment is indicating, the LEDs will light up in different colors and in a fixed or intermittent manner. While scrolling through the various parameters, pay attention to the meaning shown in the "During adjustment" column. If the equipment is in operation and the control panel is not being used, look at the "In operation" column.

• During adjustment

 I_{max}	Parameter selection "Overload setting"
 I_{max}	Parameter modification "Overload setting"
 I_{min}	Parameter selection "Underload setting"
 I_{min}	Parameter modification "Underload setting"
 	Parameter selection "Restart time setting"
 	Parameter modification "Restart time setting"
 	Parameter selection "Inhibition time setting"
 	Parameter modification "Inhibition time setting"
 	Parameter selection "Datalogger and advanced option setting"
 	Parameter modification "Datalogger and advanced option setting"

• In operation

 I_{max}	Overload detected
 I_{max}	Overload trip
 I_{min}	Underload detected
 I_{min}	Underload trip
 	Restart time running
 	Inhibition time running
 	Low level detected
 	Pump running
 	Main alarm activated

 Fixed	 Flashing
---	--

4. INTERNAL LAYOUT

BE-WP-1x16A-MT4-DOL

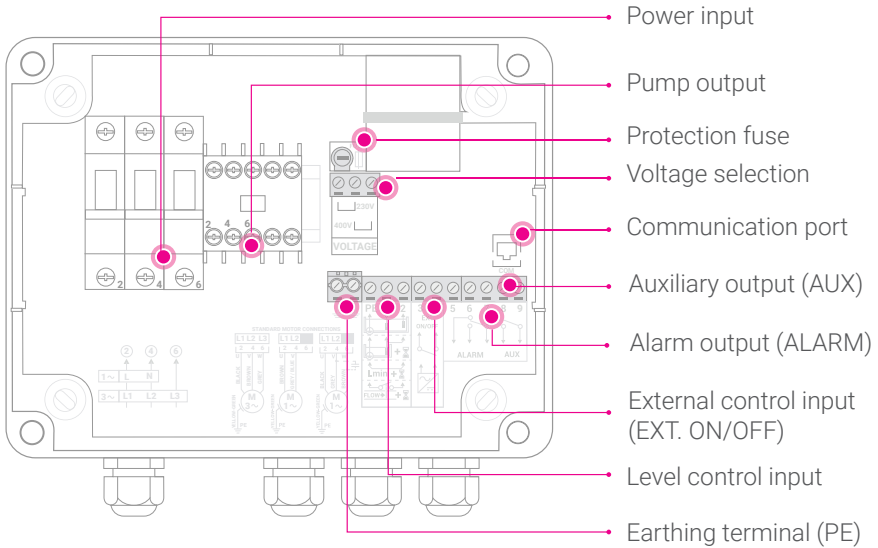

BE-WP-1x25A-MT4-DOL

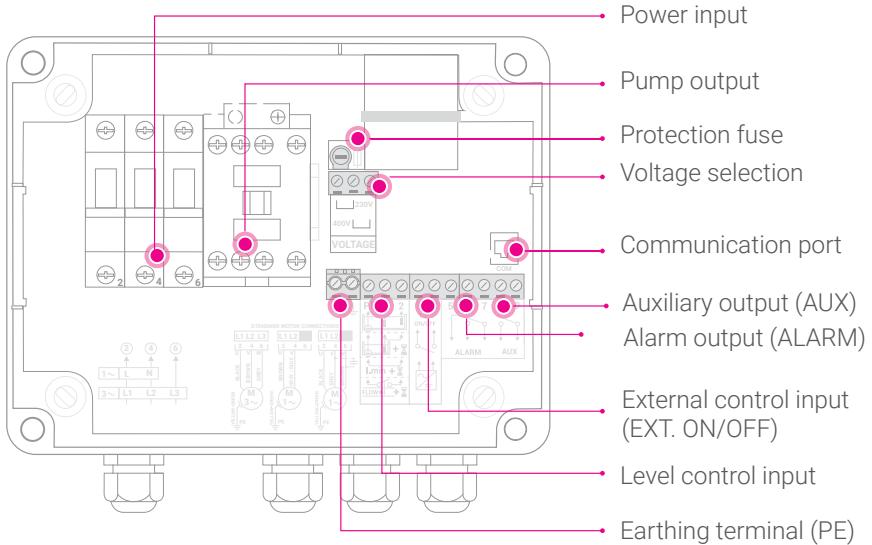

5. SETTING-UP (WALL MOUNTING)

Clamping brackets mounting

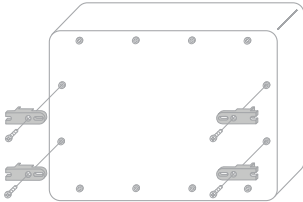

- 1 Place the fixing brackets in the anchor points established for this purpose.
- 2 Drill holes in the wall using the location where you have placed the fixing brackets.
- 3 Insert the screws to anchor the equipment by using the fixing brackets.

ENGLISH (EN)

Direct wall mounting

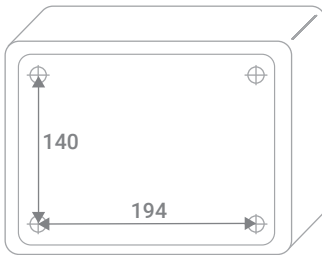

Drill the wall at the indicated dimensions (in mm) and screw the equipment directly to the wall.

A full-size template is enclosed with the drilling indications for easier fastening.

6. POWER CONNECTIONS

- Voltage selection.

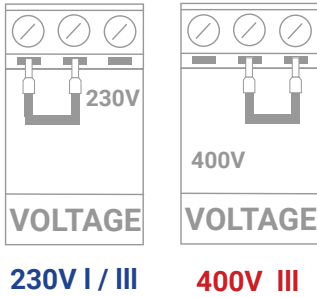

Place the jumper cable to select the supply voltage.

- Single-phase power input (L/N, 230 VAC).

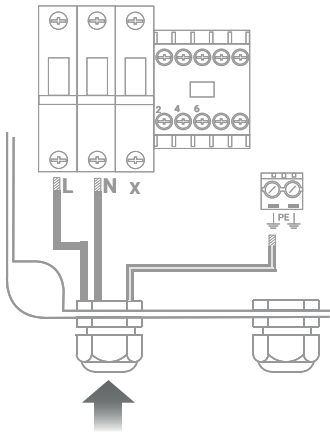

- Three-phase power input (L1/L2/L3, 230/400 VAC).

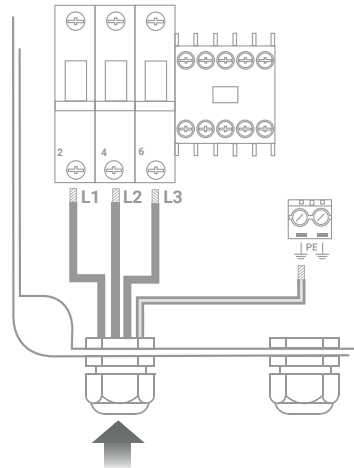

7. MOTOR CONNECTIONS

- Three-phase pump output.

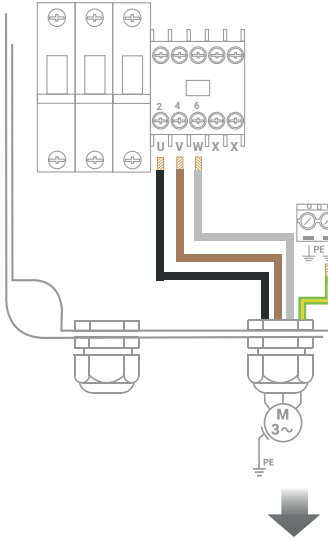

- Single-phase pump output with integrated start capacitor.

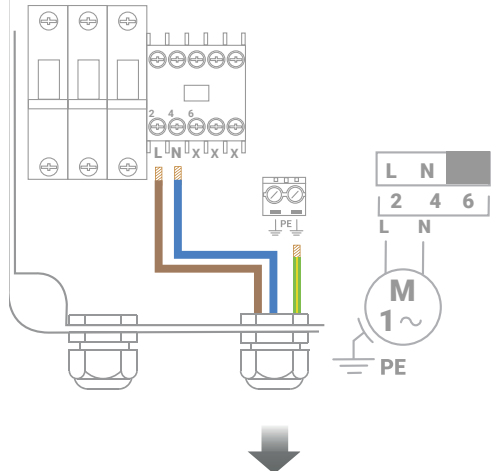

- Single-phase pump output with separate start capacitor.

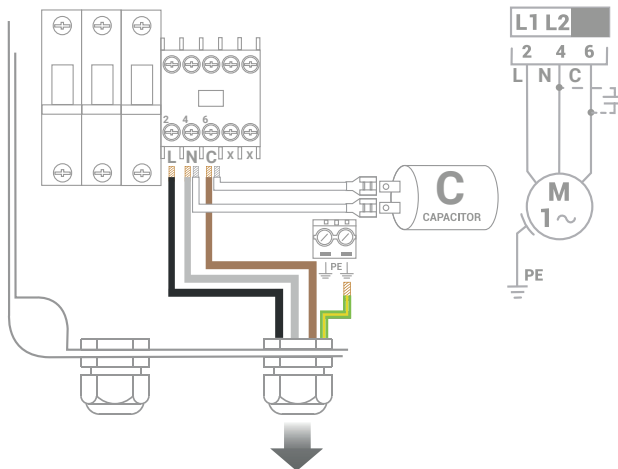

8. LEVEL CONTROL INPUTS

- Additional level probe for isolated tank

If the tank is made of insulating material, an additional probe must be added to the bottom connected to PE.

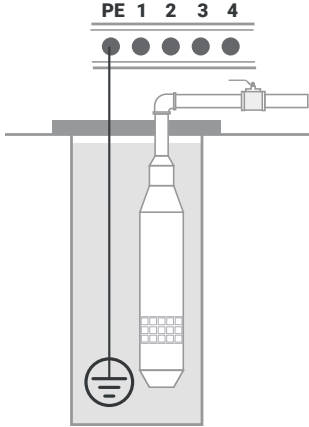

- Not used

When the level control is not used, PE and 2 terminals must be bypassed

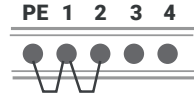

- 2 Probes

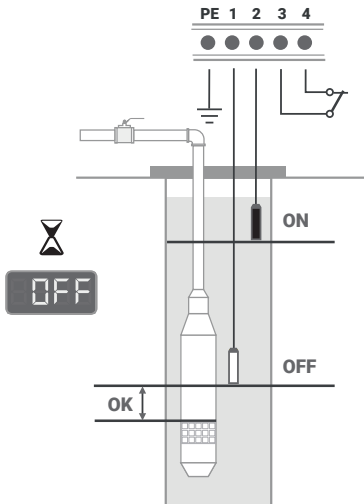

- 1 Level probe + Restart time

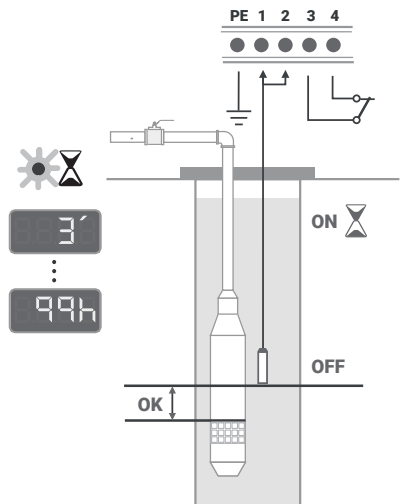

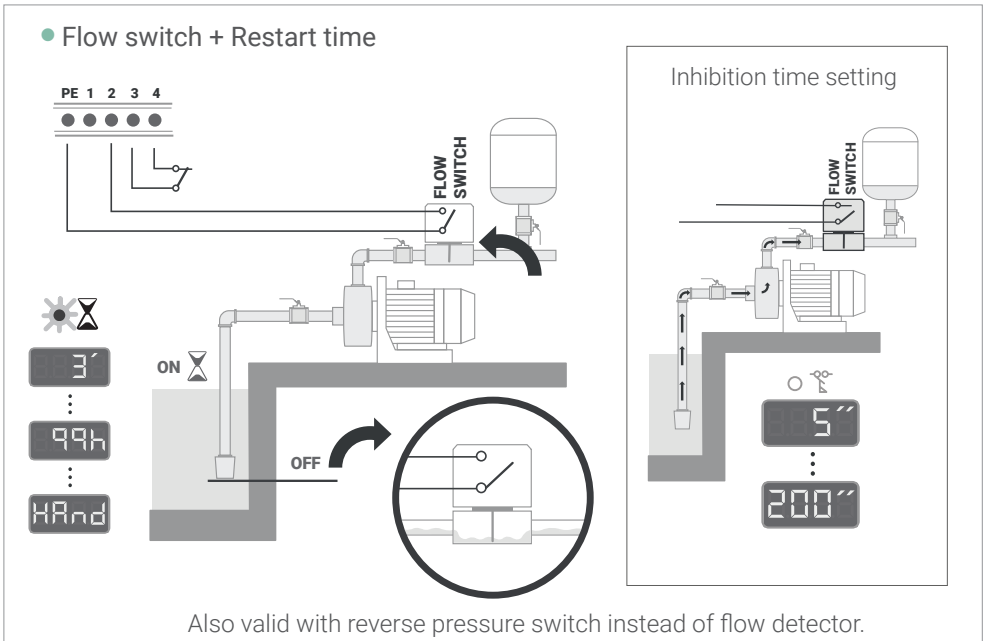
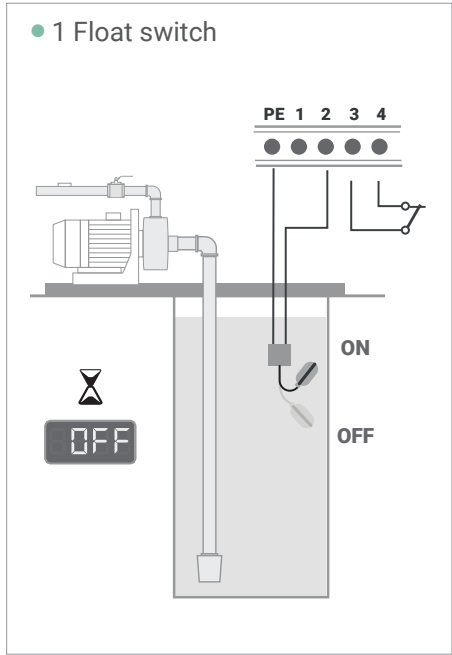
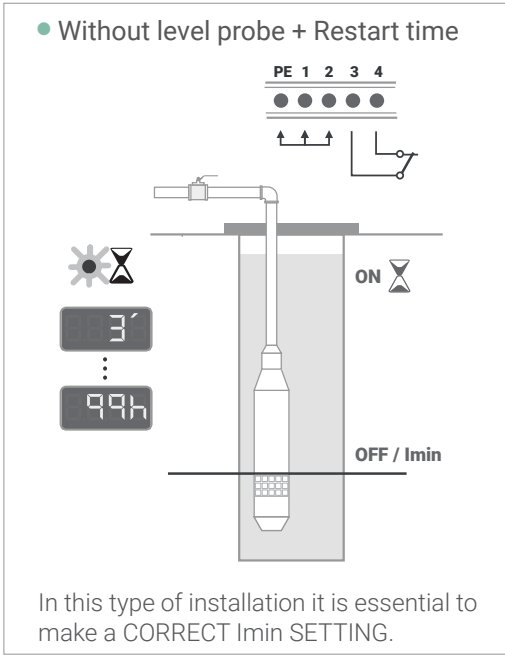

9. EXTERNAL CONTROL

- Not used

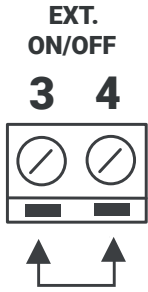

- Pressure switch

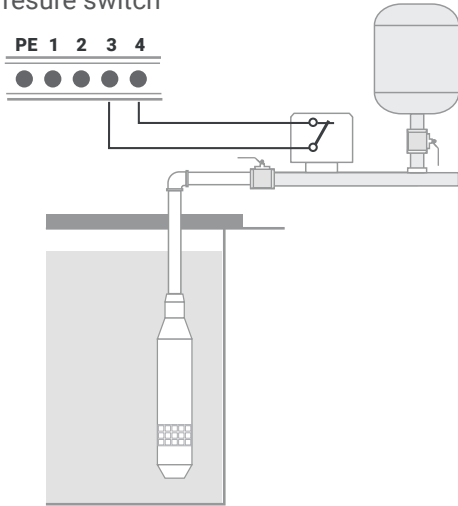

- External power supply direct to terminals, from 6 to 400V AC/DC.

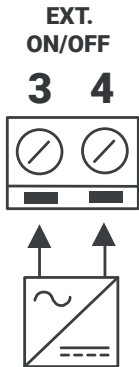

For example, 24V watering programmer or 230V Presscontrol.

- Float switch

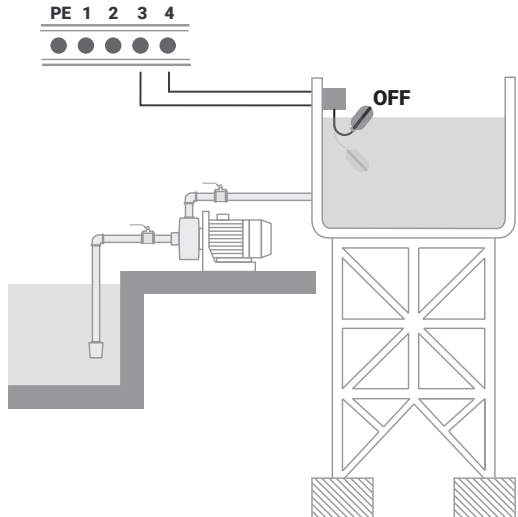

10. AUXILIARY AND ALARM OUTPUT

Alarm output

Closes in case of:

- Overload alarm.
- Underload alarm.
- Excessive start frequency alarm.
- Phase loss alarm (three-phase pumps).
- Abnormal current absorbed by the pump (+40% of the current threshold set to I_{max}).
- Power supply failure.

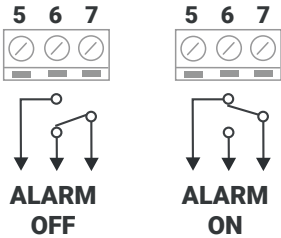

Auxiliary output.

Closes in case of low level.

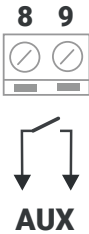

Application example: How to use AUX output to refill a tank in case of low level.

The diagram shows a circuit for an application example. It features a 230 VAC input connected to a Transformer. The secondary of the transformer is 24VAC, which is connected to a Filling solenoid valve. The AUX output terminal block is connected to the 230 VAC line, with a switch that can connect to either the 230 VAC line or the 24VAC line.

11. IMAX, IMIN, RESTART TIME AND INHIBITION TIME SETTING

Automatic adjustment

The equipment adjusts itself with the 1st start-up. After the first 60 seconds, the equipment registers the maximum and minimum current consumption of the pump. Then, the controller sets the maximum current value a **15% above the I_{max}** recorded current and the minimum current value a **25% below the I_{min}** recorded current. Make sure the pump is primed and the discharge line is full during the calibration process. If this is not the case, do not hesitate to repeat the process by selecting "CAL" in the I_{max} parameter.

In any case, the current absorbed by the pump at full load (nominal consumption) must always be between the values of the motor overload (I_{max}) and motor underload (I_{min})

current thresholds.

Maximum current allowed for the pump



I_{max}

Current at which the overload protection trips (adjustable from 0.6 to 29 Amps depending on model). Overload trip time is 7 seconds. This fault activates the alarm output.

Minimum current allowed for the pump



I_{min}

Current at which the overload protection trips (disconnectable "OFF" or adjustable from 0.5 to 28,8 Amps depending on model). The underload trip time is 4 seconds except during 1st start-up, which extends this time up to 20 seconds to allow correct priming of the pump.

Underload (minimum current or I_{min}) setting process to operate without level probes

- 1 Close the impulsion valve.
- 2 Run the pump in manual mode (see chapter 13).
- 3 Note the showed current consumption on the display.
- 4 Stop the pump.
- 5 Adjust the "I_{min}" parameter at least 0.1A above the rated current before readed (see next page).
- 6 Start the pump again and verify that the underload is detected and the pump stops.
- 7 Open the impulsion valve.
- 8 Select the required reset time. 
- 9 Reset the Vigilec Compact pressing the rotary knob.

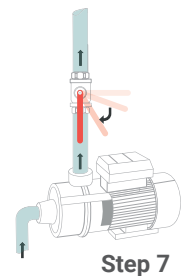
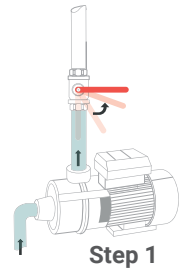

Manual setting of I_{max}, I_{min}, restart time or inhibition time

1. Select the parameter to be modified.
2. Press and set new parameter value.
3. Press for more than 2 seconds to save.

Example parameter change I_{max}:

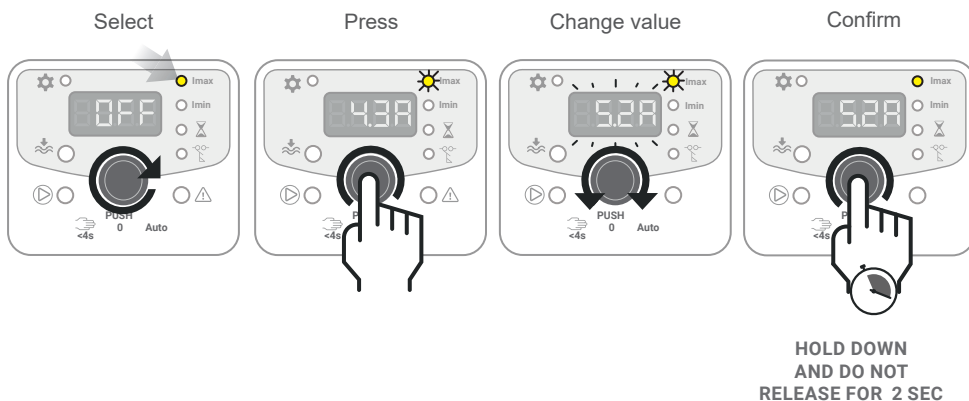

12. REPEAT AUTOMATIC CALIBRATION

The equipment is self-adjusted with the first start-up. If you wish to perform a new automatic calibration, select CAL in I_{max} parameter:

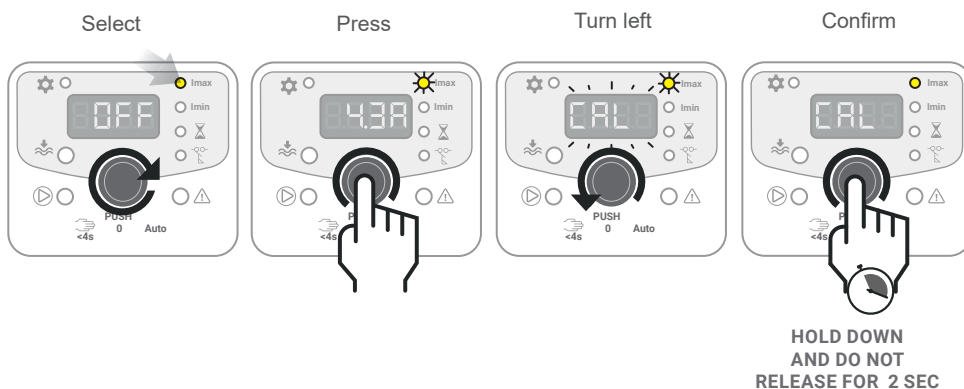

13. OPERATION

How to switch from OFF to Auto

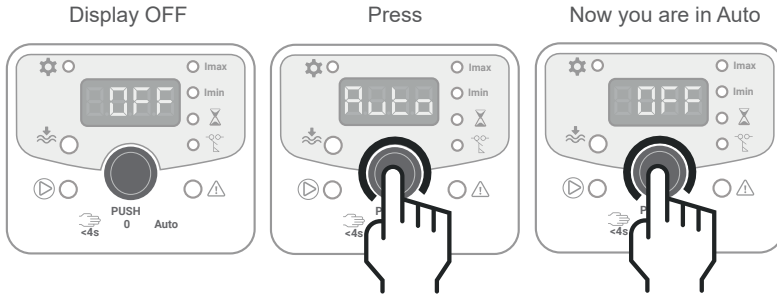

Manual mode

It will only stay in manual mode as long as we press and hold.

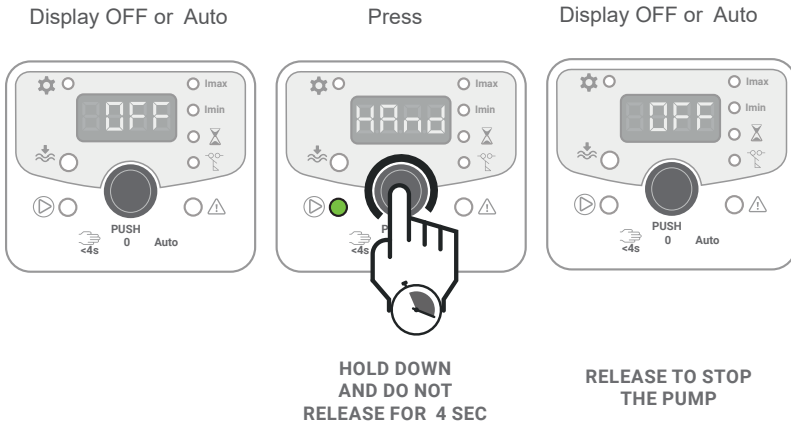

14. ALARMS

Alarm message

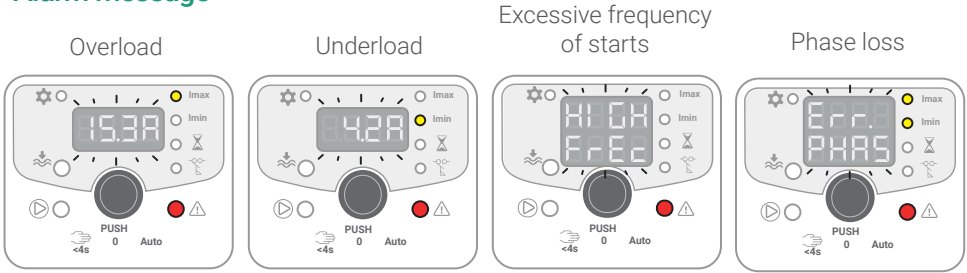

Alarm reset

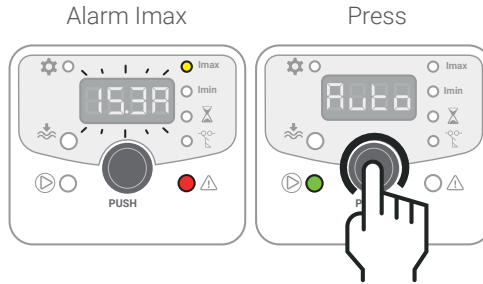

ENGLISH (EN)

15. DATALOGGER

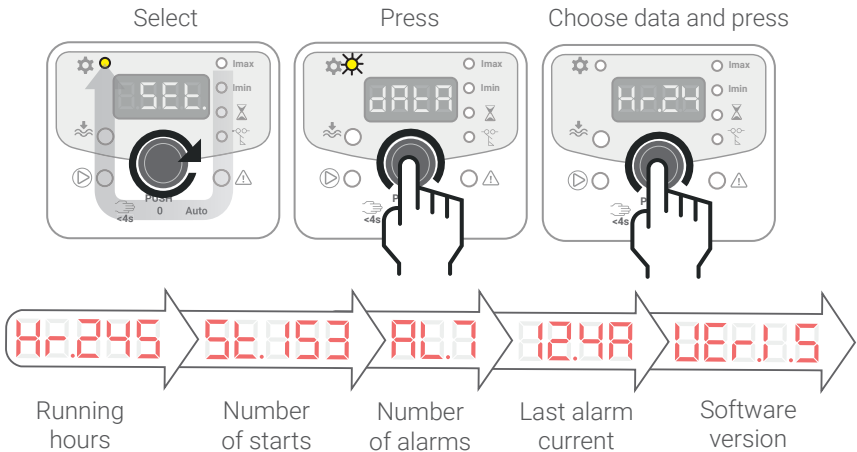

16. RESET TO FACTORY SETTINGS

After this operation the equipment returns to the factory default settings.

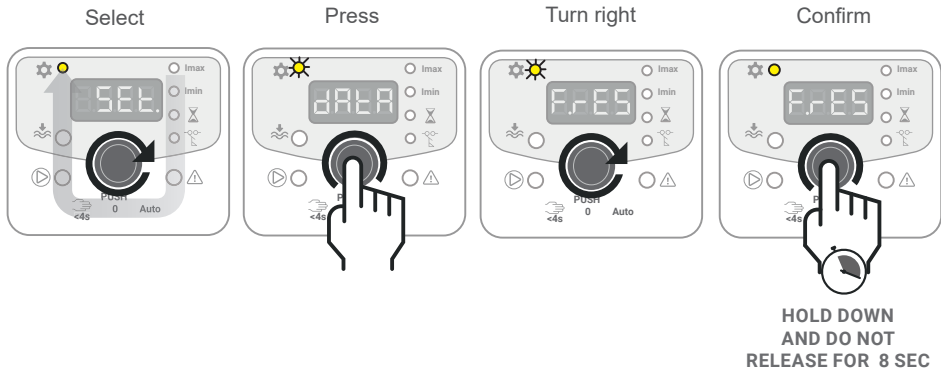

Note: The counters of hours, starts, alarms and current of the last alarm will not be deleted.

17. ADDITIONAL PROTECTIONS

Excessive start frequency detection

After a start the pump needs at least 120 seconds to assume the initial effort. If a new start appears before the end of this time the temperature of the pump increase.

In the event of more that 30 successive starts preventing the pump to cool down, the excessive start frequency alarm is activated. The pump stops, the alarm output is activated and the display shows the message **[FrEc- HIGH]**.

Anti-lock system. Jammed impeller preventive system

Every 23 hours Vigilec Compact will run the pump for 1 second avoiding blockage of the pump motor. Intended to avoid possible failures after long inactivity periods.

Phase failure protection (three phase pumps)

If in a three-phase installation one of the phases is interrupted or missing, in the power supply to the equipment or in the output to the pump, a phase failure will occur. The unit detects the problem and displays the fault **[PHA]-[Err]**. In order for this fault to be detected, the underload setting (Imin) must not be set in "OFF".

Overvoltage protection

If the power supply exceeds the nominal value by more than 30%, the equipment stops its operation. When the voltage returns to the correct value, operation will be restored.

18. ADVANCED SETTINGS

The equipment have a number of advanced settings that are disabled by default (EASY/PRO mode in SET parameter).

Level deactivated/activated (LEV ON / LEV OFF)

Allows to enable or disable the level detection by means of probes.

Pumping direction selection (OUT / IN)

Allows to select the operating mode of the probes, being able to select emptying mode (well) or filling mode (tank).

Excessive frequency of starts (OFF / ON)

Allows to enable or disable the excessive frequency of starts protection.

Anti-blocking protection (OFF / ON)

Allows to enable or disable the pump anti-blocking protection.

Manual latched/unlatched mode(HAND)



Allows the activation of the manual latched mode, whereby the button needs not be held down while in manual mode. Allows to return to the unlatched manual mode.

To learn more about these settings and how to activate them, please contact us.

19. TECHNICAL CHARACTERISTICS

	BE-WP-1x16A-MT4-DOL	BE-WP-1x25A-MT4-DOL
Power supply	230/400 VAC (selectable)	230/400 VAC (selectable)
Admissible voltage variation	+/-20% (>30%: Auto Power Off)	+/-20% (>30%: Auto Power Off)
Max. current	16 Amp AC3	25 Amp AC3
Protections	Overload, Underload, Phase-loss, Excessive frequency of starts, Anti-blocking.	Overload, Underload, Phase-loss, Excessive frequency of starts, Anti-blocking.
Display	LED 4 digits	LED 4 digits
Signaling	Pump ON, Alarm, Low level, Max. current (I.max), Min. current (I.min), Restart time and flow switch inhibition.	Pump ON, Alarm, Low level, Max. current (I.max), Min. current (I.min), Restart time and flow switch inhibition.
Overload setting (I.max)	0.6 - 20.0 A	0.6 - 29.0 A
Underload setting (I.min)	OFF - 0.5 - 19.8 A	OFF - 0.5 - 28.8 A
Restart time setting	from 3 minutes to 99 hours or manual	from 3 minutes to 99 hours or manual
Inhibition time setting	5-200 seconds (flow switch)	5-200 seconds (flow switch)
Overload trip time	7 seconds	7 seconds
Underload trip time	4 seconds (20 sec. at startup)	4 seconds (20 sec. at startup)
Capacitor maximum capacity	-	-
Probes operating voltage	24 VAC	24 VAC
Probes sensitivity	10 K \pm 15% Ω	10 K \pm 15% Ω
External input ON/OFF	Voltage or contact from 6 to 400 VAC/VDC	Voltage or contact from 6 to 400 VAC/VDC
Alarm and auxiliary output contact	AC1: 2 A/250 VAC AC11: 1 A/230 VAC	AC1: 2 A/250 VAC AC11: 1 A/230 VAC
Recorded information	Running hours, number of starts, number of alarms and last alarm current.	Running hours, number of starts, number of alarms and last alarm current.
Control terminal blocks	4 mm ²	4 mm ²
Mounting method	Mounting brackets or direct to wall	Mounting brackets or direct to wall
Cable glands (Power/Motor/Control)	1xM20/1xM20/1xM20+2xM16	1xM25/1xM25/1xM20+2xM16
Working temperature	-10 +55°C	-10 +55°C
Protection degree	IP56	IP56
Size	225 x 255 x 110 mm	225 x 255 x 180 mm
Net weight	1,8 Kg	2,2 Kg
Software version	V.1.5	V.1.5

Factory Reset

Imax	CAL - 0,6 ... 20.0 A	CAL
Imin	OFF - 0.5 ... 19.8 A	0.5A
	OFF - 3' ... 99h - HAnd	15'
	OFF - 5" ... 200"	OFF

	SEt	dAtA	Hr.00
			St.00
			AL.0
			0.0A
			VEr1.5
			EASY
		F.rES	
		End	



Lined writing area consisting of multiple horizontal lines for text entry.

wilo



Cod. 50022177. 8.22