

## Wilo-Stratos MAXO/-D/-Z



Wilo-Smart Connect 

en User manual



Stratos MAXO  
<https://qr.wilo.com/171>

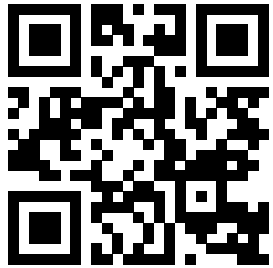

Stratos MAXO-D  
<https://qr.wilo.com/172>

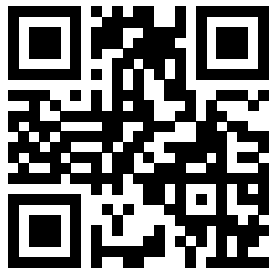

Stratos MAXO-Z  
<https://qr.wilo.com/173>

## Table of contents

<b>1 General</b> .....	<b>5</b>	7.2 Country/language/units.....	78
1.1 About these instructions .....	5	7.3 Bluetooth On/Off.....	79
1.2 Identification of safety instructions .....	5	7.4 Key lock on .....	79
1.3 Personnel qualifications.....	6	7.5 Device information.....	80
<b>2 Pump operation</b> .....	<b>6</b>	7.6 Pump kick .....	81
2.1 Description of operating elements .....	6	<b>8 Help</b> .....	<b>81</b>
2.2 Settings on pump.....	7	8.1 Help system .....	81
2.3 Initial settings menu.....	8	8.2 Service contact .....	82
2.4 Home screen.....	9	8.3 Diagnostics help .....	82
2.5 Main menu .....	12	<b>9 Error messages</b> .....	<b>83</b>
2.6 Sub-menu.....	12	<b>10 Warning messages</b> .....	<b>85</b>
2.7 "Settings" sub-menu .....	12	<b>11 Configuration warnings</b> .....	<b>89</b>
2.8 Settings dialogues .....	13	<b>12 Software update</b> .....	<b>92</b>
2.9 Status area and status displays.....	14	12.1 Installing the Wilo-Smart connect function.....	92
<b>3 Setting the control functions</b> .....	<b>16</b>	12.2 Starting the Wilo-Smart connect function.....	92
3.1 Basic control functions .....	16	12.3 Preparing a Bluetooth connection .....	93
3.2 Additional control functions .....	20	12.4 Establishing a Bluetooth connection.....	93
<b>4 Settings and configuration</b> .....	<b>23</b>	12.5 Dashboard of the connected pump .....	93
4.1 Settings assistant .....	24	12.6 Updating pump software .....	93
4.2 Pre-defined applications in the setting assistant.....	33	12.7 Update firmware .....	93
4.3 Settings menu – Set auto control.....	36	12.8 Software update for connected twin-head pumps.....	94
4.4 Adjustment – Manual operation .....	38	<b>13 Accessories</b> .....	<b>94</b>
4.5 Setting up Multi-Flow Adaptation .....	39	13.1 ClimaForm cold water insulation shell.....	94
4.6 Configuration storage/data storage .....	45	13.2 PT1000 AA (immersion temperature sensor) .....	94
4.7 Heating/cooling quantity measurement .....	45	13.3 PT1000 B (pipe surface contact sensor) .....	95
4.8 Setback operation.....	47	13.4 Immersion sleeves .....	95
4.9 Restore and reset.....	47	13.5 CIF module.....	95
4.10 Operating data/statistics.....	51	13.6 Angle plug.....	96
4.11 Pump venting .....	52	13.7 Fluid temperature sensor (Version R7).....	96
4.12 Pump kick.....	52	<b>14 FAQs</b> .....	<b>96</b>
4.13 Ramp times .....	53	14.1 Delivery state .....	96
<b>5 Double pump operation</b> .....	<b>53</b>	14.2 CIF module/BMS.....	96
5.1 Function .....	53	14.3 Display .....	96
5.2 Dual-pump operation settings .....	53	14.4 Twin-head pump .....	97
5.3 Display for twin-head pump operation .....	55	14.5 Installation position.....	97
5.4 Behaviour EXT. OFF for twin-head pumps.....	57	14.6 Battery.....	97
<b>6 Communication interfaces: Setting and function</b> .....	<b>58</b>	14.7 Spare parts.....	97
6.1 Application and function of SSM relay.....	58	14.8 External interfaces.....	97
6.2 Application and function of SBM relay .....	59	14.9 Error message.....	98
6.3 Setting individual fault signal (ESM) for twin-head pumps .....	60	14.10 Heating & cooling .....	98
6.4 Setting individual run signal (EBM) for twin-head pumps .....	61	14.11 Measured values .....	98
6.5 SSM/SBM relay forced control.....	61	14.12 Control modes.....	98
6.6 Application and function of the digital control inputs DI1 and DI2 .....	61	14.13 Stratos MAXO plug .....	98
6.7 Application and function of the analogue inputs AI1 and AI2 .....	63	14.14 Domestic hot water circulation .....	99
6.8 Application and function of the Wilo Net interface .....	76	14.15 Factory setting .....	99
6.9 Application and function of CIF module.....	77	14.16 Additional control functions .....	99
<b>7 Device settings</b> .....	<b>77</b>	14.17 Generator operation.....	99
7.1 Display brightness .....	78	14.18 Disabling Bluetooth.....	99
		14.19 Key lock.....	99
		14.20 Temperature sensor .....	100
		<b>15 Pump settings with typical applications</b> .....	<b>101</b>

15.1	Setting control mode “ $\Delta p-c$ ” using the underfloor heating type of heating system as an application example .....	101
15.2	Setting “Volume flow $Q-c$ ” in the basic control modes .....	101
15.3	Setting “External interfaces 0-10V” .....	101
15.4	Setting “control mode $T-c$ ” including configuration of a PT1000 temperature sensor .....	102
15.5	Setting “control mode $\Delta T-c$ ” in the heating application – including configuration of a PT1000 temperature sensor .....	102
15.6	Setting “control mode $\Delta T-c$ ” in the cooling application – including configuration of a PT1000 temperature sensor .....	103
15.7	Setting “Temperature correction” .....	104
15.8	Setting “Heat quantity measurement” .....	104
15.9	Setting automatic “switching between heating and cooling” .....	105
15.10	Setting two single pumps in dual-pump operation.....	105
15.11	Setting “Detection of thermal disinfection” .....	106

## 1 General

### 1.1 About these instructions

This user manual supplements the installation and operating instructions for the product. It provides additional information on operation and settings on the pump. It is only valid when used in connection with the product-specific installation and operating instructions. Compliance with the instructions is essential for correct handling and use:

- Carefully read the specific product installation and operating instructions before performing any activities.
- Read this user manual carefully before carrying out any activities.
- Keep the instructions in an accessible place at all times.
- Observe all product specifications.
- Observe the markings on the product.

The language of the original operating instructions is German. All other languages of these instructions are translations of the original operating instructions.

### 1.2 Identification of safety instructions



#### NOTICE

**All safety instructions in the associated installation and operating instructions must also be observed!**

This user manual sets out safety instructions for preventing personal injury and material damage. These safety instructions are shown differently:

- Safety instructions relating to personal injury start with a signal word, are **preceded by a corresponding symbol** and are shaded in grey.



#### DANGER

**Type and source of the danger!**

Consequences of danger and instructions for avoidance.

- Safety instructions relating to property damage start with a signal word and are displayed **without** a symbol.

#### CAUTION

**Type and source of the danger!**

Consequences or information.

#### Signal words

- **DANGER!**  
Failure to follow the instructions will result in serious injuries or death!
- **WARNING!**  
Failure to follow the instructions can lead to (serious) injury!
- **CAUTION!**  
Failure to follow the instructions can lead to potentially irreparable property damage as well as to total loss.
- **NOTICE!**  
Useful information on handling the product

#### Symbols

These instructions use the following symbols:

 General danger symbol

 Danger caused by electric voltage

 Notes

### Identifying Cross References

The name of the section or table is in inverted commas [“ ”]. The page number follows in square brackets [ ].

## 1.3 Personnel qualifications

Staff must:

- be instructed about locally applicable regulations governing accident prevention,
- have read and understood the installation and operating instructions.
- have read and understood the user manual.
- The product must be operated by persons who have been instructed on how the complete system functions.

The operator must confirm and ensure the field of authority, the competence and the monitoring of the personnel. If the personnel do not possess the necessary knowledge, they must be trained and instructed. If required, this can be carried out by the product manufacturer at the operator’s request.

## 2 Pump operation

### 2.1 Description of operating elements

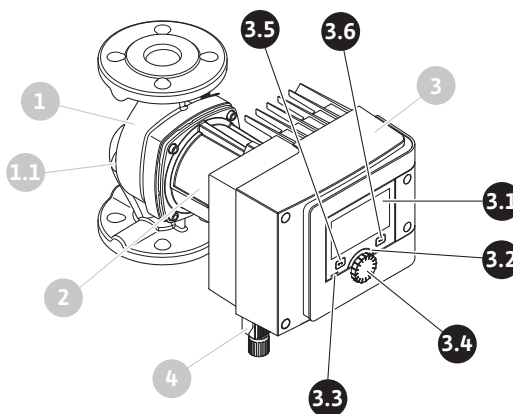

Fig. 1: Operating elements (single pump)

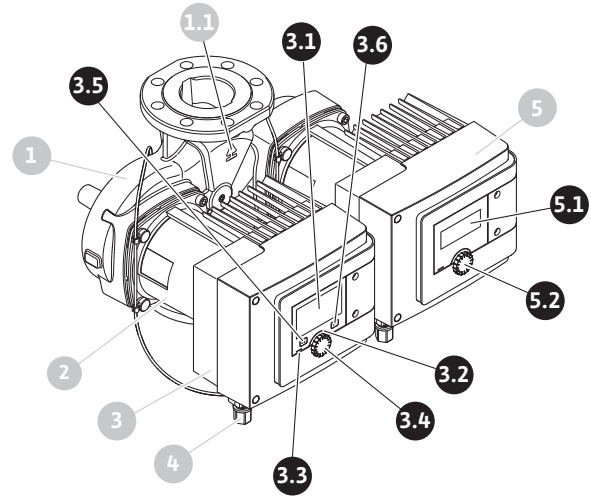



Fig. 2: Operating elements (double pump)

Item	Name	Explanation
3.1	Graphic display	Provides information about settings and pump status. Self-explanatory user interface for setting the pump. The display screen cannot be rotated.
3.2	Green LED indicator	LED is lit up: Pump is supplied with voltage and ready for operation. There are no warnings and no faults.
3.3	Blue LED indicator	LED is lit up: Pump is influenced externally via an interface, e.g. by: <ul style="list-style-type: none"> <li>• Bluetooth remote control</li> <li>• Setpoint specification via analogue input AI1 or AI2</li> <li>• Intervention of building automation via digital input DI1, DI2 or bus communication</li> </ul> Flashes with active twin-head pump connection.
3.4	Operating knob	Navigate menus and edit content by turning and pressing.
3.5	Back button	Menu navigation: <ul style="list-style-type: none"> <li>• To go back to the previous menu level (briefly press once).</li> <li>• To go back to the previous settings (briefly press once).</li> <li>• Return to the main menu (press and hold 1 x, &gt; 2 seconds)</li> </ul> Turns key lock on or off in combination with the Context button. > 5 seconds.
3.6	Context button	Opens the context menu with additional options and functions. Turns key lock on or off in combination with the back button. > 5 seconds.
5.1	LED display	Indicates error code and Bluetooth PIN.
5.2	LED display control knob	Triggers the pump venting function when pressed. Turning is <b>not</b> possible.

Table 1: Description of operating elements

## 2.2 Settings on pump

Carry out settings by turning and pressing the control knob. Turn the control knob to the left or right to browse the menus or configure settings. A green focus indicates navigation in the menu. A yellow focus indicates a configuration of settings.

- Green focus: Navigation in menu.
- Yellow focus: Change settings.
- Turn : Menu selection and parameter setting.
- Press : Activation of menus or confirming settings.

Press the Back button  (pos. 3.5 in section “Description of operating elements [▶ 6]”) to change the focus back to the previous focus. Consequently, the focus moves one level further up in the structure or to a previous setting.

Pressing the Back button  after having changed a setting (yellow focus) without confirming the changed value returns the focus to the previous focus. The adjusted value will be discarded. The previous value remains unchanged.

If the Back button  is pressed for more than 2 seconds, the Home screen opens and the pump can be operated from the main menu.



## NOTICE

If there are no warning or error messages, the display on the electronic module will switch off 2 minutes after the last time it was operated.

- If the control knob is pressed or turned again within 7 minutes, the previously exited menu will appear. You can continue to configure settings.
- If the control knob is not pressed or turned for more than 7 minutes, any unconfirmed settings will be lost. Pressing the button again opens the Home screen on the display and the pump can be operated from the main menu.

## 2.3 Initial settings menu

The settings menu will appear in the display during initial commissioning of the pump.

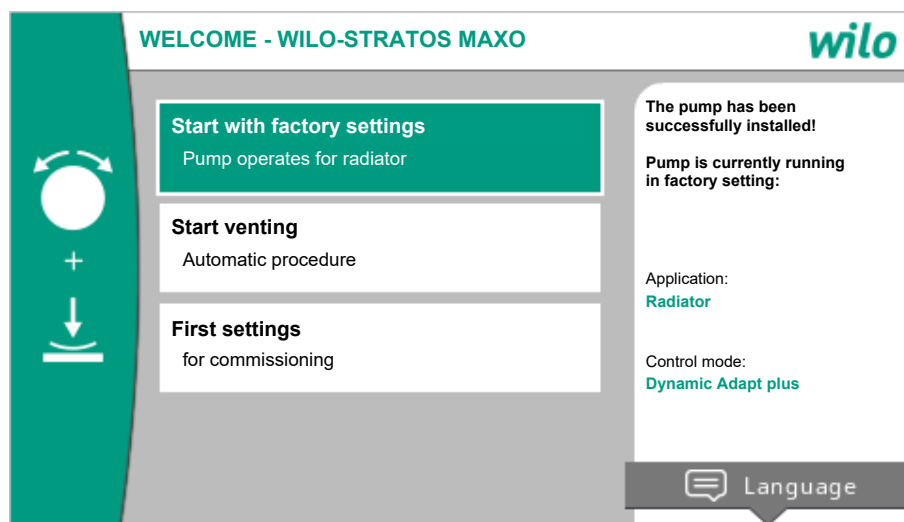

Fig. 3: Initial settings menu

If necessary, press the Context button  and go to the Language menu to change the language.

The pump runs in factory setting when the initial commissioning menu is open. For detailed information on the factory setting, see “Factory setting [▶ 49]” section

- You can exit the initial settings menu by activating “Start with factory settings” menu by pressing the control knob. The display changes to the main menu. The pump continues to run in the factory setting.
  - Stratos MAXO/Stratos MAXO-D: The pump runs in the factory setting → Application: Radiator; Control mode: Dynamic Adapt plus.
  - Stratos MAXO-Z: The pump runs in the factory setting → Application: Domestic hot water circulation; control mode: Temperature  $T_{\text{const}}$ .
- If venting has been started, other settings can be made in the meantime. (For information on pump venting, see “Pump venting [▶ 52]” section).
- You can select and set language, units, applications and night setback, among other things, in the “First settings” menu.
 

The chosen initial settings are confirmed by activating “Finish initial settings”. The display changes to the main menu.



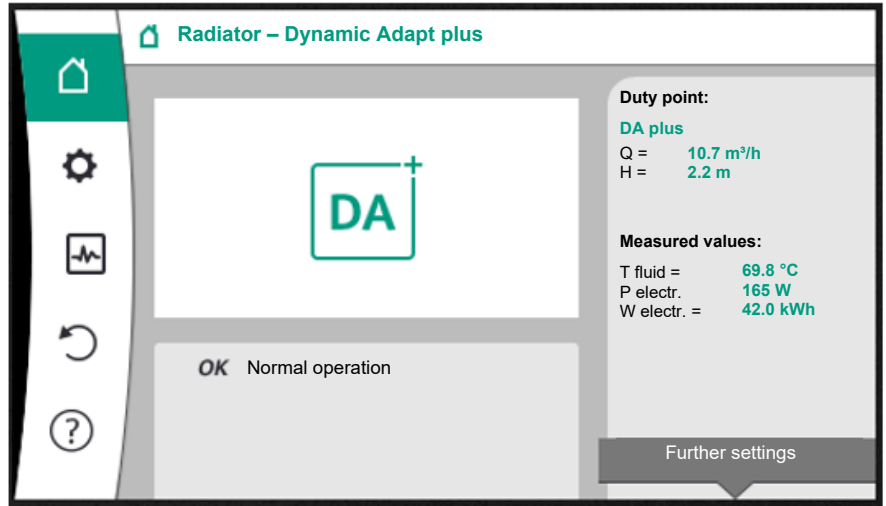



Fig. 4: Main menu

2.4 Home screen

Setpoints can be changed in the “Home screen” menu.

The home screen can be selected  by turning the control knob to the “House” symbol. Pressing the control knob activates the setpoint adjustment. The frame of the changeable setpoint turns yellow.

The setpoint is changed by turning the control knob right or left.

Pressing the control knob again confirms the changed setpoint. The pump accepts the value and the display returns to the main menu.

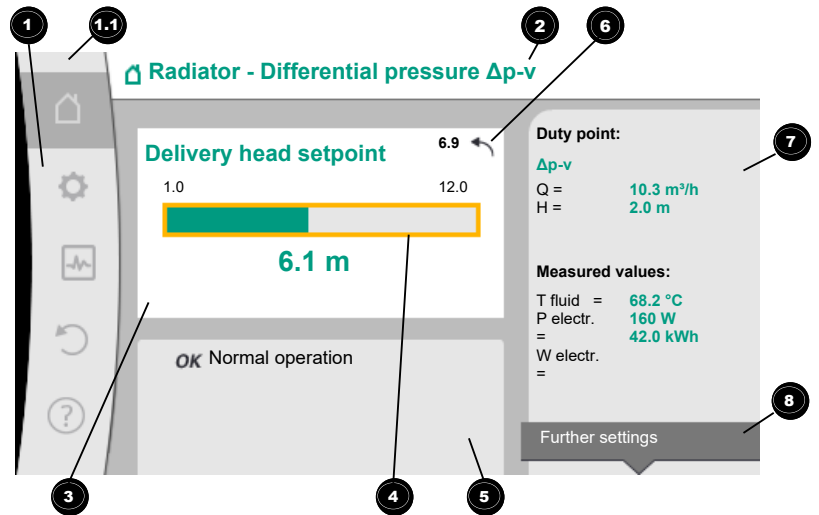



Fig. 5: Home screen

Pos.	Name	Explanation
1	Main menu over-view	Selection of different main menus
1.1	Status area: Error, warning or process information display	Indicates an on-going process, warning or error message. Blue: Process or communication status display (CIF module communication) Yellow: Warning Red: Fault Grey: There are no processes running in the background, there are no warning or error messages.
2	Title bar	Display of currently set application and control mode.
3	Setpoint display field	Displays currently configured setpoints.
4	Setpoint editor	Yellow frame: You have pressed the operating button to open the setpoint editor and change the value.

Pos.	Name	Explanation
5	Active influences	Display of influences on set control mode e.g. active setback operation, No-Flow Stop OFF (see table entitled “ <b>Active influences</b> ”). You can display up to five active influences.
6	Reset reference	Shows the value before having changed it when the set-point editor is active. The arrow shows that you can go back to the previous value with the Back button.
7	Operating data and measurement area	Shows current operating data and measured values.
8	Context menu reference	Offers context-related options in a separate context menu.

Table 2: Home screen

If the Home screen is not displayed, press the  icon in the main menu or hold the Back button  for more than one second to open the Home screen.

All user interactions are initiated from the Home screen. The display returns to the Home screen if the system is not operated for > 7 minutes.

The Home screen provides a comprehensive overview of the pump status.

**The title bar**  indicates the currently active application and associated control mode.

**In the setpoint editor** , the setpoint is shown.

Press the control knob to adjust the setpoint. The frame of the variable setpoint turns yellow which indicates that it has been activated. The setpoint is changed by turning the control knob right or left. The changed setpoint is confirmed by pressing the control knob again. The value is transferred to the pump and the focus returns to the Home screen.

Pressing the Back button  during setpoint adjustment discards the changed setpoint and retains the old setpoint. The focus returns to the Home screen.



#### NOTICE

Setpoint adjustment is not possible when Dynamic Adapt plus is active.





#### NOTICE







Pressing the context button  will display additional context-related options for further settings.

**In the operating data and measurement area** , important operating parameters (e.g. current duty point) and other measured values are displayed.

**In the “Active influences” area** , influences that currently influence the pump (e.g. one active EXT. OFF function) are displayed.

Possible “Active influences”:

Sym- bol	Information	Meaning
		Peak-load operation Solid pump symbol: Motor running on this side of the pump. The graphic display has been installed on the left.
		Main/standby operation Solid pump symbol: Motor running on this side of the pump. The graphic display has been installed on the left.
<b>OK</b>		Pump continues to run in the configured control mode without additional influences.

Sym- bol	Information	Meaning
<b>OFF</b>	Override OFF	<p>Override OFF active. Pump is switched off with maximum priority. The pump is stationary.</p> <p>Indication of activating override source:</p> <ol style="list-style-type: none"> <li>If not otherwise indicated: Override caused by request from HMI or CIF module</li> <li>DI1/DI2: Override caused by request via binary input.</li> </ol>
<b>MAX</b>		<p>MAX override active. Pump running at maximum output.</p> <p>Indication of activating override source:</p> <ol style="list-style-type: none"> <li>If not otherwise indicated: Override caused by request from HMI or CIF module</li> <li>DI1/DI2: Override caused by request via binary input.</li> </ol>
<b>MIN</b>		<p>MIN override active. Pump running at minimum output.</p> <p>Indication of activating override source:</p> <ol style="list-style-type: none"> <li>If not otherwise indicated: Override caused by request from HMI or CIF module</li> <li>DI1/DI2: Override caused by request via binary input.</li> </ol>
		<p>MANUAL override active. Pump running in control mode defined for MANUAL with a setpoint adjusted for MANUAL.</p> <p>Indication of activating override source:</p> <ol style="list-style-type: none"> <li>If not otherwise indicated: Override caused by request from HMI or CIF module</li> <li>DI1/DI2: Override caused by request via binary input.</li> <li>BA error: If monitored telegrams as part of building automation bus communication are not received, the mode returns to MANUAL.</li> </ol>
		<p>Automatic detection of disinfection active. Disinfection detected. The pump supports disinfection at maximum output.</p>
		<p>Detecting night setback switched on. Night setback of the heat generator detected. Pump running with adapted, reduced output.</p>
		<p>Detecting night setback switched on. Pump running in day-time operation in the adjusted control mode.</p>
<b>OFF</b>	Context menu pump ON/OFF	<p>Pump switched on in the menu using "Pump ON/OFF". Override possible with:</p> <ul style="list-style-type: none"> <li>MANUAL override</li> <li>MIN override</li> <li>MAX override</li> </ul>
<b>OFF</b>	Setpoint analogue input	<p>Pump switched off by setpoint at analogue input. Override possible with:</p> <ul style="list-style-type: none"> <li>MANUAL override</li> <li>MIN override</li> <li>MAX override</li> </ul>
	Deviation speed	<p>Special status (e.g. missing sensor value) leads to restricted emergency operation at a speed set for this purpose in the menu. This status is always accompanied by a warning providing more information about the status.</p>
	Dry run (venting)	<p>Air detected in the rotor chamber. Pump attempting to evacuate air from the rotor chamber.</p>





Symbol	Information	Meaning
	Pump kick active	The pump activates after a configured time interval and once again switches off after a short time to prevent the pump from blocking.
		Pump is venting and therefore not controlling as per adjusted control function.
<b>STOP</b>	No-Flow Stop	No-Flow Stop detection active. Value dropped below the adjusted, lower volume flow limit. Pump operation stopped. The pump checks every 5 minutes if there is demand and resumes pumping if necessary.
		The Q-Limit <sub>Max</sub> function has been activated and the adjusted maximum volume flow has been reached. The pump restricts the volume flow to this adjusted value.
		The Q-Limit <sub>Min</sub> function has been activated and the adjusted minimum volume flow has been reached. The pump guarantees the volume flow within its characteristic curve.
		Pump supplying within maximum characteristic curve range.

Table 3: Active influences

## 2.5 Main menu







Symbol	Meaning
	Home screen
	Settings
	Diagnostics and measured values
	Restore and reset
	Help

Table 4: Main menu symbols

After quitting the initial commissioning menu, all operations are initiated from the main menu on the "Home screen". In this process, the current operating focus has been highlighted in green. Turn the control knob to the left or right to focus on a different main menu. The corresponding sub-menu for each focussed main menu is now displayed. Press the control knob to change the focus to the corresponding sub-menu. If the operating focus is on "Home screen" and you press the control knob, the setpoint editor is activated (yellow frame). You can adjust the setpoint value.

Press and hold the Back button  for more than one second if the operating focus is not on the main menu as a result of previous operational steps.

## 2.6 Sub-menu

Each sub-menu is made up of a list of sub-menu items. Each sub-menu item consists of a title and an information bar. The title lists an additional sub-menu or a downstream settings dialogue. The information bar shows descriptive information about the available sub-menu or the downstream settings dialogue. The information bar of a settings dialogue shows the set value (e.g. a setpoint). With this display, you can check settings without having to open the settings dialogue.

## 2.7 "Settings" sub-menu

Different settings can be changed in the "Settings" menu .

Turn the control knob to the "Gear wheel" icon  to select the "Settings" menu. Press the control knob to change the focus to the "Settings" sub-menu.

Turn the control knob to the left or right to select a sub-menu item. The selected sub-menu item has been highlighted in green.

Press the control knob to confirm your selection. The selected sub-menu or downstream

settings dialogue appears.



## NOTICE

There is an arrow **1** above or below the visible menu items if there are more than four sub-menu items. Turn the control knob in the corresponding direction to open the sub-menu items on the display.

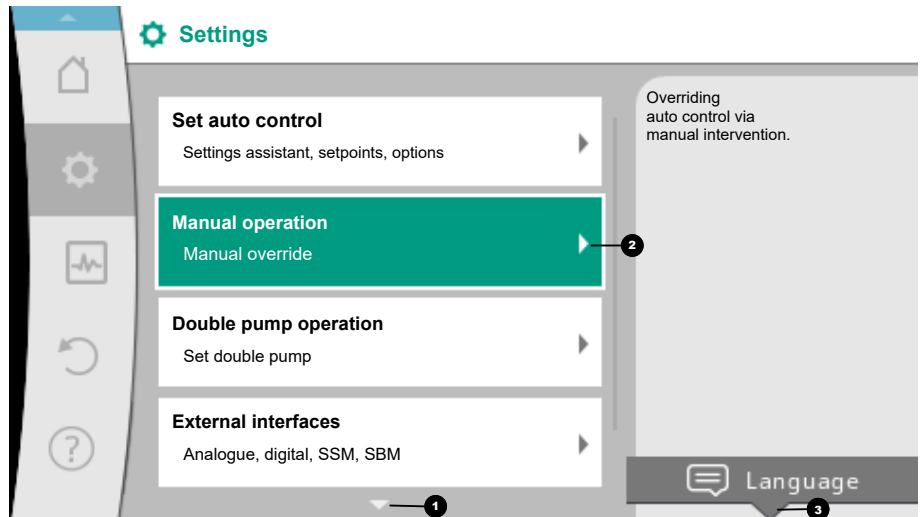

Fig. 6: Settings menu

An arrow **1** above or below a menu area indicates that additional sub-menu items are available in this area. These sub-menu items are accessible by turning the control knob.

An arrow **2** towards the right in a sub-menu item indicates that another sub-menu is available. Press the control knob to open this sub-menu.

If there is no arrow to the right, press the control knob to open a settings dialogue.

A note **3** above the “Context” button shows specific functions of the “Context” menu. Press the “Context” menu button to open the “Context” menu.



## NOTICE

Briefly press the Back button in a sub-menu to return to the previous menu.

Briefly press the Back button in the main menu to return to the Home screen. If there is an error, press the Back button to return to the error display (Error messages [▶ 83] section).

If there is an error, press and hold the Back button (> 1 second) from any settings dialogue or from any menu level to return to the Home screen or error display.

## 2.8 Settings dialogues

Settings dialogues have been highlighted with a yellow frame and show the current setting.

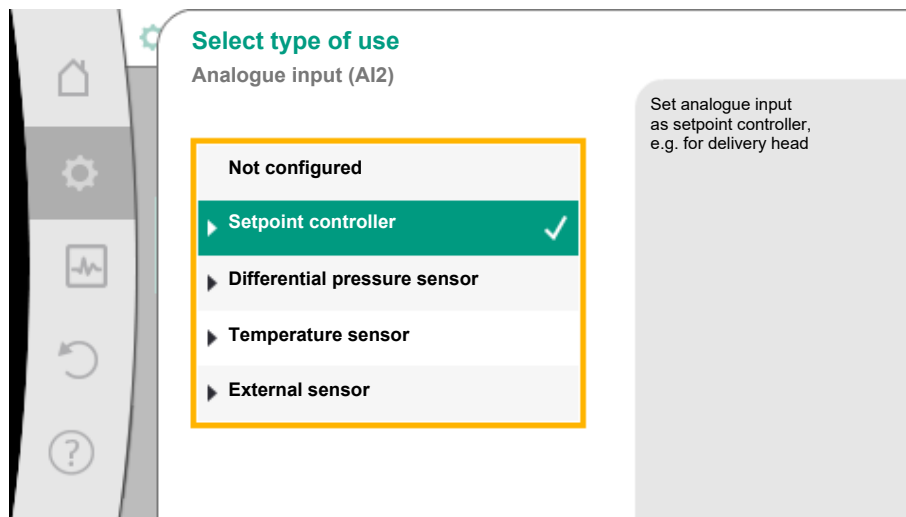

Fig. 7: Settings dialogue

Turn the control knob to the right or left to adjust the highlighted setting.

Press the control knob to confirm the new setting. The focus returns to the menu you opened.

If you do not turn the control knob before pressing, the previous setting remains unchanged.

One or more parameters can be set in the settings dialogues.

- If only one parameter can be set, the focus returns to the menu you opened after having confirmed the parameter value (pressing the control knob).
- If several parameters can be set, the focus changes to the next parameter after having confirmed a parameter value.

If you confirm the last parameter in the settings dialogue, the focus returns to the menu you opened.

Press the “Back” button  to return the focus to the previous parameter. The previously changed value will be discarded because it had not been confirmed.

Press the control knob to check set parameters and switch between them. In this process, existing parameters are once again confirmed, but not changed.



### NOTICE

Press the control knob without selecting another parameter or adjusting another value to confirm the setting.

Press the Back button  to discard the current adjustment and retain the previous setting. The menu changes to the previous setting or previous menu.



### NOTICE

Pressing the Context button  will display additional context-related options for further settings.

## 2.9 Status area and status displays

### Status area and status displays

The status area is located on the left side above the main menu area . (See also “Home screen” figure and table).

If a status is active, it is possible to display and select status menu items in the main menu. Turn the control knob to the status area to show the active status.

If an active process (e.g. venting process) is quit or discarded, the status display is hidden again.

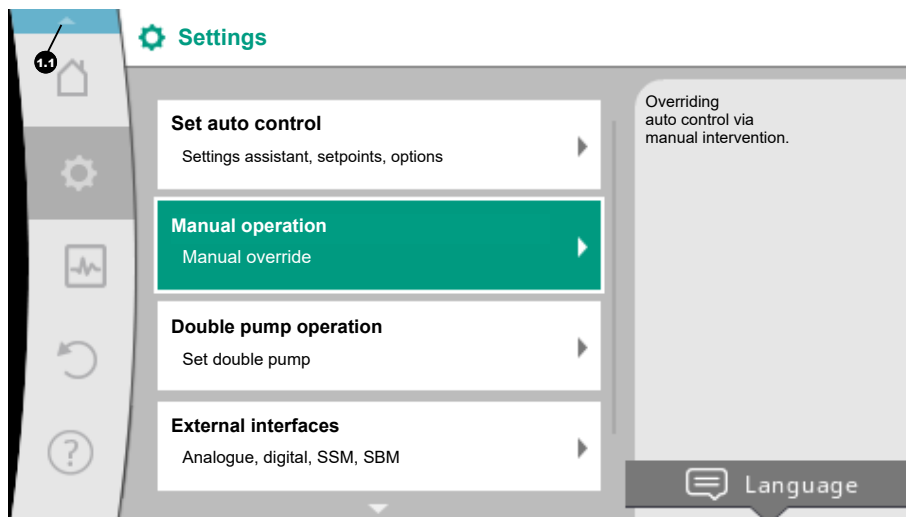

Fig. 8: Main menu status display

There are three different classes of status displays:

1. Display process:  
On-going processes have been highlighted in blue.  
Processes mean pump operation may deviate from the adjusted control.  
Example: Venting process.
2. Display warning:  
Warning messages have been highlighted in yellow.  
The pump functions are restricted if a warning has been output. (See the “Warning messages [▶ 85]” section).  
Example: Cable break detection on analogue input.
3. Display error:  
Error messages have been highlighted in red.  
The pump stops operation if an error has occurred. (See section “Error messages [▶ 83]”).  
Example: Ambient temperature too high.

Example of a process display. Here: “Venting”

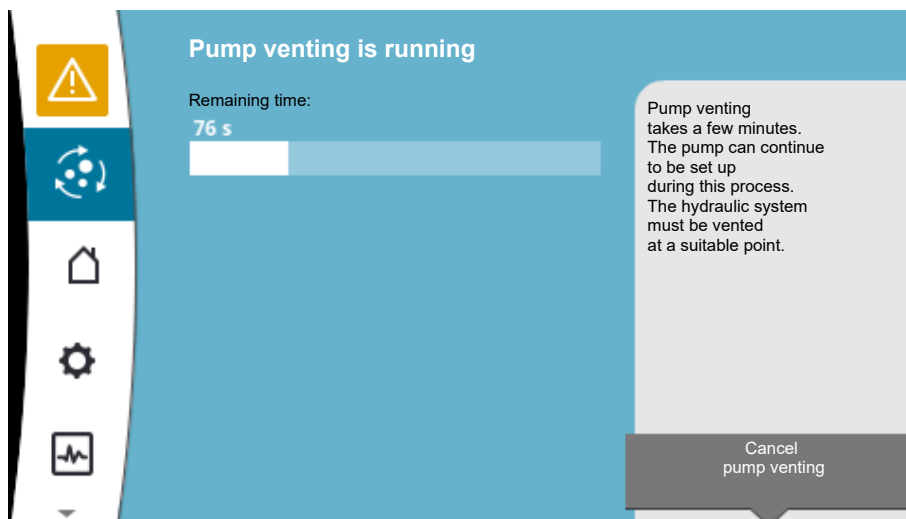

Fig. 9: Status display venting

The “Venting” icon has been selected in the main menu. The venting process is active and information about venting is displayed.

Further status displays can be displayed, if they are available, by turning the control knob to the corresponding symbol.

Symbol	Meaning
	Error message <b>Pump stopped!</b>





Symbol	Meaning
	Warning message <b>Pump operation restricted!</b>
	Active venting <b>Venting in progress. Subsequently returns to normal operation.</b>
	Communication status – a CIF module has been installed and is active. <b>Pump in control mode, monitoring and control by building automation available.</b>
	Software update started – transfer and verification <b>Pump continues to run in control mode until the update bundle has been fully transferred and verified.</b>

Table 5: Potential data displayed in the status area

Additional settings can be made in the context menu. For this purpose, press the Context button .

Press the Back button  to return to the main menu.

You can already make additional settings at the pump during the venting process. These settings become active when the venting process is completed.



**NOTICE**

Any set control mode is interrupted while a process is running. After completing the process, the pump continues to run in the set control mode.



**NOTICE**

**Behaviour of the back button  in case of an error message of the pump.**

Repeatedly pressing or pressing and holding the Back button after an error message has occurred will open the “Error” status display and not take you back to the main menu. The status area is highlighted in red.

**3 Setting the control functions**

**3.1 Basic control functions**

**3.1.1 Constant speed (n-const / constant speed)**

Basic control functions are available depending on the application. Select control functions using the setting assistant.

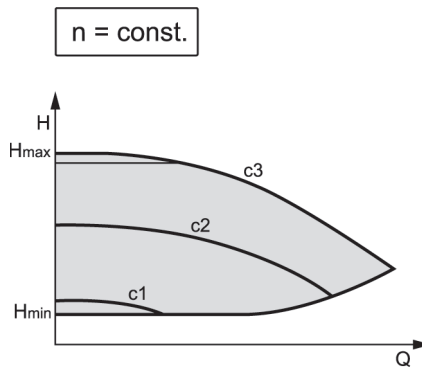

Fig. 10: Speed constant

The speed of the pump is kept at a set constant speed. The speed range depends on the pump type.



### 3.1.2 Differential pressure $\Delta p\text{-c}$

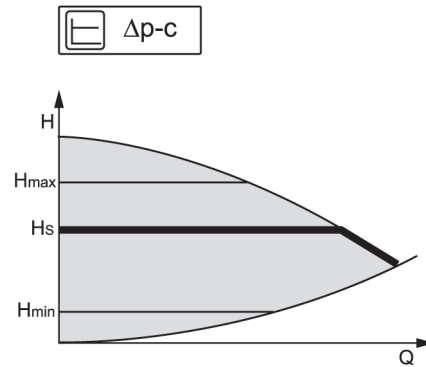

Fig. 11: Differential pressure  $\Delta p\text{-c}$

The control keeps the differential pressure generated by the pump constant over the permissible flow rate range at the set differential pressure setpoint  $H_{\text{set}}$  up to the maximum characteristic curve.

An optimised constant differential pressure control is available for the corresponding pre-defined applications.

Assuming a required delivery head to be set according to the design point, the pump variably adjusts the pump output to the required volume flow. The volume flow varies due to the open and closed valves on the consumer circuits. The pump output is adjusted to the requirements of the consumer load and the energy requirement is reduced.

$\Delta p\text{-c}$  is used in circuits with variable pressure and volume flows, e.g. underfloor heating or ceiling cooling. A hydronic balancing is required in all circuits mentioned.

### 3.1.3 Index circuit $\Delta p\text{-c}$

An optimised constant differential pressure control is available for “index circuit  $\Delta p\text{-c}$ ”. This differential pressure control ensures supply in a widely branched, possibly poorly balanced system.

The pump takes into account the point in the system which is the most unfavourable to supply.

For this purpose, the pump requires a differential pressure sensor which is installed at this point (“index circuit”) in the system.

The delivery head must be adjusted to the required differential pressure. The pump output is adjusted to this point as required.



#### NOTICE

Noise may occur in the system. Hydronic balancing is recommended.

### 3.1.4 Differential pressure $\Delta p\text{-v}$

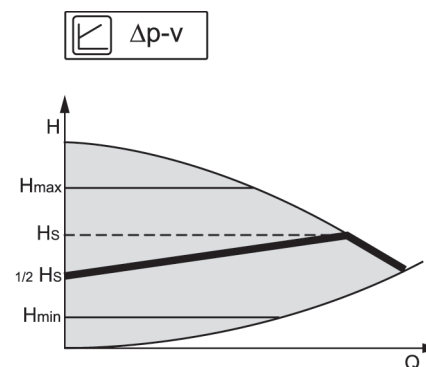

Fig. 12: Differential pressure  $\Delta p\text{-v}$

The control triggers a linear change in the differential pressure setpoint the pump must ensure between reduced differential pressure  $H$  and  $H_{\text{set}}$ .

The controlled differential pressure  $H$  increases or decreases with the flow rate.

The slope of  $\Delta p\text{-v}$  characteristic curve can be adjusted to the respective application by setting the percentage of  $H_{\text{set}}$  (slope  $\Delta p\text{-v}$  characteristic curve).



#### NOTICE

Options “Nominal duty point  $Q$ ” and “Slope of  $\Delta p\text{-v}$  characteristic curve” are available in the context menu [•••] of the setpoint editor “ $\Delta p\text{-v}$  differential pressure setpoint”.

$\Delta p-c$  is used in circuits with variable pressure and volume flows, e.g. radiators with thermostatic valves or air-conditioning devices.

A hydronic balancing is required in all circuits mentioned.

### 3.1.5 Dynamic Adapt plus

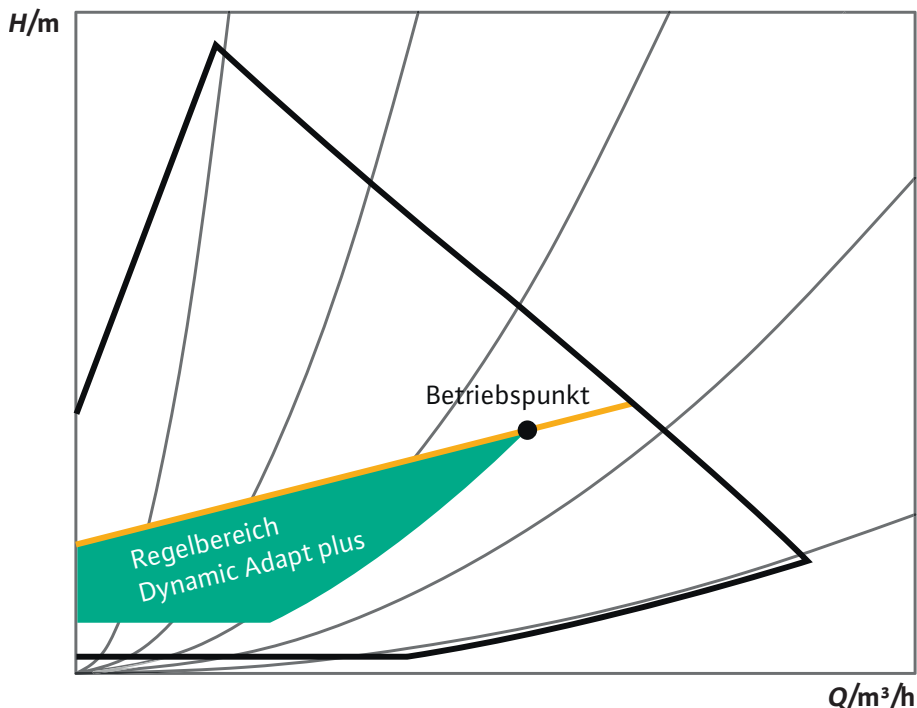

Fig. 13: Dynamic Adapt plus control range

The control mode Dynamic Adapt plus autonomously adjusts the pump output to the requirements of the system. Setpoint adjustment is not necessary.

It is optimal for circuits whose design points are unknown.

The pump continuously adjusts its delivery rate to the requirements of the consumer and status of the open and closed valves and thus significantly reduces the set pump energy.

Dynamic Adapt plus is used in consumer circuits with variable pressure and volume flows, e.g. radiators with thermostatic valves or underfloor heating with room-controlled actuating drives.

Hydronic balancing is required in all circuits mentioned.



#### NOTICE

In hydraulic circuits with invariable resistances, such as generator circuits or feeder circuits (to hydraulic shunts, differential pressure-less distributors or heat exchangers), another control mode has to be selected, e.g. volume flow constant (Q-const), differential temperature constant ( $\Delta T$ -const), differential pressure ( $\Delta p-c$ ) or Multi-Flow Adaptation.

### 3.1.6 Temperature constant (T-const)

Factory setting for domestic hot water circulator

The pump constantly adjusts to a set temperature  $T_{\text{setpoint}}$ .

Current temperature determination:

- Through an internal temperature sensor (not available with “-R7” version)
- Through an external temperature sensor which is connected to the pump



#### NOTICE

The control function T-const. can be used with an external sensor (e.g. PT1000) for “-R7” version. The external sensor is connected to the AI1 or AI2 analogue inputs.

The “internal sensor” as sensor source T1 or T2 is not available with the “-R7” version.

### 3.1.7 Differential temperature constant ( $\Delta T$ -const)

The pump controls to a set differential temperature  $\Delta T_{\text{setpoint}}$  (e.g. difference from feed and return temperature).

Actual temperature determination:

- Through the internal temperature sensor (not available with “-R7” version) and an external temperature sensor.
- Two external temperature sensors.



### NOTICE

The control function  $\Delta T$ -const. can be used with an external sensor (e.g. PT1000) for “-R7” version. The external sensor is connected to the AI1 or AI2 analogue inputs.

The “internal sensor” as sensor source T1 or T2 is not available with the “-R7” version.

### 3.1.8 Volume flow constant (Q-const)

The pump controls a set volume flow  $Q_{set}$  in its characteristic curve.

### 3.1.9 Multi-Flow Adaptation

The volume flow in the generator or feeder circuit (primary loop) is adjusted to the volume flow in the consumer circuits (secondary loop) with the Multi-Flow Adaptation control mode.

Multi-Flow Adaptation is set on the Wilo-Stratos MAXO feeder pump in the primary circuit upstream of a hydraulic shunt or a heat exchanger.

The Wilo-Stratos MAXO feeder pump is connected to the Wilo-Stratos MAXO pumps in the secondary circuits with Wilo Net data cable.

The feeder pump continuously receives the respective required volume flow from each individual secondary pump at short intervals.

The sum of the required volume flows from all secondary pumps is set by the feeder pump as the setpoint volume flow.

To adapt the supply to local conditions, a correction factor (80 – 120%) and a fixed volume flow rate can be set. The fixed volume flow percentage is always calculated for the calculated volume flow.

On commissioning, all associated secondary pumps must be registered with the primary pump so that it can take their volume flows into consideration. For more information on the installation and operation of Multi-Flow Adaptation, see the “Setting up Multi-Flow Adaptation” section [► 39].



### NOTICE

The Multi-Flow Adaptation application can only be used in systems where the primary loop is separated pressure-free from the secondary loop by means of a heat exchanger or hydraulic shunt.



### NOTICE

When replacing a Stratos MAXO pump with SW  $\geq$  01.04.19.00 in an existing Multi-Flow Adaptation system with pumps that have a lower SW version (SW  $<$  01.04.19.00), all integrated Stratos MAXO pumps must be updated to a higher SW version (SW  $\geq$  01.04.19.00).

For pumps with a SW version (SW  $\geq$  01.04.19.00), it is not strictly necessary for the primary circuit pump and the secondary pumps to have the same SW version.

### 3.1.10 User-defined PID control

The pump controls based on a user-defined control function. PID control parameters Kp, Ki and Kd have to be manually set.

The PID controller used in the pump is a standard PID controller.

The controller compares the measured actual value with the specified setpoint and attempts to match the actual value to the setpoint as closely as possible.

Provided the appropriate sensors are used, various controls can be implemented.

When selecting a sensor, attention must be paid to the configuration of the analogue input. The control behaviour can be optimised by changing the P, I and D parameters.

The direction of control action can be adjusted by switching the control inversion on or off.

## 3.2 Additional control functions



### NOTICE

Additional control functions are not available for all applications!

These additional control functions are available depending on the application:

- Night setback
- No-Flow Stop
- Q-Limit<sub>Max</sub>
- Q-Limit<sub>Min</sub>
- Nominal duty point Q
- Gradient of the  $\Delta p$ -v characteristic curve
- Multi-Flow Adaptation mixer (from SW  $\geq$  01.05.10.00)

### 3.2.1 Night setback

The night setback function is adaptive: After a learning phase, the  $dT/dt$  (temperature/time) behaviour is assessed in connection with adaptive tolerance ranges.

This assessment results in the speed being reduced or an existing speed reduction being exited again.

The adaptive algorithm used attempts to eliminate interference effects (such as burner peaks during assessment).

Even at low water temperatures (e.g. underfloor heating), the algorithm attempts to recognise a lack of demand for speed reduction.

Reduction takes place in the order normal operation, transition and night. The return process goes directly from night to normal operation. If night setback is active, the setback speed can be taken from the characteristic curve data sheet for  $\Delta p$ -v or  $\Delta p$ -c for each individual variant.

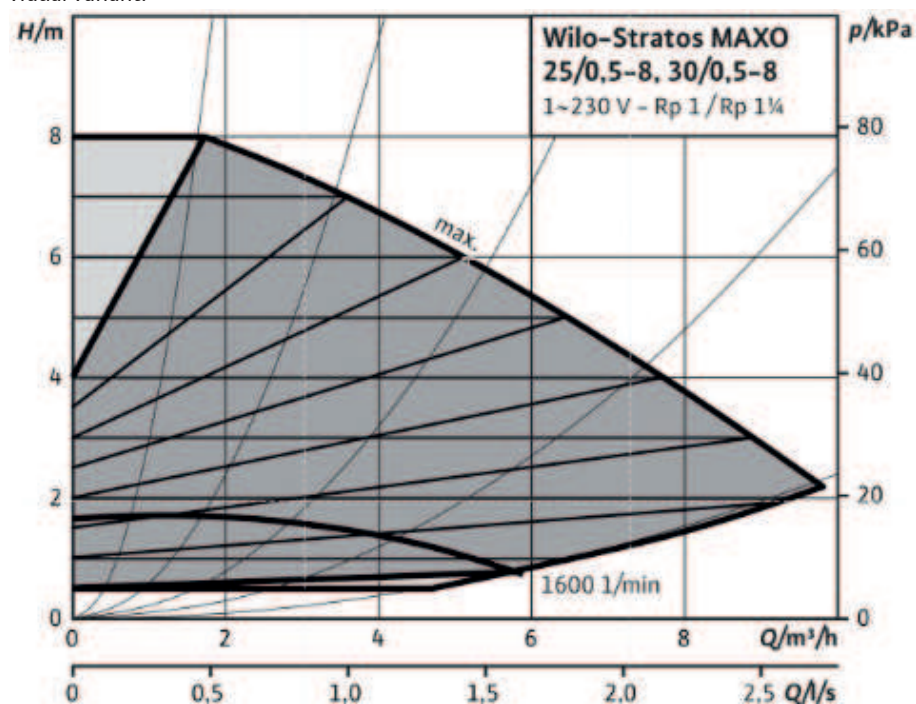

### NOTICE

The additional control function "night setback" is an energy-saving function. Avoiding unnecessary running times thus saves electrical pump energy.

This function is deactivated in the factory settings and must be activated if required.

## CAUTION

### Property damage caused by frost!

The night setback may be activated only if hydronic balancing of the system has been completed!

In case of non-compliance, inadequately supplied system parts may freeze due to frost!

- Carry out hydronic balancing!



## NOTICE

The additional control function “Night setback” cannot be combined with the additional control function “No-Flow Stop”!

The additional control function “Night setback” cannot be used with the “-R7” version.

### 3.2.2 No-Flow Stop

The additional control function “No-Flow Stop” continuously monitors the actual volume flow of the heating/cooling system.

If the volume flow decreases due to closing valves and falls below the “No-Flow Stop Limit” threshold set for No-Flow Stop, the pump is stopped.

The pump checks every 5 minutes (300 s) whether the volume flow demand is increasing again. When the volume flow increases again, the pump continues running in its set control mode in normal operation.



## NOTICE

A volume flow increase relative to the set minimum volume flow “No-Flow Stop Limit” is checked within a time interval of 10 s.



## NOTICE

The test time of 5 minutes is permanently set and cannot be adjusted.

The reference volume flow  $Q_{ref}$  can be set between 1% and 20% of the maximum volume flow  $Q_{Max}$  depending on the pump size.

Field of application of No-Flow Stop:

A pump in a consumer circuit with control valves in heating or cooling (with radiators, fan heaters, air-conditioning devices, underfloor heating/cooling, ceiling heating/cooling, concrete core heating/cooling) as an additional function for all control modes except Multi-Flow Adaptation and volume flow  $Q_{const}$ .



## NOTICE

This function is deactivated in the factory settings and must be activated if required.



## NOTICE

The additional control function “No-Flow Stop” is an energy-saving function. Reducing unnecessary running times saves electrical pumping energy.



## NOTICE

The additional “No-Flow Stop” control function is available for suitable applications only! The additional control function “No-Flow Stop” cannot be combined with the additional control function “Q-Limit<sub>Min</sub>”!

### 3.2.3 Q-Limit Max

The additional control function “Q-Limit<sub>Max</sub>” can be combined with other control functions (differential pressure control ( $\Delta p-v$ ,  $\Delta p-c$ ), cumulated volume flow, temperature control ( $\Delta T$  control, T control)). It makes it possible to limit the maximum volume flow to approx. 10 % – 90 %, depending on pump type. When the set value is reached, the pump is controlled on the characteristic curve along the limit – never beyond.

#### CAUTION

##### Property damage caused by frost!

When using Q-Limit<sub>Max</sub> in non-hydraulically balanced systems, some areas can be inadequately supplied and freeze!

- Carry out hydronic balancing!



#### NOTICE

The Q-Limit<sub>Max</sub> function is not available with an external setpoint specification of e.g. 0 to 10 V.

### 3.2.4 Q-Limit Min

The additional control function “Q-Limit<sub>Min</sub>” can be combined with other control functions (differential pressure control ( $\Delta p-v$ ,  $\Delta p-c$ ), cumulated volume flow, temperature control ( $\Delta T$  control, T control)). It makes it possible to ensure the minimum volume flow to a set value 10 % – 90 % of Q<sub>Max</sub> within the hydraulic characteristic curve. When the set value is reached, the pump is controlled on the characteristic curve along the limit until the maximum delivery head is reached.



#### NOTICE

The additional “Q-Limit<sub>Min</sub>” control function cannot be combined with the additional “No-Flow Stop” control function!

### 3.2.5 Nominal duty point Q

The nominal duty point is set using the Context button

The optionally configurable nominal duty point for the differential pressure control  $\Delta p-v$  significantly simplifies adjustment by adding the required volume flow at the design point. The additional input of the required volume flow at the design point ensures that the  $\Delta p-v$  characteristic curve runs through the design point.

The slope of the  $\Delta p-v$  characteristic curve is optimised.

### 3.2.6 Gradient $\Delta p-v$ characteristic curve

A factor can be set on the pump to optimise the  $\Delta p-v$  control characteristic.

The additional function “Slope of  $\Delta p-v$  characteristic curve” can only be used for the differential pressure control  $\Delta p-v$ .

The slope of the  $\Delta p-v$  characteristic curve is set via the Context button . The factor 50 % ( $\frac{1}{2} H_{set}$ ) is pre-set at the factory.



#### NOTICE

In some installations with special pipe network characteristics, there may be inadequate or excessive supply. The factor reduces (< 50 %) or increases (> 50 %) the  $\Delta p-v$  delivery head at  $Q=0 \text{ m}^3/\text{h}$ .

- Factor < 50 %:  $\Delta p-v$  characteristic curve becomes steeper.
- Factor > 50 %:  $\Delta p-v$  characteristic curve becomes flatter.
- Factor 100 % is equal to an  $\Delta p-c$  control.

The excessive or inadequate supply can be compensated by adjusting the factor.

- In case of inadequate supply in the partial load range, the value must be increased.
- In case of excessive supply in the partial load range, the value can be reduced. More energy can be saved and flow noises are reduced.



## NOTICE

The additional function “Slope of  $\Delta p$ -v characteristic curve” can save energy and reduce flow noise.

### 3.2.7 Multi-Flow Adaptation mixer (from SW $\geq$ 01.05.10.00)

In the case of secondary circuits with in-built 3-way mixers, the mixed volume flow can be calculated so that the primary pump takes the actual demand of the secondary pumps into account. To do this, the following has to be carried out:

Temperature sensors must be fitted to the secondary pumps in the respective feed and return of the secondary loops, integrated, and the heating or cooling quantity measurement activated.

Temperature sensors must also be fitted to the feeder pump at the primary feed upstream of the heat exchanger or hydraulic shunt and at the secondary feed behind it. The function Multi-Flow Adaptation mixer is activated on the feeder pump.

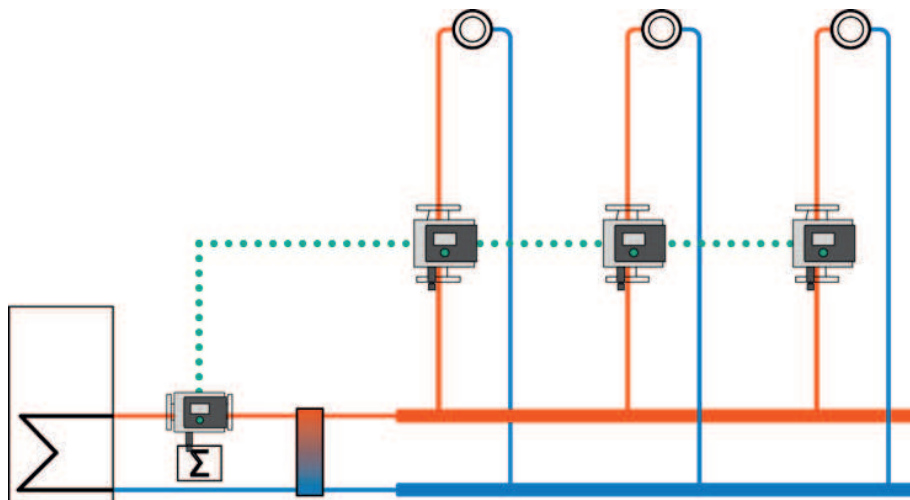

Fig. 14: Multi-Flow Adaptation



## NOTICE

Once the “Multi-Flow Adaptation mixer” additional function has been activated, two further sub-menus appear in the “Set control mode” menu: “Temperature sensor T1” and “Temperature sensor T2”. For setting, see “Step 2 – Setting Multi-Flow Adaptation on the primary circuit pump [► 42]” section

### 3.2.8 Detection of thermal disinfection

The Stratos MAXO-Z uses a sensor connected to the hot water tank or the hot water output line to detect when the hot water temperature exceeds a specified limit value. It detects that thermal disinfection has been started and thus continues to supply at full speed.

The “Detection of disinfection” function has been provided in the “Set control mode” menu after having selected the “Drinking water – temperature T-const” application in the setting assistant.

This function monitors the feed temperature at the hot water source with an external temperature sensor in order to record the significant increase of temperature in case of thermal disinfection.

Once the system detects thermal disinfection, the pump switches to maximum output to support disinfection and rinse the system with hot water.



## NOTICE

If the “Detection of disinfection” option is not used, the pump reduces the power when it detects a temperature increase. Thermal disinfection is prevented.

## 4 Settings and configuration

### 4.1 Settings assistant

With the setting assistant, it is no longer necessary to be familiar with the matching control mode and additional options of the corresponding application.

You can select the matching control mode and additional options in the application's setting assistant.

You can also directly select a basic control mode in the setting assistant.

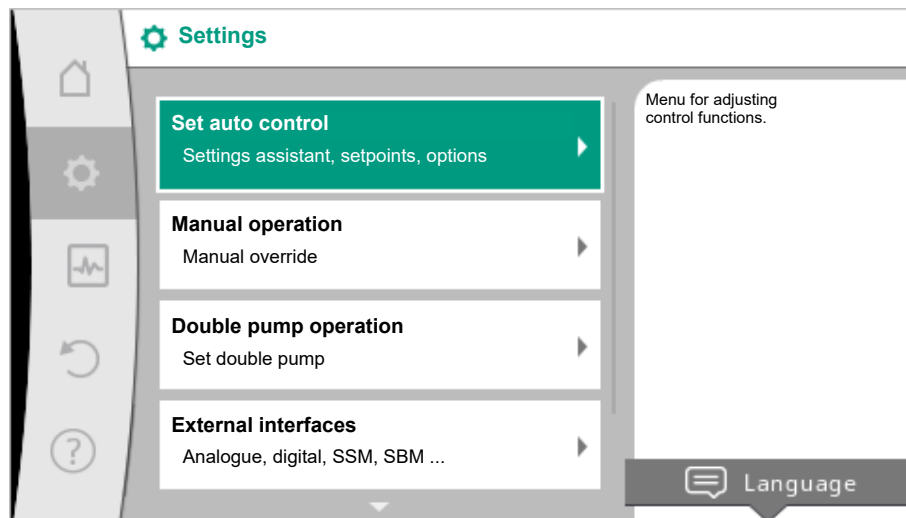



Fig. 15: Settings menu

#### Selection via the application

In the "Settings" menu , select

1. "Set control mode"
2. "Setting assistant" in sequence.

Possible application selection:

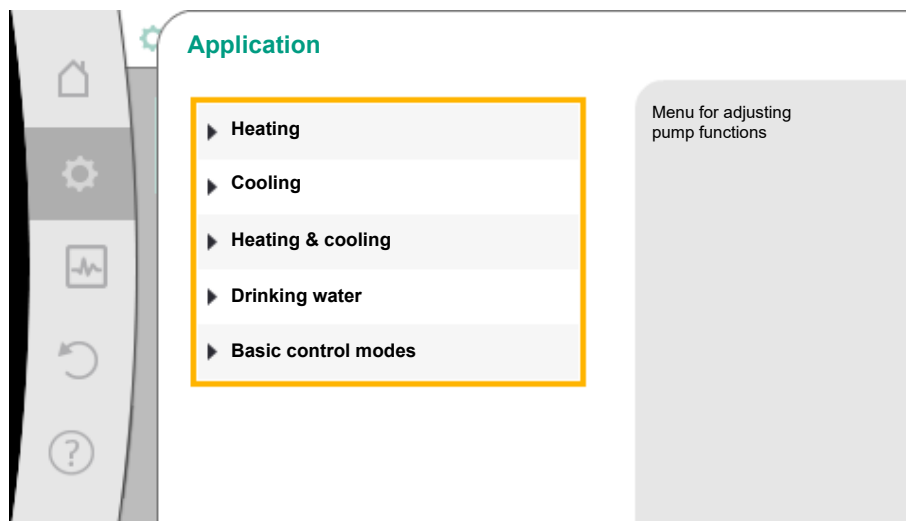

Fig. 16: Application selection

The "Heating" application is used as an **example**.



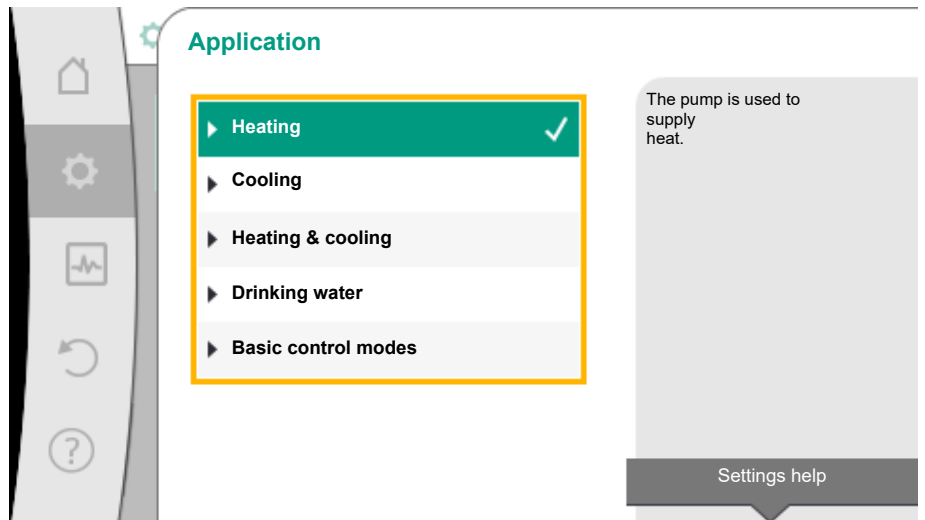

Fig. 17: Example – “Heating” application

Select the “Heating” application by turning the control knob and press to confirm.

Different system types are available depending on the applications.

The following system types are available for the “Heating” application:

#### System types for heating application

- ▶ Radiator
- ▶ Underfloor heating
- ▶ Ceiling heating
- ▶ Fan heater
- ▶ Concrete core heating\*
- ▶ Hydraulic shunt
- ▶ Differential pressure-less distributor\*
- ▶ Buffer heating\*
- ▶ Heat exchanger
- ▶ Heat source circuit (heat pump)\*
- ▶ District heating circuit\*
- ▶ Basic control modes

\*System type from SW > 01.05.10.00 available

The “**Radiator**” system type is used as an **example**.

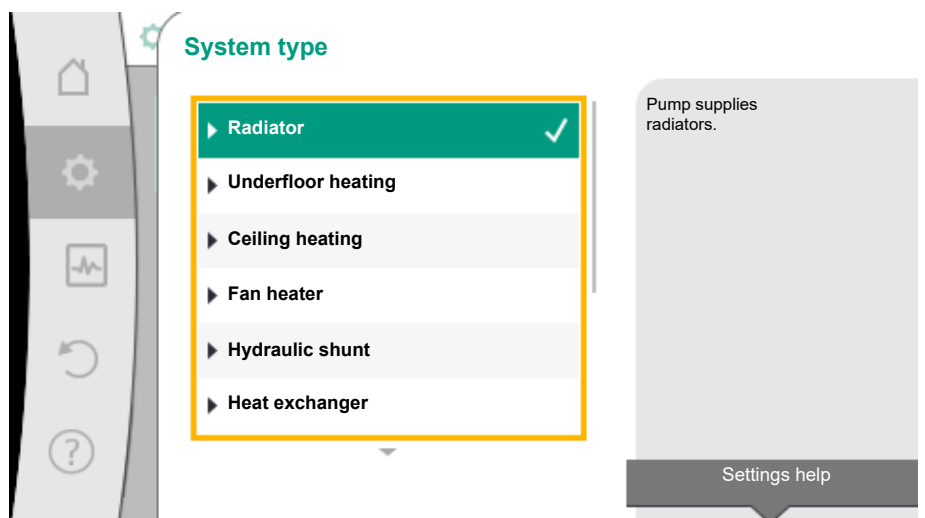

Fig. 18: Example – “Radiator” system type

Select the “Radiator” system type by turning the control knob and press to confirm.

Different control modes are available depending on the system type.

For the “Radiator” system type in the “Heating” application, the following control modes are available:

Control mode
▸ Differential pressure $\Delta p-v$
▸ Dynamic Adapt plus
▸ Hall temperature T-const

Table 6: Selection of control mode for radiator system type in the heating application

#### Example: Control mode “Dynamic Adapt plus”

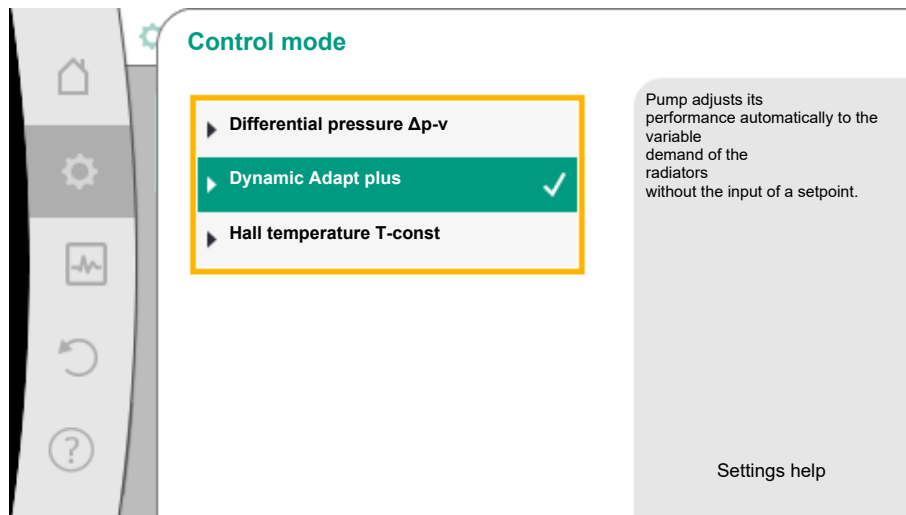

Fig. 19: Example – “Dynamic Adapt plus” control mode

Turn the control knob to select “Dynamic Adapt plus” control mode. Press the control knob to confirm.

No other settings are required in Dynamic Adapt plus.

Once you have confirmed the selection, it is displayed in the “Setting assistant” menu.

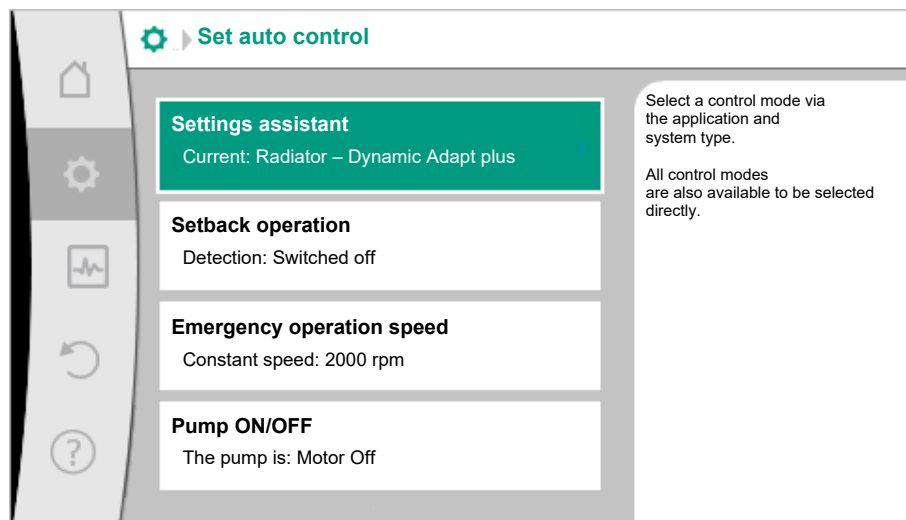



Fig. 20: Setting assistant

#### Direct selection of a basic control mode

In the “Settings” menu , select

1. “Set control mode”
2. “Setting assistant”
3. “Basic control modes” in sequence.

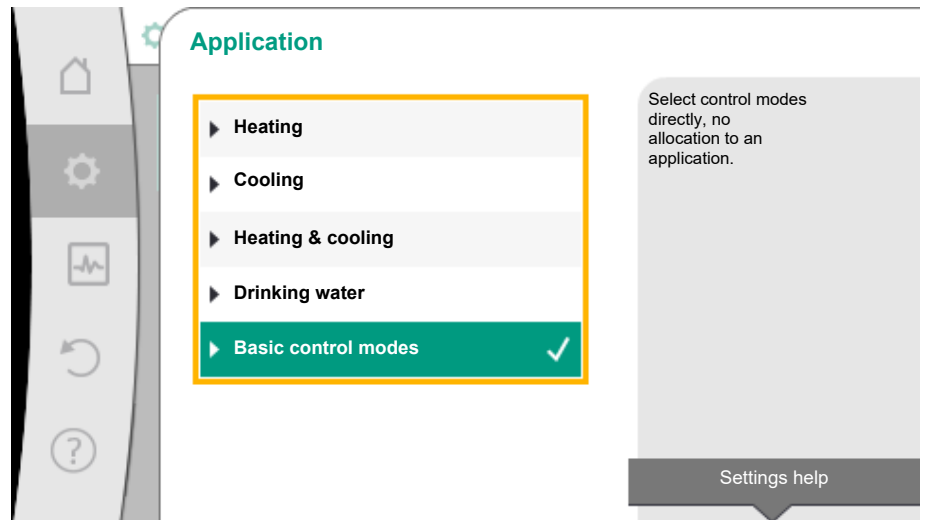

Fig. 21: Application selection “Basic control modes”

The following basic control modes are available:

#### Basic control modes

- ▶ Differential pressure  $\Delta p-v$
- ▶ Differential pressure  $\Delta p-c$
- ▶ Index circuit  $\Delta p-c$
- ▶ Dynamic Adapt plus
- ▶ Volume flow  $Q-const$
- ▶ Multi-Flow Adaptation
- ▶ Temperature  $T-const.$
- ▶ Temperature  $\Delta T-const$
- ▶ Speed  $n-const$
- ▶ PID control

Table 7: Basic control modes

A control mode with temperature control, index circuit  $\Delta p-c$  control and the PID control also requires the selection of actual value or sensor source (analogue input AI1/AI2, internal sensor).

When you confirm a selected basic control mode, the “Setting assistant” sub-menu appears, displaying the selected control mode in the information bar.

You see more menus under this display. These are intended for parameter configuration. For example: Input of the setpoint for differential pressure control, activation/deactivation of night setback, No-Flow Stop function or input emergency operation speed.

#### Heating & cooling application

The “Heating & cooling” application combines both the applications. The pump is set separately for both applications and can switch between both applications.

In the “Settings” menu , select

1. “Set control mode”
2. “Setting assistant”
3. “Heating & cooling” in sequence.

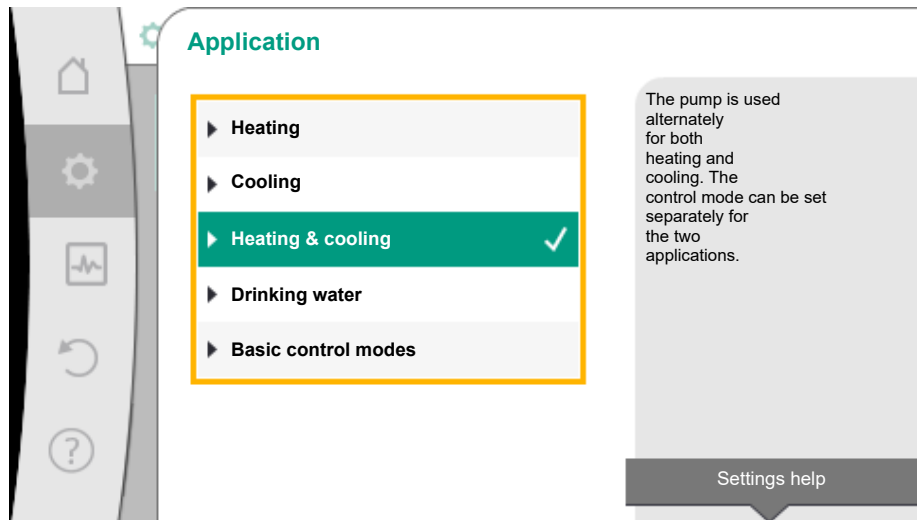

Fig. 22: “Heating & cooling” application selection

Select the control mode for the “Heating” application first.

System types for heating application	Control mode
<ul style="list-style-type: none"> <li>▸ Radiator</li> </ul>	Differential pressure $\Delta p-v$ Dynamic Adapt plus Hall temperature T-const.
<ul style="list-style-type: none"> <li>▸ Underfloor heating</li> <li>▸ Ceiling heating</li> </ul>	Differential pressure $\Delta p-c$ Dynamic Adapt plus Hall temperature T-const.
<ul style="list-style-type: none"> <li>▸ Fan heater</li> </ul>	Differential pressure $\Delta p-v$ Dynamic Adapt plus Hall temperature T-const.
<ul style="list-style-type: none"> <li>▸ Concrete core heating*</li> </ul>	Differential pressure $\Delta p-c$ Dynamic Adapt plus Feed/return $\Delta T$ Volume flow $cQ$
<ul style="list-style-type: none"> <li>▸ Hydraulic shunt</li> </ul>	Sec. feed temperature T-const. Return $\Delta T$ Multi-Flow Adaptation Volume flow $cQ$
<ul style="list-style-type: none"> <li>▸ Differential pressure-less distributor*</li> <li>▸ Buffer heating*</li> </ul>	Multi-Flow Adaptation Volume flow $cQ$
<ul style="list-style-type: none"> <li>▸ Heat exchanger</li> </ul>	Sec. feed temperature T-const. Feed $\Delta T$ Multi-Flow Adaptation Volume flow $cQ$
<ul style="list-style-type: none"> <li>▸ Heat source circuit* (heat pump)</li> </ul>	Feed/return $\Delta T$ Volume flow $cQ$
<ul style="list-style-type: none"> <li>▸ District heating circuit*</li> </ul>	Differential pressure $\Delta p-c$ Differential pressure $\Delta p-v$ Index circuit $\Delta p-c$

System types for heating application	Control mode
▸ Basic control modes	Differential pressure $\Delta p-c$ Differential pressure $\Delta p-v$ Index circuit $\Delta p-c$ Dynamic Adapt plus Volume flow $cQ$ Temperature $T$ -const Temperature $\Delta T$ -const. Speed $n$ -const.

Table 8: Selection system type and control mode for "Heating" application

\*System type from SW > 01.05.10.00 available

After having selected the desired system type and control mode for the "Heating" application, select the control mode for the "Cooling" application.

System types for cooling application	Control mode
▸ Ceiling cooling	Differential pressure $\Delta p-c$
▸ Underfloor cooling	Dynamic Adapt plus Hall temperature $T$ -const.
▸ Air-conditioning device	Differential pressure $\Delta p-v$ Dynamic Adapt plus Hall temperature $T$ -const.
▸ Concrete core cooling*	Differential pressure $\Delta p-c$ Dynamic Adapt plus Feed/return $\Delta T$ Volume flow $cQ$
▸ Hydraulic shunt	Feed temperature $T$ -const. Return $\Delta T$
▸ Differential pressure-less distributor*	Multi-Flow Adaptation
▸ Buffer cooling*	Volume flow $cQ$
▸ Heat exchanger	Feed temperature $T$ -const Feed $\Delta T$
▸ Re-cooling circuit*	Volume flow $cQ$
▸ District cooling circuit*	Differential pressure $\Delta p-c$ Differential pressure $\Delta p-v$ Index circuit $\Delta p-c$
▸ Basic control modes	Differential pressure $\Delta p-c$ Differential pressure $\Delta p-v$ Index circuit $\Delta p-c$ Dynamic Adapt plus Volume flow $cQ$ Temperature $T$ -const Temperature $\Delta T$ -const. Speed $n$ -const.

Table 9: Selection of system type and control mode for "Cooling" application

\*System type from SW > 01.05.10.00 available

Every control mode, with the exception of speed  $n$ -const., additionally requires the selection of the actual value or sensor source (analogue input AI1 to AI2).



## NOTICE

Control mode temperature  $\Delta T$ -const.

In the pre-defined applications, the signs and setting ranges for the set-point temperature ( $\Delta T$ -const.) are pre-set to match the application and thus the effect on the pump (increase or reduction in speed) is pre-set. When setting via "Basic control mode", the sign and setting range must be configured according to the desired effect.

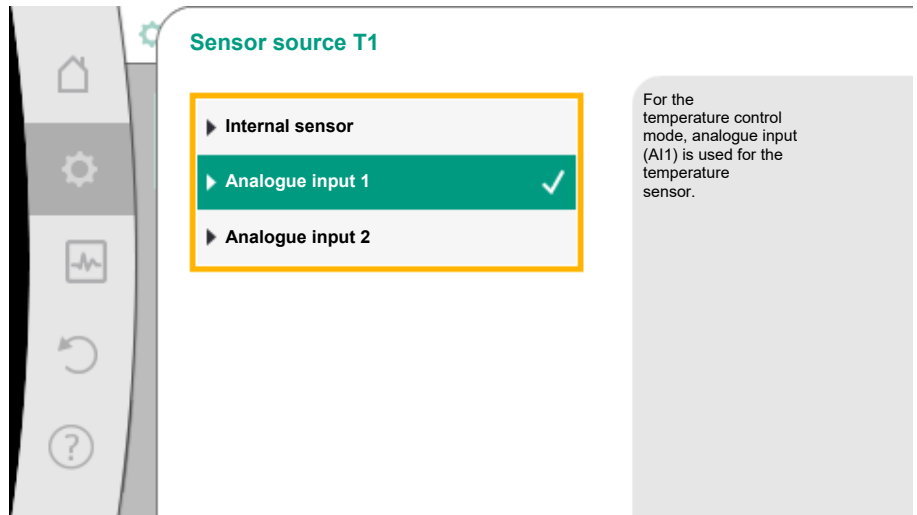

Fig. 23: Assignment of sensor source

If the selection is made, the sub-menu "Setting assistant" will appear with the display of selected system type and control mode.



## NOTICE

The menu "Heating/cooling switchover" for further adjustments is available only if all settings have been made for "Heating & Cooling" application.

### Heating/cooling switchover

If the pump is installed in a circuit used for both heating and cooling, the pump can be switched to heating or cooling depending on the application. This can be done either manually, automatically through detection of the feed temperature or by an external binary contact through a building automation data point.

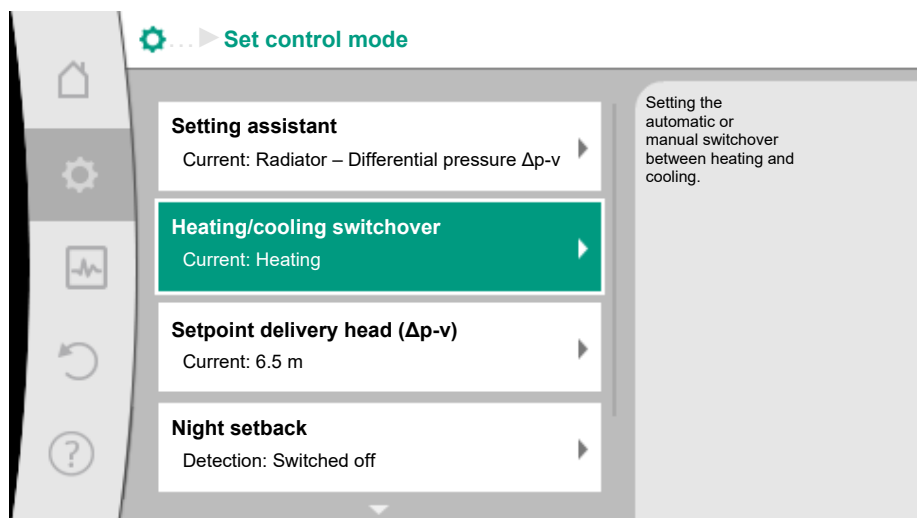

Fig. 24: Heating/cooling switchover

Initially select "Heating" in the "Set control mode" – "Heating/cooling switchover" menu. Then configure additional settings (e.g. setpoint specification, night setback, etc.) in the "Set control mode" menu.

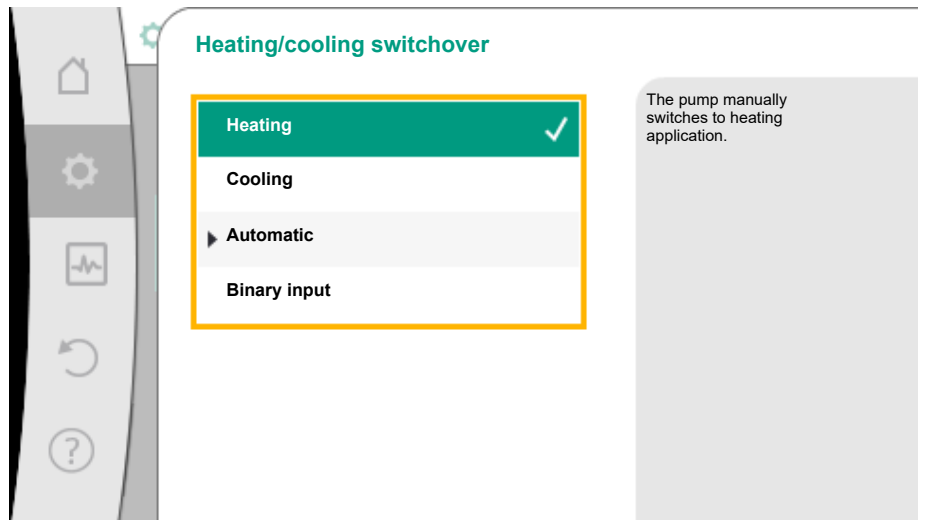

Fig. 25: Heating/cooling switchover\_“Heating”

The settings for cooling are made once the specifications for heating are completed. To do this, select “Cooling” in the “Heating/cooling switchover” menu.

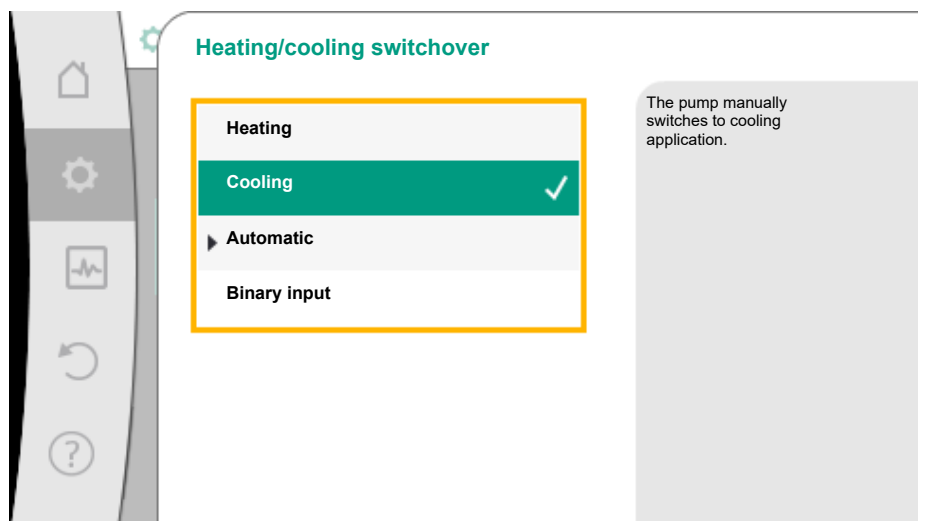

Fig. 26: Heating/cooling switchover\_“Cooling”

More settings (e.g. setpoint,  $Q\text{-Limit}_{\text{Max}}$ ,...) can be made in the “Set control mode” menu. In order to adjust the automatic switchover between heating and cooling, select “Automatic” and enter the switchover temperature each for heating and cooling.

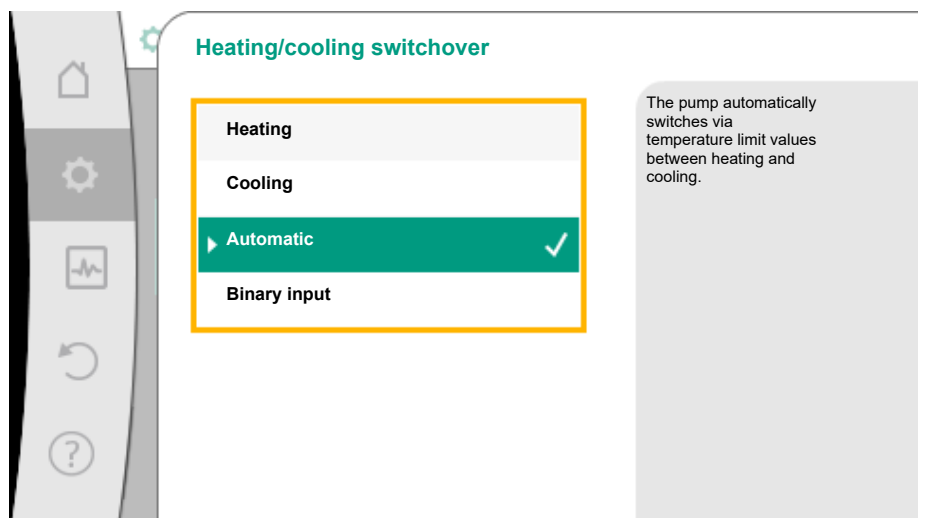

Fig. 27: Heating/cooling switchover\_“Automatic”

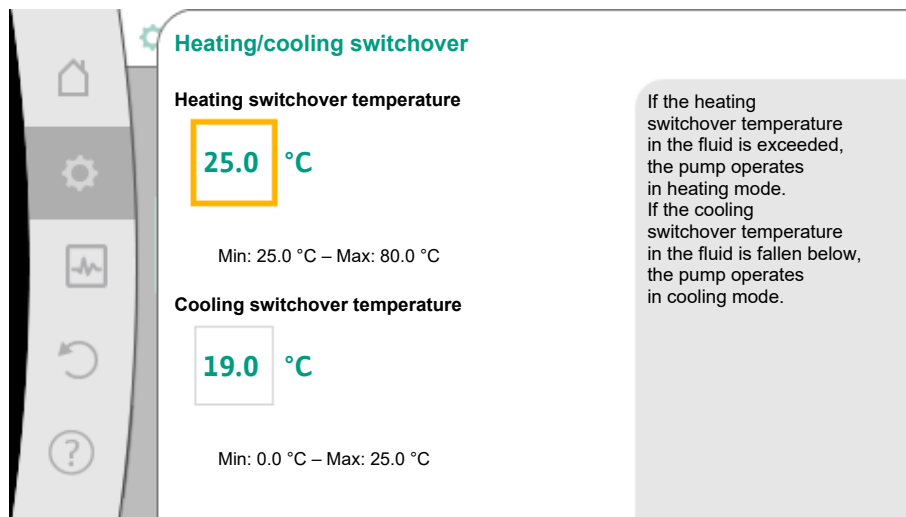

Fig. 28: Heating/cooling switchover\_“Switchover temperatures”

If the switchover temperatures are exceeded or not reached, the pump automatically switches between heating and cooling.



## NOTICE

If the switchover temperature for heating in the fluid is exceeded, the pump operates in heating mode. If the fluid temperature drops below the cooling switchover temperature, the pump operates in cooling mode.

Once the set switchover temperatures have been reached, the pump initially switches to “Standby” for 15 minutes and then runs in the other mode.

In the temperature range between the two switchover temperatures, the pump remains inactive. It conveys the fluid occasionally only for measuring the temperature.

To prevent inactivity, set the switchover temperatures for heating and cooling to the same temperature. Additionally select the switchover method using a binary input.

For an external switchover between “Heating/cooling”, select “Binary input” in the “Heating/cooling switchover” menu.

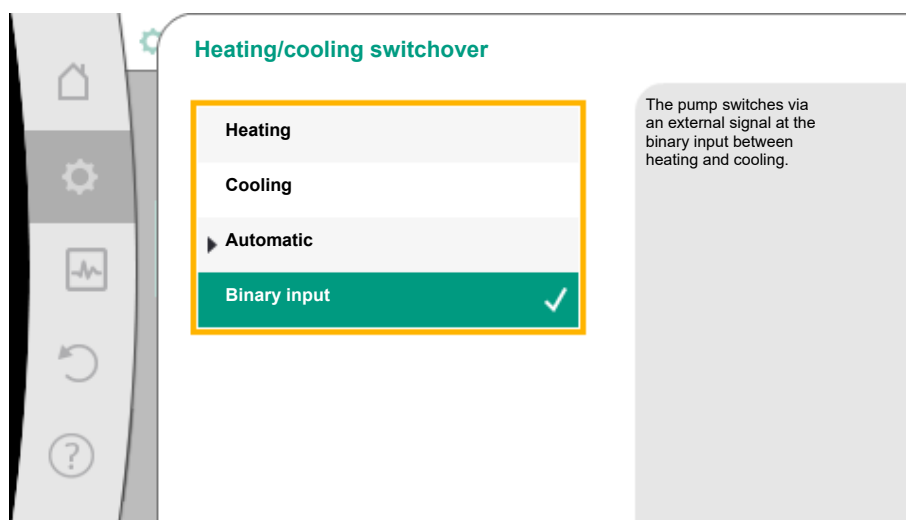

Fig. 29: Heating/cooling switchover\_“Binary input”

The binary input must be set to “Switching heating/cooling” function.





## NOTICE

When using the heating/cooling quantity measurement, the energy is automatically logged in the respective correct counter for heat and cooling energy meter.

### 4.2 Pre-defined applications in the setting assistant

The following applications can be selected via the setting assistant:

Pre-defined system types with control modes and optional additional control functions in the setting assistant

#### Heating application

System type/control mode	Night setback	No-Flow Stop	Q-Limit <sub>Max</sub>	Q-Limit <sub>Min</sub>	Multi-Flow Adaptation Mixer
<b>Radiator</b>					
Differential pressure $\Delta p-v$	X	X	X		
Dynamic Adapt plus	X				
Hall temperature T-const.	X		X		
<b>Underfloor heating</b>					
Differential pressure $\Delta p-c$	X	X	X		
Dynamic Adapt plus	X				
Hall temperature T-const.	X		X		
<b>Ceiling heating</b>					
Differential pressure $\Delta p-c$	X	X	X		
Dynamic Adapt plus	X				
Hall temperature T-const.	X		X		
<b>Fan heater</b>					
Differential pressure $\Delta p-v$	X	X	X		
Dynamic Adapt plus	X				
Hall temperature T-const.	X		X		
<b>Concrete core heating</b>					
Differential pressure $\Delta p-c$	X	X	X		
Dynamic Adapt plus	X				
Feed/return $\Delta T$	X		X	X	
Volume flow Q-const.	X				
<b>Hydraulic shunt</b>					
Sec. feed temperature T-const.	X		X		
Return $\Delta-T$	X		x	●	
Multi-Flow Adaptation				X	X
Volume flow Q-const.	X				
<b>Differential pressure-less distributor</b>					
Multi-Flow Adaptation				X	X
Volume flow Q-const.	X				
<b>Buffer heating</b>					
Multi-Flow Adaptation				X	X
Volume flow Q-const.	X				
<b>Heat exchanger</b>					
Sec. feed temperature T-const.	X		X		
Feed $\Delta-T$	X		x	●	
Multi-Flow Adaptation				X	X
Volume flow Q-const.	X				

System type/control mode	Night setback	No-Flow Stop	Q-Limit <sub>Max</sub>	Q-Limit <sub>Min</sub>	Multi-Flow Adaptation Mixer
<b>Heat source circuit heat pump</b>					
Feed/return $\Delta T$	X		X	X	
Volume flow Q-const.	X				
<b>District heating circuit</b>					
Differential pressure $\Delta p-c$	X	X	X		
Differential pressure $\Delta p-v$	X	X	X		
Index circuit $\Delta p-c$	X		X	X	
<b>Basic control modes</b>					
Differential pressure $\Delta p-c$	X	X	X	X	
Differential pressure $\Delta p-v$	X	X	X	X	
Index circuit $\Delta p-c$	X	X	X	X	
Dynamic Adapt plus	X				
Volume flow Q-const.	X				
Multi-Flow Adaptation				X	X
Temperature T-const.	x	X	X	X	
Temperature $\Delta T$ -const.	X	X	X	X	
Speed n-const.	X	X	X	x	

●: permanently activated additional control function

x: available additional control function for the control mode

Table 10: Heating application

Pre-defined system types with control modes and optional additional control functions in the setting assistant

#### Cooling application

System type/control mode	Night setback	No-Flow Stop	Q-Limit <sub>Max</sub>	Q-Limit <sub>Min</sub>	Multi-Flow Adaptation Mixer
<b>Ceiling cooling</b>					
Differential pressure $\Delta p-c$		X	X		
Dynamic Adapt plus					
Hall temperature T-const.			X		
<b>Underfloor cooling</b>					
Differential pressure $\Delta p-c$		X	X		
Dynamic Adapt plus					
Hall temperature T-const.			X		
<b>Air-conditioning device</b>					
Differential pressure $\Delta p-v$		X	X		
Dynamic Adapt plus	X				
Hall temperature T-const.			X		
<b>Concrete core cooling</b>					
Differential pressure $\Delta p-c$		X	X		
Dynamic Adapt plus					
Feed/return $\Delta T$			X	X	
Volume flow Q-const.					
<b>Hydraulic shunt</b>					
Sec. feed temperature T-const.			X		
Return $\Delta T$			x	●	
Multi-Flow Adaptation				X	X

System type/control mode	Night setback	No-Flow Stop	Q-Limit <sub>Max</sub>	Q-Limit <sub>Min</sub>	Multi-Flow Adaptation Mixer
Volume flow Q-const.					
<b>Differential pressure-less distributor</b>					
Multi-Flow Adaptation				X	X
Volume flow Q-const.					
<b>Buffer cooling</b>					
Multi-Flow Adaptation				X	X
Volume flow Q-const.					
<b>Heat exchanger</b>					
Sec. feed temperature T-const.			X		
Feed $\Delta$ -T			x	●	
Multi-Flow Adaptation				X	X
Volume flow Q-const.					
<b>Re-cooling circuit</b>					
Volume flow Q-const.					
<b>District cooling circuit</b>					
Differential pressure $\Delta$ p-c		X	X		
Differential pressure $\Delta$ p-v		X	X		
Index circuit $\Delta$ p-c			X	X	
<b>Basic control modes</b>					
Differential pressure $\Delta$ p-c		X	X	X	
Differential pressure $\Delta$ p-v		X	X	X	
Index circuit $\Delta$ p-c		X	X	X	
Dynamic Adapt plus					
Volume flow Q-const.					
Multi-Flow Adaptation				X	X
Temperature T-const.		x	X	X	
Temperature $\Delta$ T-const.		X	X	X	
Speed n-const.		X	X	x	

●: permanently activated additional control function

x: available additional control function for the control mode

Table 11: Cooling application

Pre-defined system types with control modes and optional additional control functions in the setting assistant

#### Drinking water application

System type/control mode	Night setback	No-Flow Stop	Q-Limit <sub>Max</sub>	Q-Limit <sub>Min</sub>	Detection of disinfection
<b>Drinking water (circulation)</b>					
Temperature T-const.			x	X	X
<b>Drinking water storage tank</b>					
Charge pump			X	X	
<b>Basic control modes</b>					
Differential pressure $\Delta$ p-c	X	X	X	X	
Differential pressure $\Delta$ p-v	X	X	X	X	
Index circuit $\Delta$ p-c	X	X	X	X	
Dynamic Adapt plus	X				
Volume flow Q-const.					
Multi-Flow Adaptation				X	

System type/control mode	Night setback	No-Flow Stop	Q-Limit <sub>Max</sub>	Q-Limit <sub>Min</sub>	Detection of disinfection
Temperature T-const.	x	X	X	X	
Temperature ΔT-const.	X	X	X	X	
Speed n-const.	X	X	X	x	

●: permanently activated additional control function

x: available additional control function for the control mode

Table 12: Drinking water application



## NOTICE

The additional control functions No-Flow Stop und Q-Limit<sub>Min</sub> cannot be active simultaneously.

### 4.3 Settings menu – Set auto control

The “Set control mode” menu described below only provides the menu items for selection that can also be used in the currently selected control function.

For this reason, the list of potential menu items may be much longer than the number of displayed menu items at any one time.

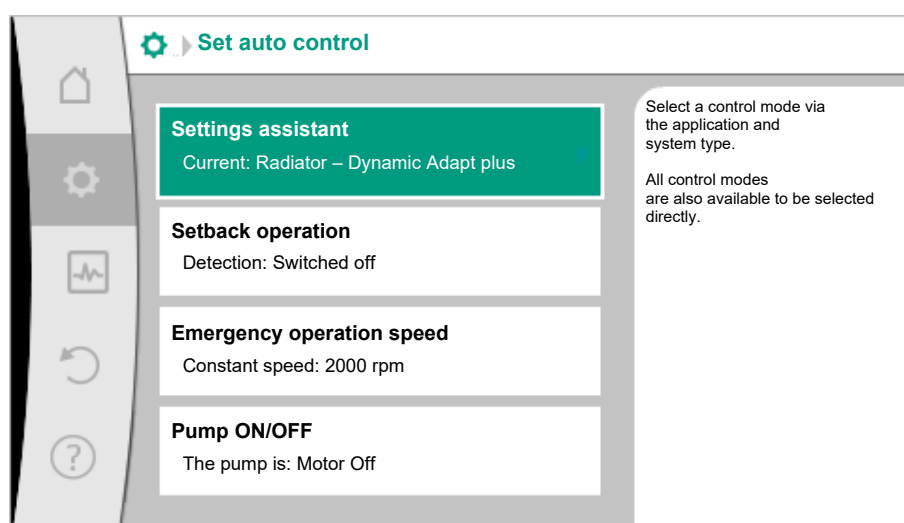

Fig. 30: Set control mode

Settings menu	Description
Setting assistant	Setting the control mode via application and system type.
Heating/cooling switchover Only visible if “Heating & Cooling” has been selected in the setting assistant.	Adjust the automatic or manual switchover between heating and cooling. When selecting “Heating/cooling switchover” in the setting assistant you must enter when the pump operates in the corresponding mode. In addition to a manual selection of “Heating or cooling”, options “Automatic” or “Switchover through a binary input” are also available.  Automatic: Fluid temperatures are requested as decision-making criteria for the switchover after heating or cooling. Binary input: An external binary signal for controlling of “Heating and cooling” is queried.
Heating/cooling temperature sensor Only visible if automatic switchover is selected in setting assistant “Heating & Cooling” and “Heating/cooling switchover”.	Setting the temperature sensor for automatic switchover between heating and cooling.
Delivery head setpoint Visible for active control modes, which require a delivery head as setpoint.	Setting the setpoint of the delivery head $H_5$ for the control mode.

Settings menu	Description
Setpoint volume flow (Q-const) Visible for active control modes, which require a volume flow as setpoint.	Setting the volume flow setpoint for the control mode "Volume flow Q-const"
Feeder pump correction factor Visible for Multi-Flow Adaptation, which offers a correction value.	Correction factor for the volume flow of the feeder pump in the control mode "Multi-Flow Adaptation". The setting range differs depending on the system type in the applications. Can be used for a supplement to the total volume flow from the secondary pumps for additional protection against inadequate supply.
Selection of secondary pumps Visible for Multi-Flow Adaptation.	Selecting of secondary pumps which are used for measuring the volume flow in Multi-Flow Adaptation.
Multi-Flow Adaptation Overview Visible for Multi-Flow Adaptation.	Overview of the number of connected secondary pumps and their requirements.
Volume flow offset Visible for Multi-Flow Adaptation.	Pumps without Wilo Net communication can be supplied with an adjustable offset volume flow in the Multi-Flow Adaptation system.
Multi-Flow Adaptation mixer Visible for Multi-Flow Adaptation.	In the case of secondary pumps in circuits with mixers, the mixed volume flow can be determined and therefore the actual demand can be ascertained.
Substitute value volume flow Visible for Multi-Flow Adaptation.	Setting of the substitute value for the volume flow requirement for the primary pump if the connection to the secondary pumps is interrupted.
Setpoint temperature (T-const) Visible for active control modes, which require an absolute temperature as setpoint.	Setting the setpoint of the temperature for the control mode "Constant Temperature (T-const)".
Setpoint temperature ( $\Delta T$ -const.) Visible for active control modes, which require an absolute temperature difference as setpoint.	Setting the setpoint of the temperature difference for the control mode "Constant Temperature Difference ( $\Delta T$ -const.)".
Setpoint speed Visible for active control modes, which require speed as setpoint.	Setting the setpoint of the speed for the control mode "Constant Speed (n-const.)".
Setpoint PID Visible for user-defined control.	Setting the setpoint of the user-defined control via PID.
External setpoint source Visible if an external setpoint source (analogue input or CIF module) was selected previously in the context menu.	Linking the setpoint to an external setpoint source and setting the setpoint source.
Temperature sensor T1 Visible for active control modes, which require a temperature sensor as actual value (constant temperature).	Setting first sensor (1), which is used for temperature control (T-const., $\Delta T$ -const.).
Temperature sensor T2 Visible for active control modes, which require a second temperature sensor as actual value (difference temperature control).	Setting the second sensor (2, $\Delta T$ -const) used for temperature control.
Free sensor input Visible for user-defined control.	Setting the sensor for user-defined PID control.
External delivery head sensor Visible for index circuit evaluator $\Delta p$ -c, which requires a differential pressure as actual value.	Setting the external sensor for the delivery head with index circuit evaluator.
Night setback Visible for active control modes, which support additional control function "automatic night setback". (see "Pre-defined applications in the setting assistant" [► 33] table)	Setting automatic detection of night setback.

Settings menu	Description
<b>No-Flow Stop</b> Visible for active control modes, which support the additional function “No-Flow Stop”. (see “Pre-defined applications in the setting assistant” [► 33] table).	Setting automatic detection of closed valves (no flow).
<b>Q-Limit<sub>Max</sub></b> Visible for active control modes, which support additional control function “Q-Limit <sub>Max</sub> ”. (see “Pre-defined applications in the setting assistant” [► 33] table).	Setting an upper threshold of the volume flow.
<b>Q-Limit<sub>Min</sub></b> Visible for active control modes, which support the additional control function “Q-Limit <sub>Min</sub> ”. (see “Pre-defined applications in the setting assistant” [► 33] table).	Setting a lower threshold of the volume flow.
<b>Detection of disinfection</b> Visible for active control modes, which support the additional control function “Detection of disinfection”. (see “Pre-defined applications in the setting assistant” [► 33] table).	
<b>Emergency operation speed</b> Visible for active control modes that reset to a fixed speed.	The pump automatically switches to this constant speed if the set control mode fails (e.g. sensor signal fault).
<b>PID parameter Kp</b> Visible for user-defined PID control.	Setting the Kp factor for the user-defined PID control.
<b>PID parameter: Ki</b> Visible for user-defined PID control.	Setting the Ki factor for the user-defined PID control.
<b>PID parameter Kd</b> Visible for user-defined PID control.	Setting the Kd factor for the user-defined PID control.
<b>PID: Inversion</b> Visible for user-defined PID control.	Setting the inversion for the user-defined PID control.
<b>Pump On/Off</b> Always visible.	Switching the pump on/off with low priority. A MAX, MIN, MANUAL override switches the pump on.

Table 13: Settings menu – Set control mode

#### 4.4 Adjustment – Manual operation

All control modes, which are selected via the setting assistant, can be overridden with the functions of manual operation OFF, MIN, MAX, MANUAL.



### DANGER

#### The pump can start despite the “OFF” function

The “OFF” function is not a safety function and is no replacement for disconnecting the power supply for maintenance work. Functions such as pump kick can start up the pump despite the “OFF” function being set.

- Always disconnect the pump from the power supply before carrying out any work!

Manual operation functions can be selected in the menu  “Settings” → “Manual operation”

“Manual operation (OFF, MIN, MAX, MANUAL)”

Function	Description
Control mode	Pump works according to the set controls.
OFF	Pump is switched off. Pump is not running. All other set controls will be overridden.
MIN	The pump is set to minimum power. All other set controls are overridden.

Function	Description
MAX	The pump is set to maximum power. All other set controls are overridden.
MANUAL	Pump is working according to set control, which is meant for the "MANUAL" function.

Table 14: Functions of manual operation

The manual operation functions OFF, MAX, MIN, MANUAL correspond to the functions Ext. OFF, Ext. MAX, Ext. MIN and Ext. MANUAL in their effect.

Ext. OFF, Ext. MAX, Ext. MIN and Ext. MANUAL can be triggered via the digital inputs or via a bus system.

#### Priorities

Priority*	Function
1	OFF, External OFF (binary input), External OFF (bus system)
2	MAX, External MAX (binary input), External MAX (bus system)
3	MIN, External MIN (binary input), External MIN (bus system)
4	MANUAL, External MANUAL (binary input)

Table 15: Priorities

\* Priority 1 = highest priority



#### NOTICE

The "MANUAL" function replaces all functions including those which are controlled via a bus system.

If a monitored bus communication fails, the control mode set via the "MANUAL" function is activated (Bus Command Timer).

#### Adjustable control modes for the MANUAL function:

Control mode
MANUAL – Differential pressure $\Delta p-v$
MANUAL – Differential pressure $\Delta p-c$
MANUAL – Volume flow $Q-const$
MANUAL – Speed $n-const$

Table 16: Control modes MANUAL function

## 4.5 Setting up Multi-Flow Adaptation

### 4.5.1 Step 1 – Wilo Net, termination, addressing

To set up Multi-Flow Adaptation, the electrical wiring must first be established via the "Wilo Net" interface between the feeder pump and the secondary pump(s). Wilo Net is a Wilo system bus used for establishing communication between Wilo products. In order to establish the Wilo Net connection, the three H, L, GND terminals must be wired with a communication cable from pump to pump.

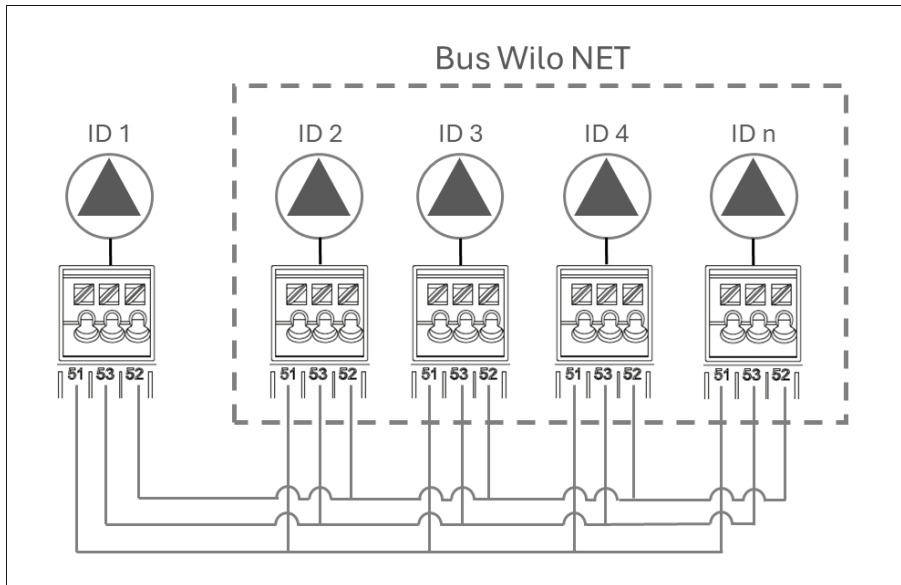

Fig. 31: Bus Wilo Net wiring

Use shielded cables for cable lengths  $\geq 2$  m. Incoming and outgoing cables are clamped in a terminal. Incoming and outgoing cables must be fitted with double-wire end sleeves. To ensure interference immunity in industrial environments (IEC 61000-6-2), use a shielded CAN bus cable and an EMC-compatible cable entry for the Wilo Net cables. Connect the shield to earth at both ends. For optimum transmission, the data cable pair (H and L) must be twisted at Wilo Net and have a characteristic impedance of 120 ohms. Maximum cable length 200 m. Possible cable for Wilo Net communication: CAN-Bus cable 2x2x0.34 mm<sup>2</sup>.

In the Wilo Net, a maximum of 21 participants (from pump software SW 01.04.19.00) can communicate with each other, each individual node counting as a participant here, i.e., a twin-head pump/two-pump system consists of two participants.

**Twin-head pump in the Wilo Net network**

If twin-head pumps are added to a larger Wilo Net network (e.g. Multi-Flow Adaptation), the local Wilo Net twin-head pumps must be adapted to the large system.

As a factory setting, the two pump heads each have ID 1 and ID 2 and termination activated.

For integration into a larger Wilo Net network, deactivate at least one termination, depending on the position in which the twin-head pump is integrated in the Wilo Net segment.

**Changing Wilo Net ID and termination for a generic twin-head pump**

With the operation on pump head I of a twin-head pump (with graphic display), only the Wilo Net ID and termination of this pump head can be changed. In order to be able to assign new Wilo Net IDs to both pump heads of a twin-head pump, the twin-head pump system must first be disbanded and the new ID (e.g. “4”) must be set on pump head I. If necessary, the termination must be deactivated beforehand. Then the graphic display must be changed from pump head I to pump head II in order to adjust the Wilo Net ID (e.g. “5”) there as well.

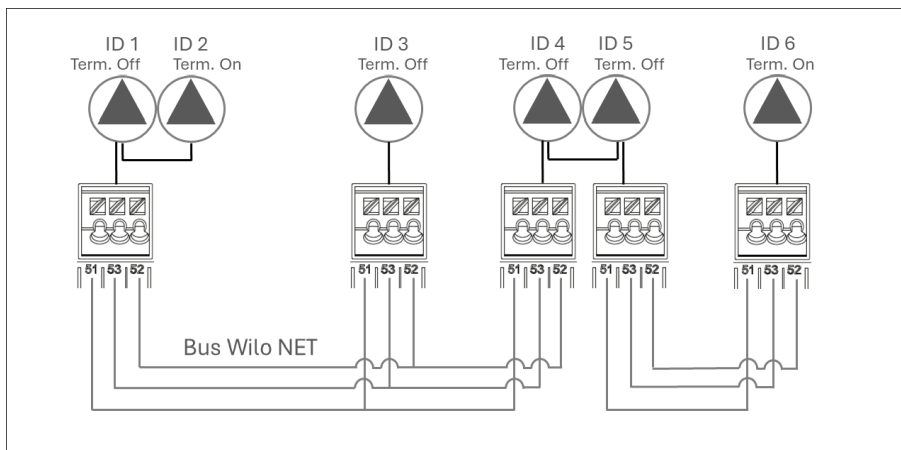



Fig. 32: Bus Wilo Net addressing



In the  “Settings” menu, select the following in sequence:

1. “External interfaces”

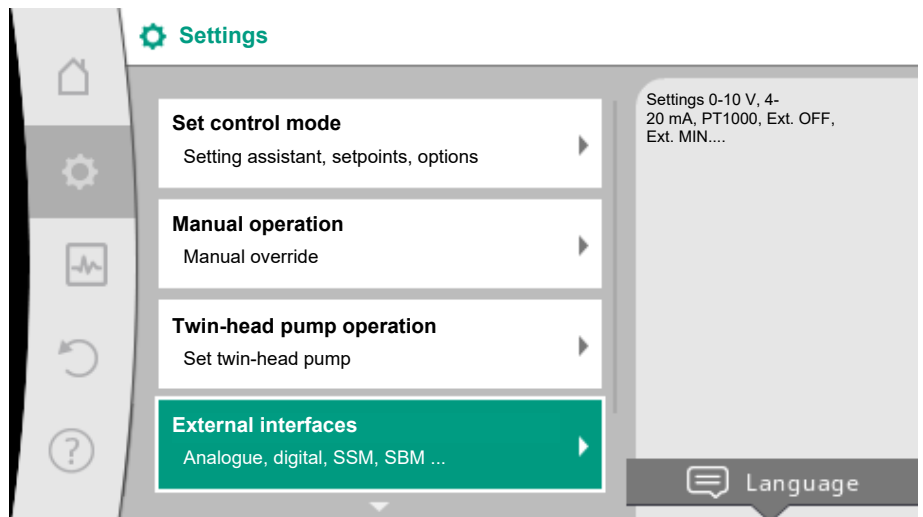

Fig. 33: External interfaces

2. “Wilо Net setting”

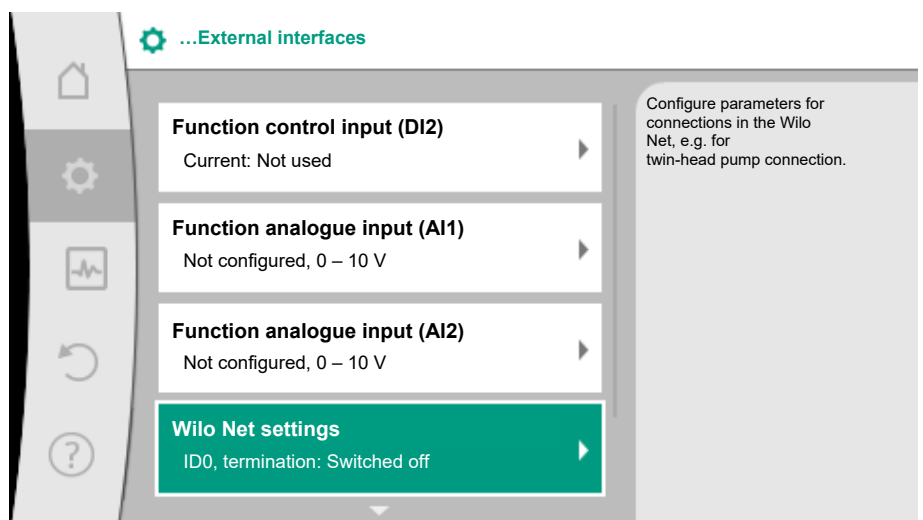
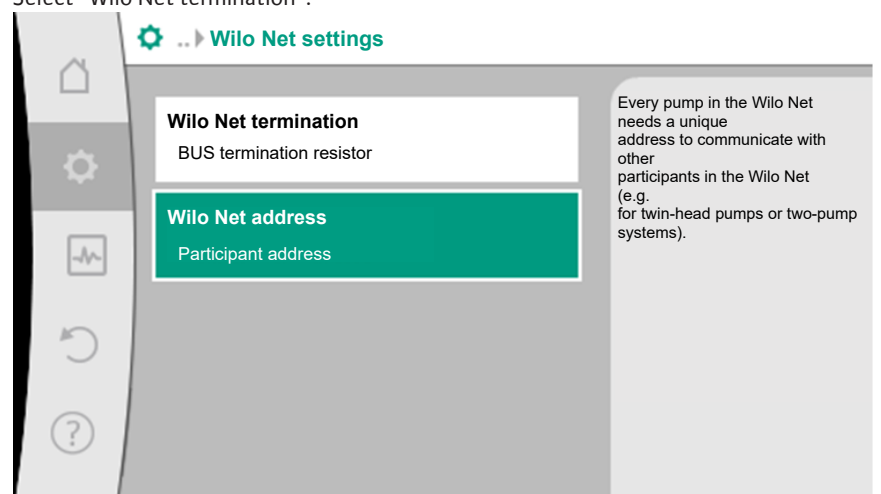

Fig. 34: Wilо Net settings

3. Select “Wilо Net termination”.



The feeder pump and the last wired secondary pump must be selected as “switched on” when selecting the Wilо Net termination.

The other secondary pumps must remain “switched off”.

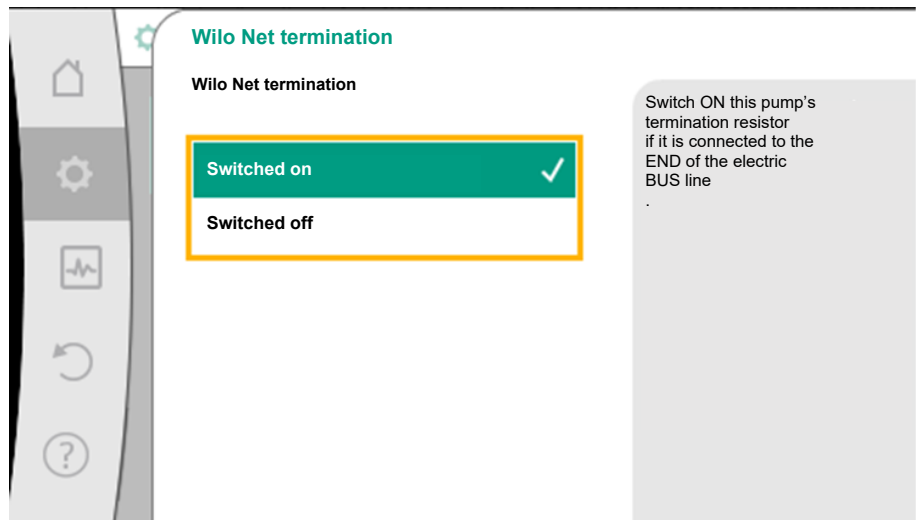

Fig. 35: Wilo Net termination

4. Select “Wilo Net address” and assign each pump its own address (1 to 21).

**Example 1: Multi-Flow Adaptation featuring four pumps:**

- Feeder pump (primary circuit pump)
  - Wilo Net termination: **ON**
  - Wilo Net address: 1
- Secondary pump 1:
  - Wilo Net termination: OFF
  - Wilo Net address: 2
- Secondary pump 2:
  - Wilo Net termination: OFF
  - Wilo Net address: 3
- Secondary pump 3:
  - Wilo Net termination: **ON**
  - Wilo Net address: 4

**Example 2: The primary circuit pump of a Multi-Flow Adaptation system is a twin-head pump:**

- Feeder pump (primary circuit pump)
  - Wilo Net termination: **ON**
  - Wilo Net address: 1
  - Wilo Net address: 2
- Secondary pump 1:
  - Wilo Net termination: OFF
  - Wilo Net address: 3
- Secondary pump n=2 to 18
  - Wilo Net termination: OFF
  - Wilo Net address: 2+n
  - 
  - 
  -
- Secondary pump n=19:
  - Wilo Net termination: **ON**
  - Wilo Net address: 21

In a Multi-Flow Adaptation system with twin-head pumps, a maximum of 5 twin-head pumps can communicate with each other via Wilo Net in the MFA network. In addition to this maximum of 5 twin-head pumps, up to 11 additional single pumps can be included in the network.

After completion of the wiring, termination and addressing, set the pumps according to their application.

**4.5.2 Step 2 – Setting Multi-Flow Adaptation on the primary circuit pump**

After termination and addressing of all pumps, set the control function “Multi-Flow Adaptation” on the primary circuit pump.

This control function can be selected via the menu:

1. ⚙️ “Settings” menu → Set control mode → Setting assistant → **Heating** → Hydraulic shunt or heat exchanger → Multi-Flow Adaptation.
2. ⚙️ “Settings” menu → Set control mode → Setting assistant → **Cooling** → Hydraulic shunt or heat exchanger → Multi-Flow Adaptation.
3. ⚙️ “Settings” menu → Set control mode → Setting assistant → **Heating or cooling** → **Basic control modes** → Multi-Flow Adaptation.
4. ⚙️ “Settings” menu → Set control mode → Setting assistant → **Basic control modes** → Multi-Flow Adaptation.

#### Setting additional control function “Multi-Flow Adaptation mixer”

The additional control function “Multi-Flow Adaptation mixer” is used to calculate the mixed volume flow in secondary loops with integrated 3-way mixers. As a result, the primary circuit pump takes the actual demand of the secondary pumps into account.

The following must be taken into account when installing and setting the pump for the calculation of the required thermal energy or mass flow for the secondary loop: To be able to use the function, the “Multi-Flow Adaptation mixer” function must be activated on the feeder pump and the temperatures must be recorded:

- in the secondary feed downstream of the hydraulic shunt
- in the primary feed upstream of the hydraulic shunt

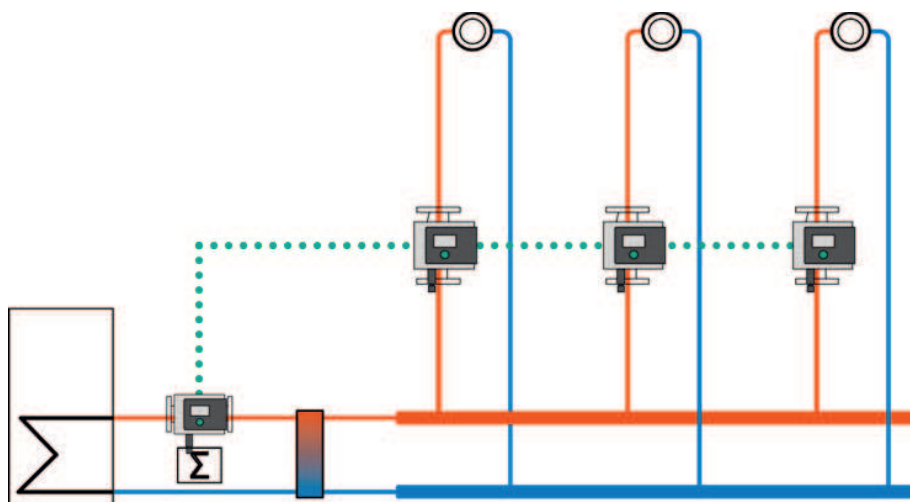

For the secondary feed, connect the temperature sensor to either analogue input AI1 or AI2. The internal temperature sensor can be used for the primary feed.



#### NOTICE

In order to determine the mixed volume flow, the “heat quantity measurement” function with a connected temperature sensor in the secondary feed and secondary return must always be activated on the secondary pumps with mixer.

In the “Set control mode” menu → “Multi-Flow Adaptation mixer”, turn the control knob to select “Switched on” and press to confirm.

The temperature sensors T1 and T2 on the feeder pump must then be configured to the correct sensor input (internal, AI1 or AI2) and the type of use.

In the factory setting, temperature sensor T1 is preset to “Analogue input 1” and temperature sensor T2 is preset to “Internal sensor”. The type of use of the temperature sensor T1 must then be set to the “temperature sensor” and the appropriate “Signal type – Analogue input (AI1)” e.g. PT1000.

After these adjustments, Multi-Flow Adaptation is activated with the additional control function “Multi-Flow Adaptation mixer”.

Temperature sensors must be fitted to the secondary pumps in the feed and return of the secondary loop and connected to the analogue inputs. The type of use must be selected and the setpoint source coupled to the analogue inputs. In addition, the heating or cooling quantity measurement must be activated on the respective pump.

### 4.5.3 Step 3 – Selection of secondary pumps

In order to select the secondary pumps connected to the Wilo Net, select “Selection of secondary pumps” in the menu. The connected secondary pumps are listed there and can be selected.

#### Setting assistant – Selection of secondary pumps

Select secondary pumps that have to be supplied downstream of a hydraulic shunt or heat exchanger and connect them to Wilo Net.

Select “Selection of secondary pumps” by turning the control knob and pressing to confirm. Each partner pump has to be selected as secondary pump from the pumps detected by Wilo Net.

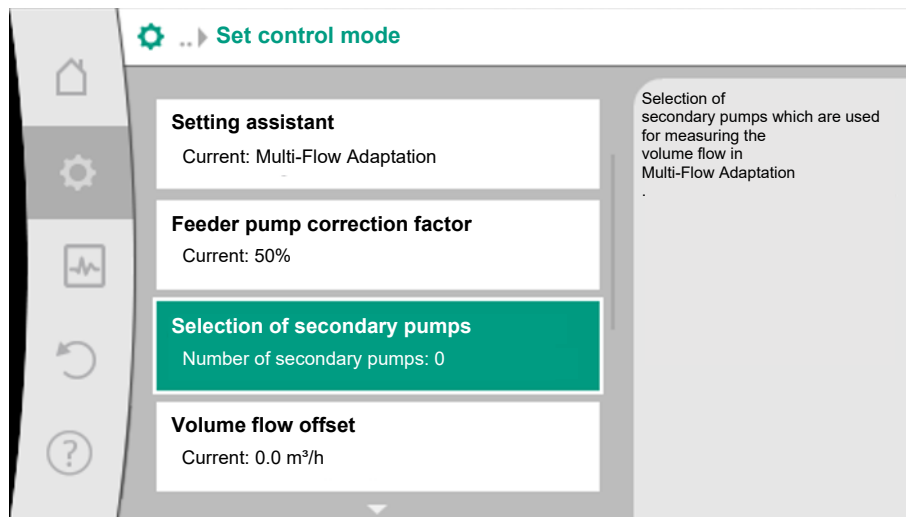

Fig. 36: Selection of secondary pumps for Multi-Flow Adaptation

Select the partner pump by turning the control knob and press to confirm.

When pressed, the white tick appears on the selected pump.

The secondary pump indicates for its part on the display that it has been selected.

All other secondary pumps are selected in the same way. Then press the Back button to go back to the “Set control mode” menu.

To visualise the Multi-Flow Adaptation Overview, “Operating data, statistics” can be selected in the main menu “Diagnostics and measured values”. Then select “Multi-Flow Adaptation Overview”.

### 4.5.4 Step 4 – Setting up secondary pumps

Adjust settings of the pumps in the secondary loops according to the application as set out in the “Setting the control functions [▶ 16]” section.

### 4.5.5 Correction factor setting

A correction factor can be set on the feeder pump. This correction factor provides additional supply security. To adjust the correction factor, the selection “Feeder pump correction factor” can be selected and the correction factor set between 50 and 200%.

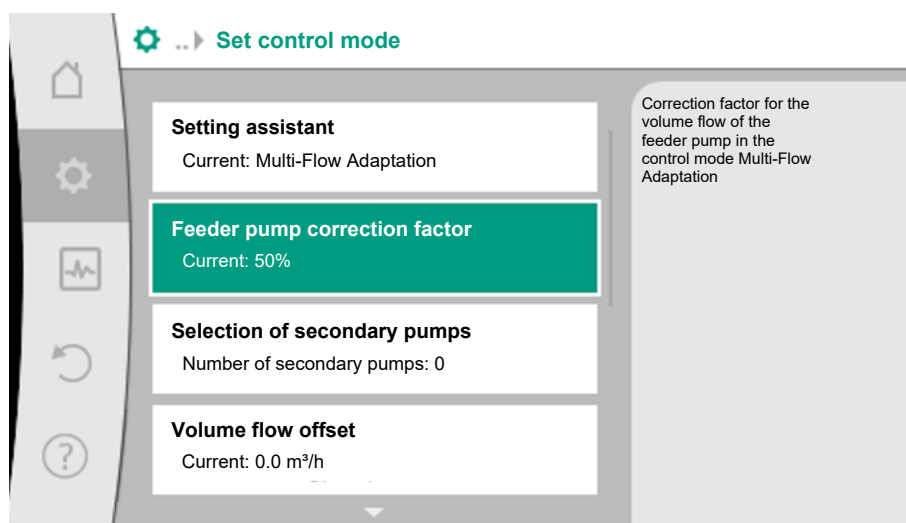

Fig. 37: Setting feeder pump correction factor

### 4.5.6 Setting volume flow offset

If pumps without Wilo-Net are integrated in the secondary loop, the volume flow offset of these pumps can be taken into account on the primary circuit pump. Selection is via:

“Volume flow offset”. The maximum “volume flow offset” value that can be set on the primary circuit pump is different depending on the pump type.

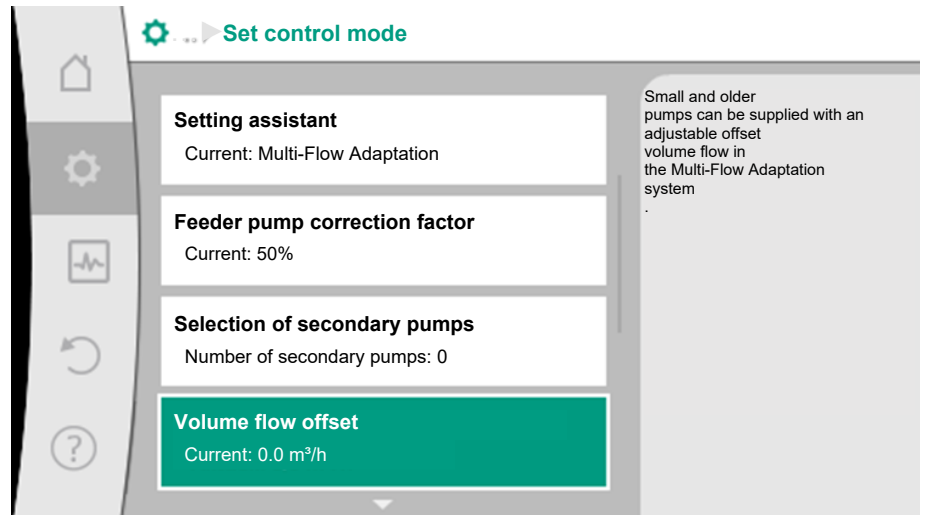

Fig. 38: Setting volume flow offset

#### 4.6 Configuration storage/data storage

The electronic module is equipped with a non-fading memory for saving the configuration. If the mains supply is interrupted for any length of time, all settings and data are retained. When power is restored, the pump continues to run with the default values that were present before the interruption.



#### NOTICE

The recorded operating data are stored in the data memory in a non-fading manner every 30 minutes. If the pump is switched off via the mains voltage before the 30 minutes have elapsed, the data recorded since the start of the most recent 30-minute time period are not stored. The data are then lost. It is therefore recommended to only switch off the pump via a digital input with EXT. OFF.

The Wilo-Stratos MAXO is able to record and save a range of timestamped data relating to its operating time:

- Delivery head
- Volume flow
- Speed
- Feed and return temperature
- Hall temperature (in case of hall temperature control)
- Heating and cooling quantity
- Electrical power consumption
- Voltage
- Operating hours
- History of fault and warning messages

The history data can be presented over a desired period, e.g. the last four weeks. Aspects such as the hydraulic behaviour of the hydraulic circuit being supplied or the current state of the pump can thus be analysed.

During a period without any mains voltage applied to the pump, the time stamp is set continuously with the help of a battery.

To view this data, the Wilo-Smart connect app must be connected to the pump via Bluetooth. The data can then be read from the pump and displayed in the app.

#### 4.7 Heating/cooling quantity measurement

The heating or cooling quantity is recorded by the pump's volume flow detection and checking the temperature in the feed and return.

A temperature sensor in the pump housing records either the feed or the return temperature, depending on its installation position.

A second temperature sensor must be connected to the pump using analogue inputs AI1 or AI2.



## NOTICE

The “-R7” version of the Stratos MAXO/-D has no internal temperature sensor. The “internal sensor” cannot therefore be selected as a sensor source in the feed or return. Only sensors connected to AI1 and AI2 can be selected.

The heating and cooling quantity is identified separately based on the application.



## NOTICE

The energy measurement for heating or cooling can be conducted without an additional energy meter. The measurement can be used for the internal distribution of heating and cooling costs or for system monitoring. As the heating and cooling quantity measurement is not calibrated, it cannot be used as the basis for billing.

### Activating heating/cooling quantity measurement

In the “Diagnostics and measured values” menu , select

1. “Heating/cooling quantity measurement”
2. Select “Heating/cooling quantity On/Off”.

Then configure the sensor source and sensor position in the “Sensor feed temperature” and “Sensor return temperature” menu items.

### Configuring the sensor source in the feed

In the “Diagnostics and measured values” menu , select

1. “Heating/cooling quantity measurement”
2. “Sensor feed temperature”
3. Select “Select sensor source”.

### Configuring the sensor source in the return

In the “Diagnostics and measured values” menu , select

1. “Heating/cooling quantity measurement”
2. “Sensor return temperature”
3. Select “Select sensor source”.

### Potential sensor source options:

- Internal sensor (\*)
- Analogue input (AI1)
- Analogue input (AI2)
- CIF module

### Configuring the sensor position in the feed

1. “Heating/cooling quantity measurement”
2. “Sensor feed temperature”
3. Select “Select sensor position”.

Select “Internal sensor”, (\*) “Feed” or “Return” as the sensor positions.

### Configuring the sensor position in the return

1. “Heating/cooling quantity measurement”
2. “Sensor return temperature”
3. Select “Select sensor position”.

Select “Internal sensor”, (\*) “Feed” or “Return” as the sensor positions.

### Potential sensor position options:

- Internal sensor (\*)

- Analogue input (AI1)
- Analogue input (AI2)
- BMS (Building management systems)
- Feed
- Return
- Primary circuit 1
- Primary circuit 2
- Secondary circuit 1
- Secondary circuit 2
- Accumulator
- Hall
- Circulation

(\* ) not selectable for the R7 variant



### NOTICE

When the heating or cooling quantity measurement is activated, this menu can be used to read the total overall heating or cooling quantity. The current heating and cooling capacity is displayed. If desired, the heating quantity can be re-set to 0 here.



### NOTICE

For constant recording of the heating/cooling quantity without interrupting data recording, the pump must only be switched on/off via a digital input with EXT. OFF. There is no data recording when the mains voltage is switched off.

## 4.8 Setback operation

For details on the “Night setback” additional control function, see the “Additional control functions” “Night setback [▶ 20]” section.

### Activating night setback

In the “Settings” menu , select

1. “Set control mode”
2. “Night setback”
3. “Switched on” in sequence.

## 4.9 Restore and reset

Saved settings can be retrieved via restore points in the “Restore and reset” menu, but the pump can also be reset to factory settings.

### 4.9.1 Restore points

When the pump has been completely configured, e.g. for commissioning, the configured settings can be saved. If there has been a change in the settings in the meantime, the saved settings can be retrieved via the restore points.

Up to three different pump settings can be saved as restore points. If required, these saved settings can be retrieved/restored via the “Restore settings” menu.



### NOTICE

The settings of both drives are saved in the twin-head pump.

### Save settings

In the  “Restore and reset” menu, select

1. “Restore points”
2. “Save settings” in sequence.



## NOTICE

The time saved is shown for each restore point in “Operating data and measurement area” (see “Home screen” illustration).

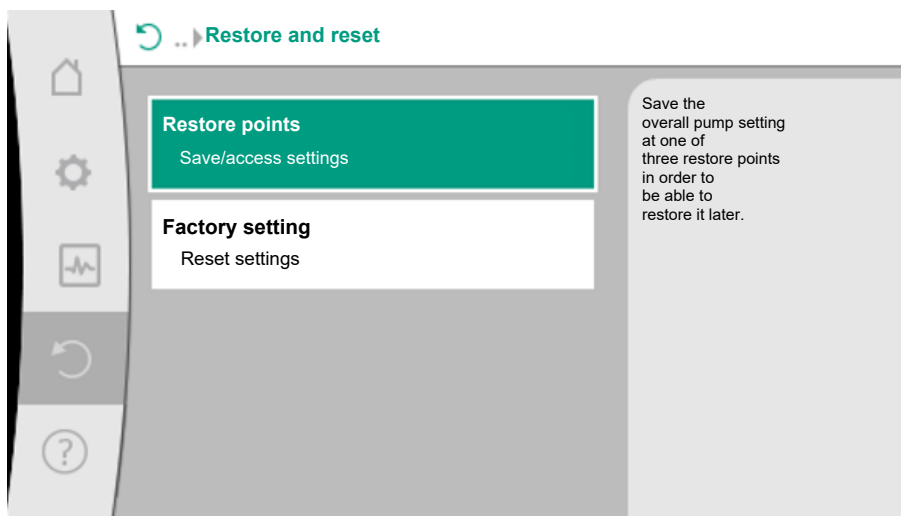

Fig. 39: Restore points

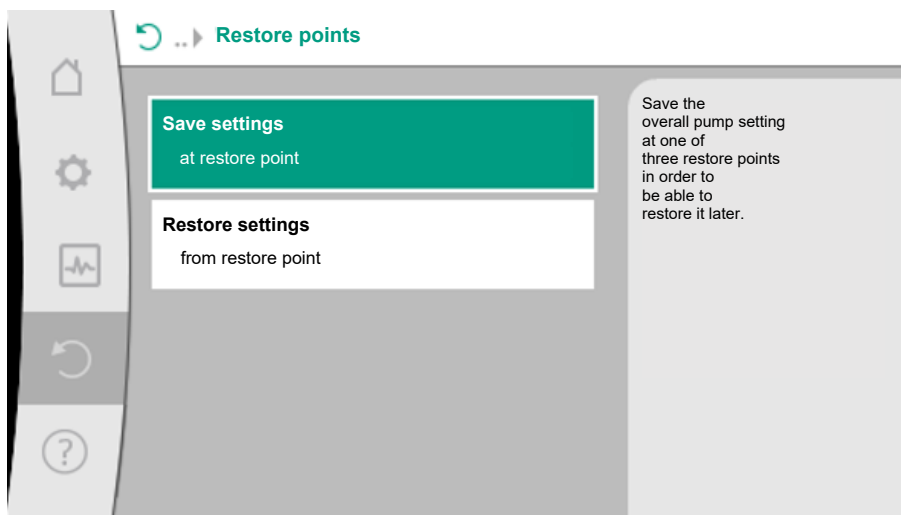



Fig. 40: Restore points – Save settings

### Restore settings

In the  “Restore and reset” menu, select

1. “Restore points”
2. “Restore settings” in sequence.



## NOTICE

The current settings are overwritten by the restored settings!



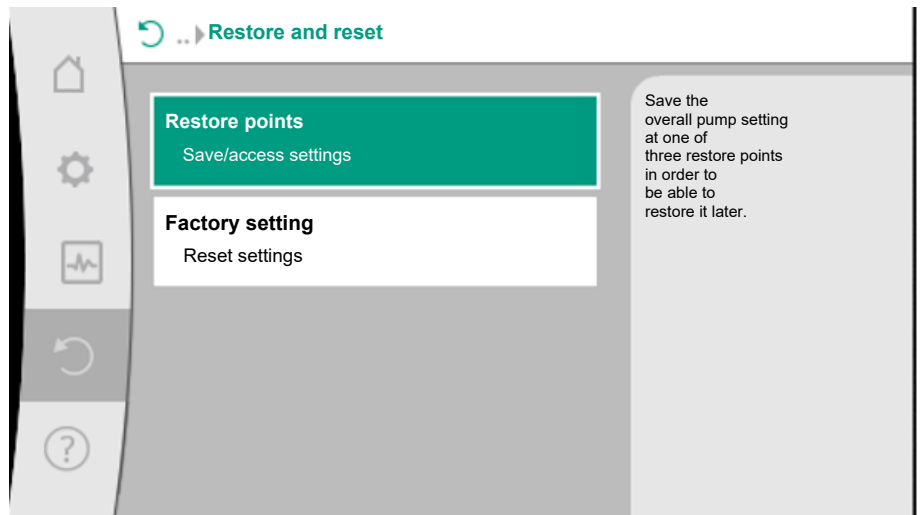

Fig. 41: Restore points

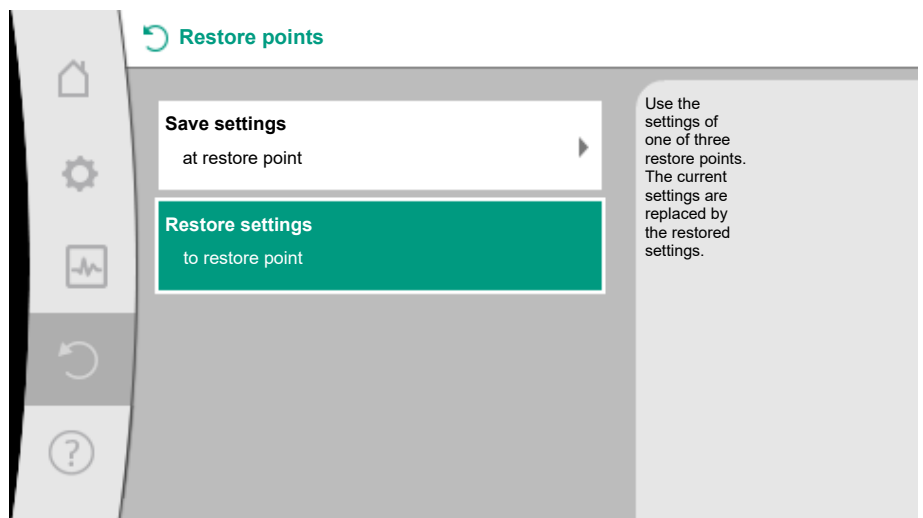



Fig. 42: Restore points – Restore settings

#### 4.9.2 Factory setting

The pump can be reset to factory settings.

In the  “Restore and reset” menu, select

1. “Factory setting”
2. “Restore factory setting”
3. “Factory settings (BMS remains)” or “Factory settings complete”
4. and “Confirm factory setting” in sequence.



#### NOTICE

Resetting pump settings to factory settings replaces the current pump settings!

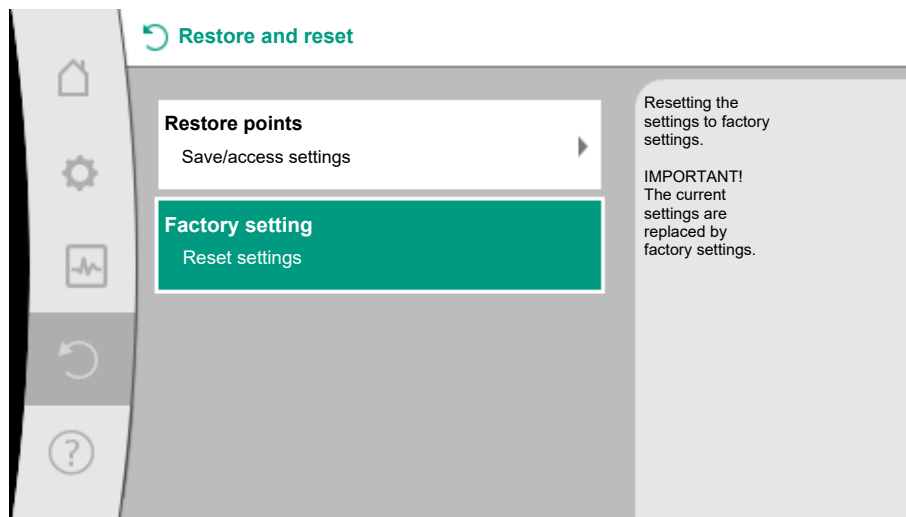

Fig. 43: Factory setting

#### 4.9.3 Factory settings – defaults and parameters

Settings	Stratos MAXO (-D)	Stratos MAXO-Z
<b>Set control mode</b>		
Setting assistant	Radiator – Dynamic Adapt plus	Circulation – T-const.
Pump On/Off	Motor on	Motor on
<b>Dual-pump operation</b>		
Connect twin-head pump	Single pump: not connected Twin-head pump/two-pump system: connected	- -
Twin-head pump alteration	24 h	-
<b>Additional functions</b>		
No-Flow Stop	not active	not active
$Q_{Limit}$	not active	not active
Night setback	not active	not active
Bluetooth	active	active
<b>External interfaces</b>		
<b>SSM relay</b>		
Function SSM relay	Fault(s) only	Fault(s) only
Trigger delay	5 s	5 s
Reset delay	5 s	5 s
<b>SBM relay</b>		
Function SBM relay	Motor in operation	Motor in operation
Trigger delay	5 s	5 s
Reset delay	5 s	5 s
<b>DI1</b>	not configured	not configured
<b>DI2</b>	not configured	not configured
<b>AI1</b>	not configured	not configured
<b>AI2</b>	not configured	not configured
<b>Wilco Net</b>		
Wilco Net termination	switched on (for twin-head pumps)	switched off
Wilco Net address	Twin-head pump Main pump: ID 1 Standby pump: ID 2 Single pump: ID 127	ID 127

Settings	Stratos MAXO (-D)	Stratos MAXO-Z
<b>Device settings</b>		
Language	English	English
Units	m, m <sup>3</sup> /h	m, m <sup>3</sup> /h
Pump kick	switched on	switched on
Pump kick time interval	24 h	24 h
<b>Diagnostics and measured values</b>		
<b>Diagnostics help</b>		
SSM forced control (normal, active, inactive)	inactive	inactive
SBM forced control (normal, active, inactive)	inactive	inactive
<b>Heating/cooling quantity measurement</b>		
Heat/cooling quantity On/Off	switched off	switched off
Sensor feed temperature	not configured	not configured
Return temperature sensor	not configured	not configured
<b>Maintenance</b>		
Pump kick	switched on	switched on
Pump kick time interval	24 h	24 h
Basic function mode	Control mode	Control mode
Ramp time	0 s	0 s

Table 17: Factory settings

#### 4.10 Operating data/statistics

In the “Diagnostics and measured values” menu , select

1. “Operating data, statistics”.

The following operating data, measurement data and statistical data are displayed:

- Hydraulic operating data
  - Actual delivery head
  - Actual volume flow
  - Actual fluid temperature (if a temperature sensor is connected and configured)
- Electrical operating data
  - Mains voltage
  - Power consumption
  - Total energy absorbed
  - Operating hours
- Measured heat quantity
  - Total heating quantity
  - Heat quantity since the last time the counter was re-set
  - Actual heat output
  - Actual feed temperature
  - Actual return temperature
  - Actual volume flow
- Measured cooling quantity
  - Total cooling quantity
  - Cooling quantity since the last time the counter was re-set
  - Actual cooling output
  - Actual feed temperature
  - Actual return temperature
  - Actual volume flow

##### 4.10.1 Accuracy of the displayed and recorded operating data

###### Volume flow

The accuracy of the volume flow specification with pure water is approx. +/- 5 % of the duty point.

If a water-glycol mixture is used, the accuracy decreases.

#### Temperature

A temperature sensor is installed in the pump housing for temperature detection (exception: R7 variant).

The accuracy of the temperature is  $\pm 0.5$  K in the temperature range of  $+40$  °C to  $+80$  °C. Outside these temperatures ( $-10$  °C to  $+40$  °C and  $+80$  °C to  $+110$  °C) the accuracy is  $\pm 2$  K.

#### Heating/cooling quantity measurement

The information on the heating and cooling quantity is derived from the recorded temperatures in the feed and return and from the volume flow. The accuracy of the heat quantity measurement is  $\pm 10$  %, that of the cooling quantity measurement  $\pm 25$  %.

## 4.11 Pump venting

Trapped air in the pump housing causes noise. Open the “Pump venting” function in the



“Diagnostics and measured values” menu to vent the pump hydraulics.

In the “Diagnostics and measured values” menu , select

1. “Maintenance”
2. “Pump venting” in sequence.

The “pump venting” procedure runs for 10 minutes, but it can be stopped at any time by pressing the Context button  “Cancel pump venting”.

#### **Pump venting for twin-head pumps**

With the Stratos MAXO-D, the pump venting function can be activated on both drives. The function can be activated as described above on the left drive side with the graphic display.

For the right drive side with the LED display, simply press the control knob.

The “pump venting” procedure runs for 10 minutes, but it can be stopped at any time on the pump drive with graphic display by pressing the Context button  “Cancel pump venting”.

For the pump drive with the LED display, press the control knob again.

#### **Pump venting indicator on the 7-segment display**

In the sequence of the pump venting function, the lower, centre and then the upper 4 LED bars are shown on the display one after the other.



Fig. 44: Pump venting on the 7-segment display

## 4.12 Pump kick

In order to avoid impeller/rotor blockages when the pump is at standstill for longer periods (e.g. an inactive heating system during summer), the pump regularly performs pump kicks by briefly starting it. In this process, it starts briefly.

If the pump does not start operating within an interval of 24 hours (factory setting), the system completes a pump kick. In this process, the pump must always be supplied with power. You can change the pump kick interval at the pump.

In the “Diagnostics and measured values” menu , select

1. “Maintenance”
2. “Pump kick” in sequence.

The pump kick can be switched on and off.

- **Pumps with SW version (SW  $\leq$  01.04.):**
  - Time interval between 1 hour and 24 hours, factory setting: 24 h
- **Pumps with SW version (SW  $\geq$  01.05.):**
  - Time interval between 2 hour and 72 hours, factory setting: 24 h

### 4.13 Ramp times

The ramp times define the maximum speed at which the pump may start up and shut down when the setpoint changes. During start-up, the time refers to the jump from minimum to maximum speed. During shutdown, it refers to the jump from maximum to minimum speed. The ramp times can be set on the pump.

In the “Diagnostics and measured values” menu , select

1. “Maintenance”
2. “Ramp times” in sequence.

## 5 Double pump operation

### 5.1 Function

All Stratos MAXO pumps are fitted with integrated dual-pump management. The Stratos MAXO-D is delivered from the factory ready assembled as a twin-head pump with the dual-pump management main/standby operation.

#### 5.1.1 Main/standby operation

Each of the two pumps provides the configured flow rate. The other pump is available in case of malfunction or runs after pump cycling.

Only one pump runs at a time (factory setting).

The main/standby operation is also completely active even for two similar single pumps in a two-pump installation in the Y-piece.

#### 5.1.2 Efficiency-optimised peak-load operation (parallel operation)

In peak-load operation (parallel operation), the hydraulic output is provided jointly by both pumps.

In the partial load range, the hydraulic output is initially provided by just one of the two pumps.

If the sum of the electrical power consumption P1 of both pumps in the partial load range is less than the power consumption P1 of one pump, then the second pump is switched on with optimised efficiency.

This operating mode optimises operational efficiency compared to conventional peak-load operation (exclusively load-sensitive switching on and off).

If only one pump is available, the remaining pump takes over the supply. The possible peak load is limited due to the power of the single pump. Parallel operation is also possible with two single pumps of the same type in dual-pump operation in the Y-piece.

### 5.2 Dual-pump operation settings

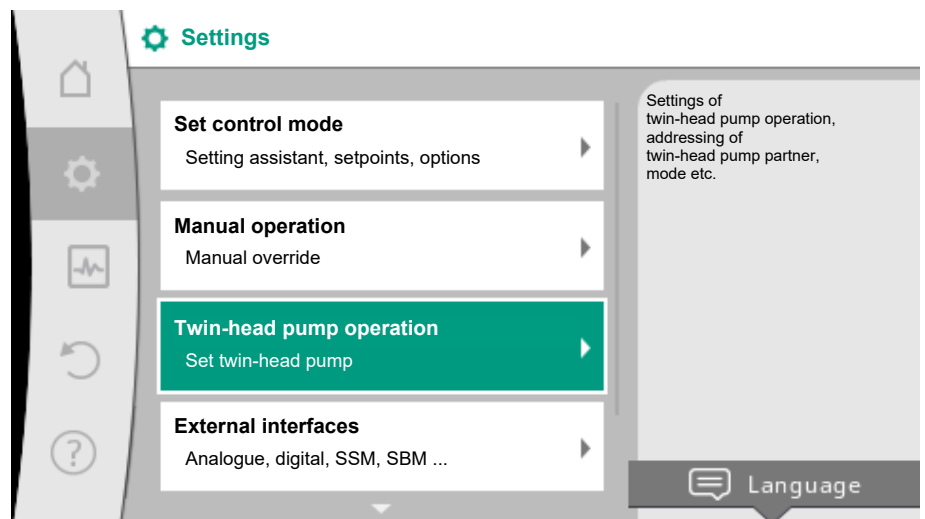

Fig. 45: Menu Dual-pump operation

In the “Dual-pump operation” menu, a twin-head pump connection can be established or disconnected and the dual-pump function can also be adjusted.

In the  Settings menu, select

1. “Dual-pump operation”.

#### 5.2.1 Menu “Dual-pump function”

When a twin-head pump connection is established, the “Double pump function” menu can be used to switch between the following functions:

- **Main/standby operation** and
- **Efficiency-optimised peak-load operation (parallel operation)**

**NOTICE**

When switching the dual-pump function, different parameters of the pump are fundamentally changed. The pump is then started automatically.

**5.2.2 Menu “Connecting twin-head pump”**

If twin-head pump connection is not yet established, in the “Settings” menu , select

1. “Dual-pump operation”
2. “Connecting twin-head pump”.

When the Wilo Net connection is established (see “Application and function of the Wilo Net interface [▶ 76]” section), a list of available and appropriate dual-pump partners will appear under “Connecting twin-head pump”.

Appropriate dual-pump partners are pumps of the same type.

When the dual-pump partner is selected, the display of this dual-pump partner is switched on (Focus mode). In addition, the blue LED will flash to identify the pump.

**NOTICE**

Activating the twin-head pump connection fundamentally changes various parameters of the pump. The pump is then started automatically.

**NOTICE**

If there is an error in the twin-head pump connection, reconfigure the partner address! Always check the partner addresses beforehand!

**5.2.3 Menu “Disconnect twin-head pump”**

When a dual-pump function is established, it can also be separated. Select “Disconnect twin-head pump” in the menu.

**NOTICE**

Disconnecting the dual-pump function fundamentally changes various parameters of the pump. The pump is then started automatically.

**5.2.4 Menu “Type of twin-head pump housing”**

The selection at which hydraulic position a motor head is mounted is made independently of a twin-head pump connection.

The following selection is available in the “Type of twin-head pump housing” menu:

- Single pump hydraulic
- Twin-head pump hydraulic I (left, with upward flow direction)
- Twin-head pump hydraulic II (right, with upward flow direction)

With an existing twin-head pump connection, the second motor head automatically accepts the complementary setting.

- When the variant “Twin-head pump hydraulic I” is selected, the other motor head automatically adjusts to “Twin-head pump hydraulic II”.
- When the variant “Single pump hydraulic” is selected, the other motor head automatically adjusts to “Single pump hydraulic”.

**NOTICE**

The configuration of the hydraulics must be carried out before establishing the twin-head pump connection. With twin-head pumps delivered from the factory, the hydraulic position is pre-configured.

**5.2.5 Menu “Pump cycling interval”**

The actively operated pump is regularly changed automatically to guarantee even usage of both pumps in the event of single pump operation.

If only one pump (main/standby, peak load or night setback) is running, the pump being operated is changed after a running time of 24 h at the latest (factory setting). Both pumps run at the time of pump changeover so that operation is not interrupted.



**NOTICE**

The remaining time until the next pump cycling is recorded via a timer. The timer stops if there is a mains interruption. After switching the mains voltage on again, the remaining time until the next pump cycling continues to run.

The count does not start again from scratch!

If a twin-head pump connection is established, the time interval can be set in the “Pump cycling interval” menu.

- **Pumps with SW version (SW ≤ 01.04.):**
  - Time interval between 6 mins. and 24 h, factory setting: 24 h
- **Pumps with SW version (SW ≥ 01.05.):**
  - Time interval between 1 h and 36 h, factory setting: 24 h

**5.3 Display for twin-head pump operation**

Two pump symbols are displayed in dual-pump operation in the “Active influences” area. This is what they mean:

- The left symbol represents the pump being viewed.
- The right-hand symbol represents the partner pump.

The symbols on the display differ for a generic twin-head pump and a two-pump system installed with two single pumps in the Y-piece.

**5.3.1 Generic twin-head pump**

On the twin-head pump, the left drive is equipped with a graphic display and the right drive with an LED display.

The graphic display of the main pump shows the values and settings.

On the graphic display, the home screen is visible as with a single pump.

Nothing is shown on the LED display of the partner pump.

Illustration of the pump symbols and meaning:

	Display of main pump	Display of partner pump	Description
Case 1			Main/standby operation: Only the main pump is running.
Case 2			Main/standby operation: Only the partner pump is running.
Case 3			Parallel operation: Only the main pump is running.
Case 4			Parallel operation: Only the partner pump is running.
Case 5			Parallel operation: The main pump and partner pump are running.
Case 6			Main/standby operation or parallel operation: No pump running.

**5.3.2 Two single pumps as a two-pump system in Y-piece joint**

If two single pumps are operated as a two-pump system in a Y-piece installation, each pump has a graphic display showing values and settings.



**NOTICE**

























The actual values shown on the display of the pump drive that is not in operation correspond 1:1 to the values of the active drive.



**NOTICE**

If a twin-head pump connection is established, entries on the graphic display of the pump partner are not possible. This can be identified by a lock symbol on the “Main menu symbol”.

















Illustration of the pump symbols and meaning:

	Display of main pump	Display of partner pump	Description
Case 1	   	   	Main/standby operation: Only the main pump is running.
Case 2	   	   	Main/standby operation: Only the partner pump is running.
Case 3	 + 	 + 	Parallel operation: Only the main pump is running.
Case 4	 + 	 + 	Parallel operation: Only the partner pump is running.
Case 5	 + 	 + 	Parallel operation: The main pump and partner pump are running.
Case 6	 + 	 + 	Main/standby operation or parallel operation: No pump running.

### 5.3.3 Active influences of the pump status on the display in the home screen for twin-head pumps

The active influences are listed from highest to lowest priority.

- The left symbol represents the pump being viewed.
- The right-hand symbol represents the partner pump.

Name	Displayed symbols	Description
Main/standby operation: Error on partner pump OFF	   	Twin-head pump is set in main/standby operation. This pump head is <b>inactive</b> due to: <ul style="list-style-type: none"> <li>• Control mode</li> <li>• Error at the pump partner.</li> </ul>
Main/standby operation: Error at the partner pump	   	Twin-head pump is set in main/standby operation. This pump head is <b>active</b> due to a fault at the pump partner.
Main/standby operation: OFF	   	Twin-head pump is set in main/standby operation. Both pumps are <b>inactive</b> in control mode.
Main/standby operation: This pump head is active	   	Twin-head pump is set in main/standby operation. This pump head is <b>active</b> in control mode.
Main/standby operation: Partner pump active	   	Twin-head pump is set in main/standby operation. The pump partner is <b>active</b> in control mode.
Parallel operation: OFF	 + 	Twin-head pump is set in parallel operation. Both pumps are <b>inactive</b> in control mode.
Parallel operation: Parallel operation	 + 	Twin-head pump is set in parallel operation. Both pumps are <b>active</b> in parallel in control mode.
Parallel operation: This pump head active	 + 	Twin-head pump is set in parallel operation. This pump head is <b>active</b> in control mode. The pump partner is <b>inactive</b> .



Name	Displayed symbols	Description
Parallel operation: Pump partner active		Twin-head pump is set in parallel operation. The pump partner is <b>active</b> in control mode. This pump head is <b>inactive</b> . In the event of an error at the pump partner, this pump head will run.

Table 18: Active influences

#### 5.4 Behaviour EXT. OFF for twin-head pumps

The function EXT. OFF always behaves as follows:

- EXT. OFF active: contact is open, pump is stopped (OFF).
- EXT. OFF inactive: contact is closed, pump runs in normal operation (ON).

**Pumps from SW ≥ 01.05.10.00:** The configuration of the control inputs has three possible modes for EXT. OFF which can influence the behaviour of the two dual-pump partners.

##### 5.4.1 System mode

The control input of the main pump is occupied with a control cable and configured to EXT. OFF.

The control input on the **main pump switches both dual-pump partners**.

The **control input of the partner pump** is ignored and **has no significance** regardless of its configuration. If the main pump malfunctions or if the twin-head pump connection is disconnected, the partner pump is also stopped.

States	Main pump			Partner pump		
	EXT. OFF	Behaviour of the pump motor	Display text for active influences	EXT. OFF	Behaviour of the pump motor	Display text for active influences
1	Active	Off	OFF Override OFF (D11/2)	Active	Off	OFF Override OFF (D11/2)
2	Not active	On	OK; normal operation	Active	On	OK; normal operation
3	Active	Off	OFF Override OFF (D11/2)	Not active	Off	OFF Override OFF (D11/2)
4	Not active	On	OK; normal operation	Not active	On	OK; normal operation

Table 19: System mode

##### 5.4.2 Single pump mode

###### Single pump mode

The control input of the main pump and the control input of the partner pump are respectively occupied with a control cable and configured to EXT. OFF. **Each of the two pumps is individually switched by its own control input.** If the main pump malfunctions or if the twin-head pump connection is disconnected, the control input of the partner pump is assessed.

Alternatively, a cable jumper can also be put on the partner pump instead of a separate control cable.

States	Main pump			Partner pump		
	EXT. OFF	Behaviour of the pump motor	Display text for active influences	EXT. OFF	Behaviour of the pump motor	Display text for active influences
1	Active	Off	OFF Override OFF (D11/2)	Active	Off	OFF Override OFF (D11/2)
2	Not active	On	OK; normal operation	Active	Off	OFF Override OFF (D11/2)

States	Main pump			Partner pump		
	EXT. OFF	Behaviour of the pump motor	Display text for active influences	EXT. OFF	Behaviour of the pump motor	Display text for active influences
3	Active	Off	OFF Override OFF (DI1/2)	Not active	On	OK; normal operation
4	Not active	On	OK; normal operation	Not active	On	OK; normal operation

Table 20: Single pump mode

### 5.4.3 Combined mode

#### Combined mode

The control input of the main pump and the control input of the partner pump are respectively occupied with a control cable and configured to EXT. OFF. **The control input of the main pump switches both dual-pump partners off. The control input of the partner pump only switches the partner pump off.** If the main pump malfunctions or if the twin-head pump connection is disconnected, the control input of the partner pump is assessed.

States	Main pump			Partner pump		
	EXT. OFF	Behaviour of the pump motor	Display text for active influences	EXT. OFF	Behaviour of the pump motor	Display text for active influences
1	Active	Off	OFF Override OFF (DI1/2)	Active	Off	OFF Override OFF (DI1/2)
2	Not active	On	OK; normal operation	Active	Off	OFF Override OFF (DI1/2)
3	Active	Off	OFF Override OFF (DI1/2)	Not active	Off	OFF Override OFF (DI1/2)
4	Not active	On	OK; normal operation	Not active	On	OK; normal operation

Table 21: Combined mode

## 6 Communication interfaces: Setting and function

In the “Settings” menu , select

1. “External interfaces”.

Possible selection:

External interface
▸ Function SSM relay
▸ Function SBM relay
▸ Function control input (DI1)
▸ Function control input (DI2)
▸ Function analogue input (AI1)
▸ Function analogue input (AI2)
▸ Setting Wilo Net

Table 22: Selection “External interfaces”

### 6.1 Application and function of SSM relay

The contact of the collective fault signal (SSM, potential-free changeover contact) can be connected to a building automation system. The SSM relay can either switch on only in case of fault or for faults and warnings.

- When the pump does not have electricity or if there is no fault, the contact between the terminals COM (75) and OK (76) is closed. The contact is open in all other cases.

- If there is a fault, the contact between the terminals COM (75) and Fault (78) is closed. It is open in all other cases.

In the “Settings” menu , select

1. “External interfaces”
2. “SSM relay function”.

Possible settings:

Selection option	Function SSM relay
Only fault (factory setting)	SSM relay connects only in case of fault. Fault means: The pump is not running.
Faults and warnings	SSM relay connects only in case of fault or a warning.

Table 23: Function SSM relay

After confirming one of the selection options, the SSM trigger delay and SSM reset delay are entered.

Setting	Range in seconds
SSM trigger delay	0 s ... 60 s
SSM reset delay	0 s ... 60 s

Table 24: Trigger and reset delay

- Triggering of the SSM signal after occurrence of a fault or a warning is delayed.
- Resetting of the SSM signal after occurrence of a fault or a warning is delayed.

Trigger delays are used so that processes are not influenced by very short fault or warning messages.

If a fault or a warning is fixed before the end of the set time, there will be no message to SSM.

A set SSM trigger delay of 0 seconds immediately reports faults or warnings.

If an error message or warning message occurs only for a brief duration (e.g. in case of a loose contact), the reset delay prevents the SSM signal from fluttering.



#### NOTICE

SSM trigger and SSM reset delay is set to 5 seconds as a factory setting.

- **SSM/ESM (collective fault signal/individual fault signal) in twin-head pump operation:**
  - The **SSM function** must preferably be connected to the main pump. The SSM contact can be configured as follows:
    - the contact reacts either only in the event of a fault or in the event of a fault and a warning.
    - Factory setting** SSM only reacts in the event of a fault.
    - Alternatively or additionally, the SSM function can also be activated on the standby pump. Both contacts work in parallel.
  - **ESM:** The ESM function of the twin-head pump can be configured on each head of the twin-head pump head as follows: The ESM function on the SSM contact only signals faults of the respective pump (individual fault signal). In order to record all faults of the two pumps, both contacts must be assigned.

## 6.2 Application and function of SBM relay

The contact of the collective run signal (SBM, potential-free normally open contact) can be connected to a building automation system. The SBM contact signals the operating status of the pump. The SBM relay can either switch on for “Motor in operation”, “Ready for operation” or for “Power supply ready”.

- When the pump is running in the set operating mode and based on the next settings, the contact between the terminals COM (85) and RUN (88) are closed.

In the “Settings” menu , select

1. “External interfaces”
2. “SBM relay function”.

Possible settings:

Selection option	Function SSM relay
Motor in operation (factory setting)	SBM relay connects only when motor is running. Closed relay: The pump is supplying.
Power supply ready	SBM relay connects for power supply. Closed relay: Voltage available.
Ready for operation	SBM relay connects when there is no fault. Closed relay: Pump can supply.

Table 25: Function SBM relay



### NOTICE

From **SW ≥ 01.05.10.00**, the following behaviour applies:  
 if SBM is set to “Motor in operation”, the SBM relay switches when No-Flow Stop is active.  
 If SBM is set to “Ready for operation”, the SBM relay does not switch when No-Flow Stop is active.

After confirming one of the selection options, the SBM trigger delay and SBM reset delay are entered.

Setting	Range in seconds
SBM trigger delay	0 s to 60 s
SBM reset delay	0 s to 60 s

Table 26: Trigger and reset delay

- Triggering of the SBM signal after changing an operating status is delayed.
- Resetting of the SBM signal after changing the operating status is delayed.

Trigger delays are used so that processes are not influenced by very brief changes in the operating state.

If an operating state change can be reversed before the end of the set time, the change is not reported to the SBM.

A set SBM trigger delay of 0 seconds reports an operating state change immediately.

When an operating status change occurs only for a short duration, the reset delay prevents a flutter of the SBM signal.



### NOTICE

SBM trigger and SBM reset delay is set to 5 seconds as a factory setting.

#### SBM/EBM (collective run signal/individual run signal) in dual-pump operation

- **SBM:** The SBM contact can be assigned to any of the two pumps. Both contacts signal the operating status of the twin-head pump in parallel (collective run signal).
- **EBM:** The SBM function of the twin-head pump/two-pump system can be configured so that the SBM contacts signal only operational messages of the respective pump (individual run signal). In order to record run signals of both the pumps, both contacts must be assigned.

### 6.3 Setting individual fault signal (ESM) for twin-head pumps

In the  “Settings” menu, select the following in sequence:

1. “External interfaces”
2. “SSM relay function”
3. “Only errors” or “Faults and warnings”
4. “SSM trigger delay”
5. “SSM reset delay”
6. “SSM/ESM twin-head pump”, SSM or ESM

Confirm selection by pressing the control knob.

#### 6.4 Setting individual run signal (EBM) for twin-head pumps

In the  “Settings” menu, select the following in sequence:

1. “External interfaces”
2. “SBM relay function”
3. “Motor in operation”, “Power supply ready” or “Ready for operation”
4. “SBM trigger delay”
5. “SBM reset delay”
6. “SBM/EBM twin head pump”, SBM or EBM

Confirm selection by pressing the control knob.

#### 6.5 SSM/SBM relay forced control

An SSM/SBM relay forced control is used as function test of the SSM/SBM relay and electrical connections.

In the “Diagnostics and measured values” menu , select

1. “Diagnostics help”
2. “SSM relay forced control” or “SBM relay forced control” in sequence.

Selection options:

SSM/SBM relay Forced control	Help text
Normal	<p><b>SSM:</b> Depending on the SSM configuration, fault and warnings influence the SSM relay switching status.</p> <p><b>SBM:</b> Depending on the SBM configuration, the pump status influences the SBM relay switching status.</p>
Forced active	<p>SSM/SBM relay switching status is forced ACTIVE.</p> <p><b>CAUTION:</b> <b>SSM/SBM does not display the pump status!</b></p>
Forced inactive	<p>SSM/SBM relay switching status is forced INACTIVE.</p> <p><b>CAUTION:</b> <b>SSM/SBM does not display the pump status!</b></p>

Table 27: Selection option SSM/SBM relay forced control

The “Forced active” setting permanently activates the relay. A warning/operating note (light) is permanently displayed/indicated.

The “Forced inactive” setting leaves the relay permanently without a signal. No warning/operating note can be confirmed.

#### 6.6 Application and function of the digital control inputs DI1 and DI2

The pump can be controlled through external potential-free contacts at the digital inputs DI1 and DI2. The pump can be

- switched on or switched off,
- controlled to maximum or minimum speed,
- set manually into an operating mode,
- protected against changes of settings through control or remote control or
- switched between heating and cooling.

See section “Adjustment – Manual operation [▶ 38]” for a detailed description of the OFF, MAX, MIN and MANUAL functions

In the “Settings” menu , select

1. “External interfaces”
2. “Function control input DI1” or “Function control input DI2”.

Possible settings:

Selection option	Function control input DI1 or DI2
Not used	The control input does not have a function.
External OFF	<p><b>Contact open:</b> Pump is switched off.</p> <p><b>Contact closed:</b> Pump is switched on.</p>



Selection option	Function control input DI1 or DI2
External MAX	<b>Contact open:</b> Pump is running in the mode set on the pump. <b>Contact closed:</b> Pump is running with maximum speed.
External MIN	<b>Contact open:</b> Pump is running in the mode set on the pump. <b>Contact closed:</b> Pump is running with minimum speed.
External MANUAL <sup>1)</sup>	<b>Contact open:</b> Pump is running in the mode set on the pump or in mode requested via bus communication. <b>Contact closed:</b> Pump is set to MANUAL.
External key lock <sup>2)</sup>	<b>Contact open:</b> Key lock is deactivated. <b>Contact closed:</b> Key lock is activated.
Heating/cooling switchover <sup>3)</sup>	<b>Contact open:</b> "Heating" active. <b>Contact closed:</b> "Cooling" active.

Table 28: Function control input DI1 or DI2

<sup>1)</sup> Function: see section "Adjustment – Manual operation [► 38]".

<sup>2)</sup> Function: see "Key lock On [► 79]" section.

<sup>3)</sup> To guarantee the heating/cooling switchover function operates correctly at the digital input:

1. go to  "Settings" menu, "Set control mode", "Setting assistant" and select the "Heating & cooling" application **and**
2. go to  "Settings" menu, "Set control mode", "Heating/cooling switchover" and select the "Binary input" option as switchover criterion.



#### NOTICE

During regular operation, it is preferable to switch the pump on or off via the DI1 or DI2 digital input with EXT. OFF rather than via the mains voltage!



#### NOTICE

The 24 V DC power supply is only available when the analogue input AI1 or AI2 has been configured to a type of use and a signal type or when the digital input DI1 has been configured.

### 6.6.1 Control input DI1 and DI2 priorities

#### Override function priorities

Priority*	Function
1	OFF, External OFF (binary input), External OFF (bus system)
2	MAX, External MAX (binary input), External MAX (bus system)
3	MIN, External MIN (binary input), External MIN (bus system)
4	MANUAL, External MANUAL (binary input)

Table 29: Override function priorities

\* Priority 1 = highest priority

#### Key lock priorities

Priority*	Function
1	Key lock: digital input active

Priority*	Function
2	Key lock active via menu and buttons
3	Key lock: not active

Table 30: Key lock priorities

\* Priority 1 = highest priority

#### Priorities for heating/cooling switchover using binary input

Priority*	Function
1	Cooling
2	Heating

Table 31: Priorities for heating/cooling switchover using binary input

\* Priority 1 = highest priority

## 6.7 Application and function of the analogue inputs AI1 and AI2

Analogue inputs can be used for setpoint input or actual value input. The allocation of setpoint and actual value specifications is freely configurable.

The type of use (setpoint sensor, differential pressure sensor, external sensor, etc.), the signal type (0 to 10 V, 0 to 20 mA, etc.) and the corresponding signal/value assignments are set via the menus "Function of analogue input AI1" and "Function analogue input AI2". In addition, information about the current settings can be queried.

The analogue input is pre-defined for the required signal depending on the selected control mode of the pump.

In the "Settings" menu , select

1. "External interfaces"

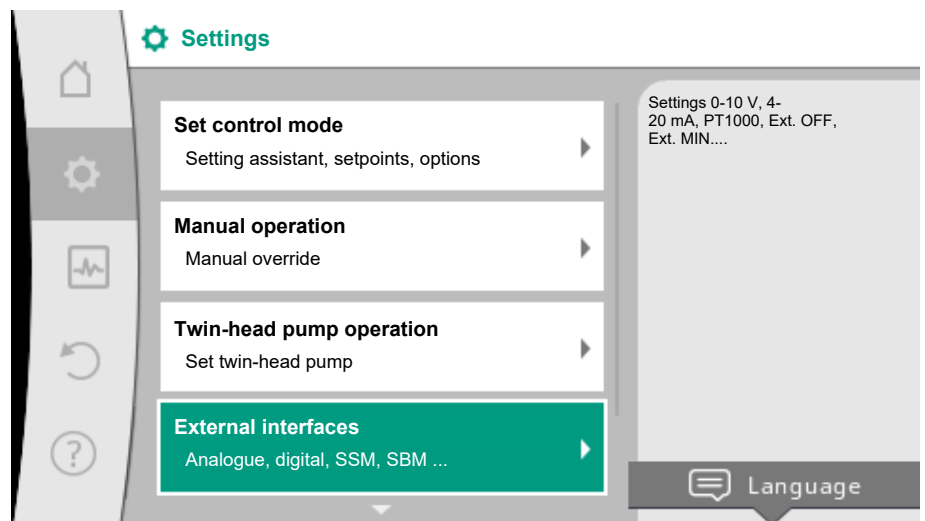

Fig. 46: External interfaces

2. "Function analogue input AI1" or "Function analogue input AI2" in sequence.

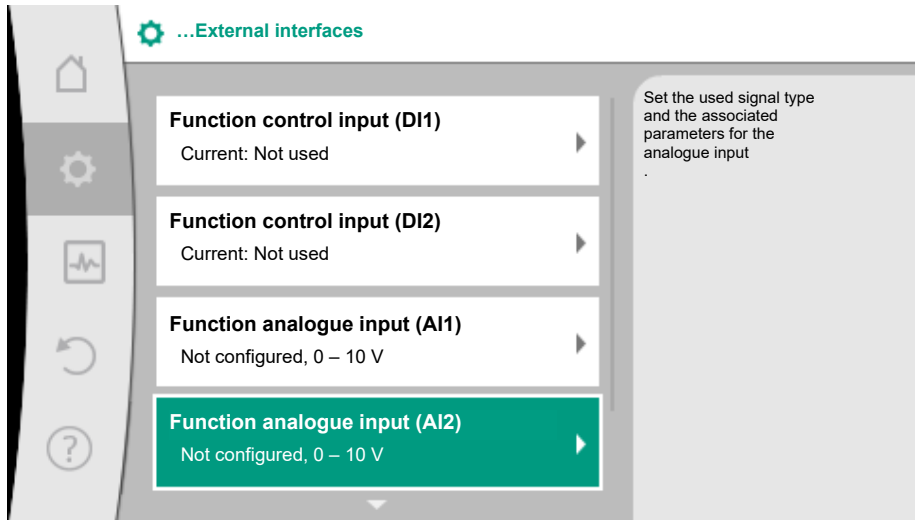

Fig. 47: Function analogue input

After selecting one of the options “Analogue input (AI1) function” or “Analogue input (AI2) function”, select the following query or setting:

Setting	Function control input AI1 or AI2
Overview of the analogue input	Overview of settings of this analogue input, for example: <ul style="list-style-type: none"> <li>• Type of use: Temperature sensor</li> <li>• Signal type: PT1000</li> </ul>
Set analogue input	Adjustment of type of use, signal type and corresponding signal/value assignment

Table 32: Setting analogue input AI1 or AI2

Information about the current settings can be retrieved in “Overview of the analogue input”.

The type of use, signal type and signal/values assignment are defined in “Set analogue input”.

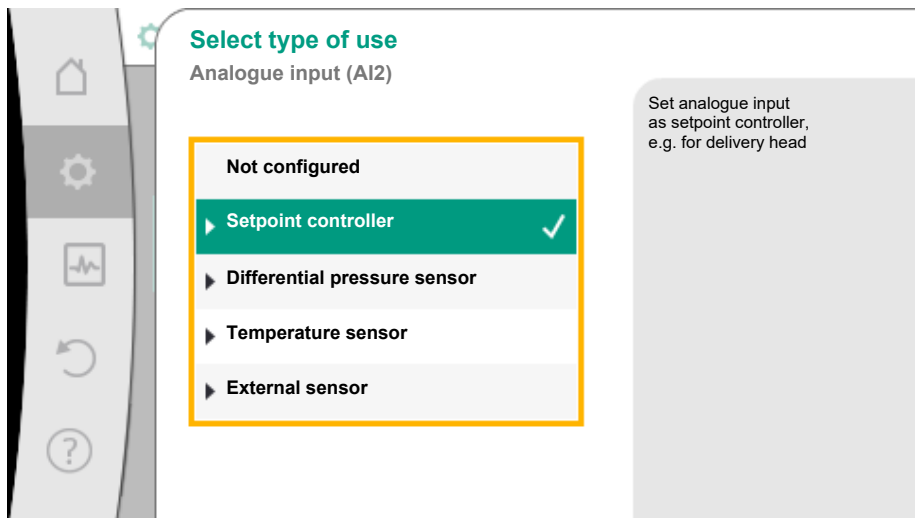

Fig. 48: Settings dialogue setpoint sensor

Type of use	Function
Not configured	This analogue input is not used. No settings required
Setpoint sensor	Use analogue input as setpoint sensor. For example, delivery head.
Differential pressure sensor	Use analogue input as actual value input for differential pressure sensor. For example, index circuit evaluator.



Type of use	Function
Temperature sensor	Use analogue input as actual value input for temperature sensor. For example for control mode T-const
External sensor	Use analogue input as actual value input for PID control.

Table 33: Types of use

The following signal types are available depending on the type of use:

Type of use	Signal type
Setpoint sensor	<ul style="list-style-type: none"> <li>• 0 – 10 V, 2 – 10 V</li> <li>• 0 to 20 mA, 4 to 20 mA</li> </ul>
Differential pressure sensor	<ul style="list-style-type: none"> <li>• 0 – 10 V, 2 – 10 V</li> <li>• 0 to 20 mA, 4 to 20 mA</li> </ul>
Temperature sensor	<ul style="list-style-type: none"> <li>• PT1000</li> <li>• 0 – 10 V, 2 – 10 V</li> <li>• 0 to 20 mA, 4 to 20 mA</li> </ul>
External sensor	<ul style="list-style-type: none"> <li>• 0 – 10 V, 2 – 10 V</li> <li>• 0 to 20 mA, 4 to 20 mA</li> </ul>

Table 34: Signal types

#### Example setpoint sensor

The following signal types are available for the type of use “Setpoint sensor”:

##### Setpoint sensor signal types:

**0 ... 10 V:** voltage range of 0 ... 10 V for transfer of setpoints.

**2 ... 10 V:** voltage range of 2 ... 10 V for transfer of setpoints. Cable break is detected for a voltage below 2 V.

**0 ... 20 mA:** electric current range of 0 ... 20 mA for transfer of setpoints.

**4 ... 20 mA:** electric current range of 4 ... 20 mA for transfer of setpoints. Cable break is detected for a electric current below 4 mA.



#### NOTICE

The substitute setpoint is adjusted in the event of cable break detection. For the signal types “0 ... 10 V” and “0 ... 20 mA”, a cable break detection with a parameterisable threshold can be optionally activated (see setpoint sensor configuration).

### 6.7.1 Setpoint sensor configuration



#### NOTICE

When an external signal is used at the analogue input as setpoint source, the setpoint value must be coupled to the analogue signal. Open the editor’s context menu for the affected setpoint for coupling.



#### NOTICE

The 24 V DC power supply is only available once the analogue input AI1 or AI2 has been configured for a type of use and a signal type.

The use of an external signal at the analogue input as setpoint source requires coupling of the setpoint value to the analogue signal:

In the “Settings” menu , select

1. “Set control mode”.

Depending on the selected control mode, the setpoint editor displays the adjusted setpoint (setpoint delivery head  $\Delta p-v$ , setpoint temperature  $T-c$ ,...).

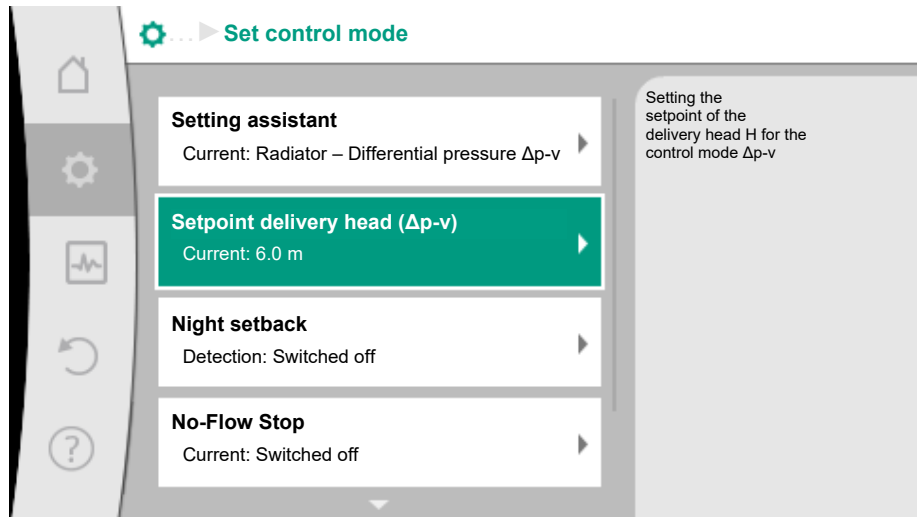



Fig. 49: Setpoint editor

2. Select setpoint and confirm by pressing the control knob.
3. Press Context button  and select "Setpoint of external source".

Selection of possible setpoint sources:

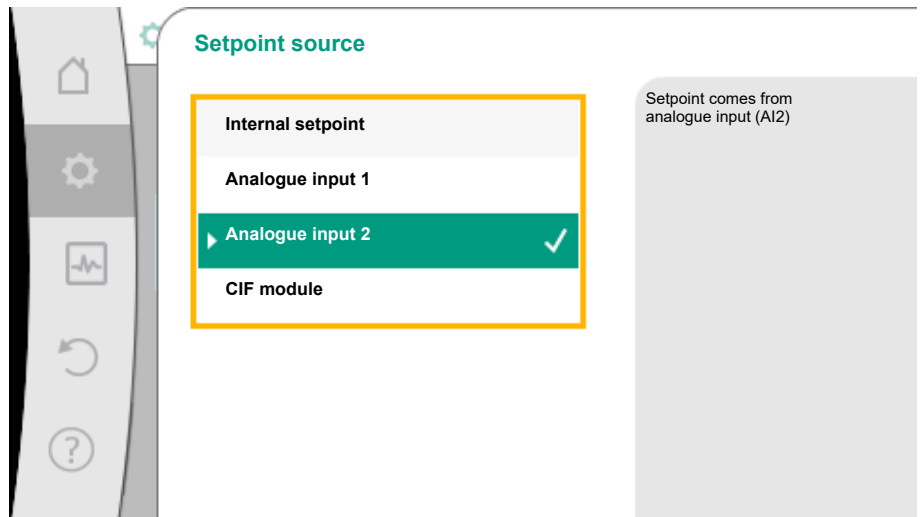

Fig. 50: Setpoint source



## NOTICE

When an analogue input is selected as setpoint source, but the type of use for example has been selected as "Not configured" or as actual value input, the pump displays a configuration warning. The fallback value is assumed to be the setpoint value. Either another source must be selected or the source must be configured as setpoint source.



### NOTICE

After selecting one of the external sources, the setpoint is coupled to this external source and can no longer be adjusted in the setpoint editor or on the home screen.

This coupling can only be cancelled in the context menu of the setpoint editor (as described above) or in the “External setpoint sensor” menu. The setpoint source must be adjusted again to “Internal setpoint”.

The coupling between external source and setpoint is marked both in the  home screen, and in the setpoint editor in **blue**. The status LED also becomes blue.

After selecting one of the external sources, the “External setpoint source” menu is available to configure the parameters of the external source.

For this purpose, go to the  “Settings” menu

1. “Set control mode”
2. “External setpoint source”.

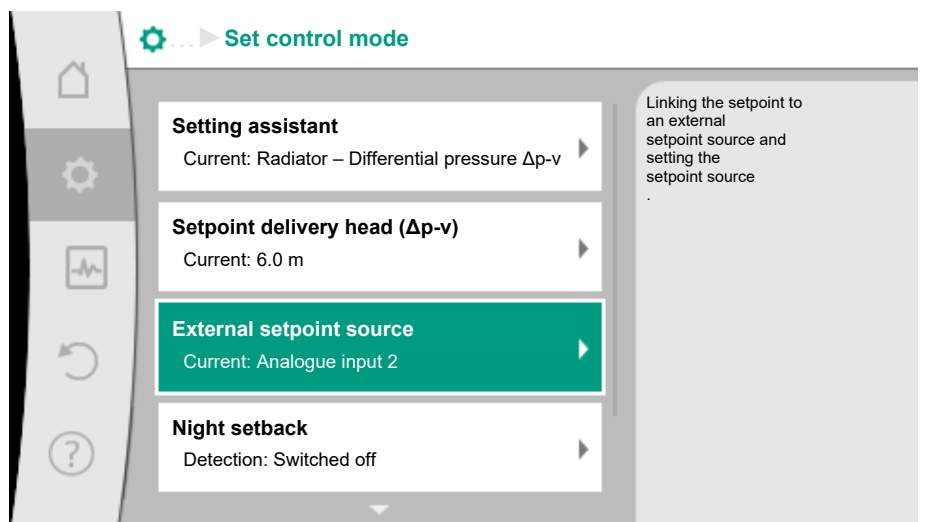

Fig. 51: External setpoint source

Possible selection:

Set input for external setpoint
<b>Select setpoint source</b>
Set setpoint source
Substitute setpoint in the event of a cable break

Table 35: Set input for external setpoint

The setpoint source can be changed in select “Setpoint source”.

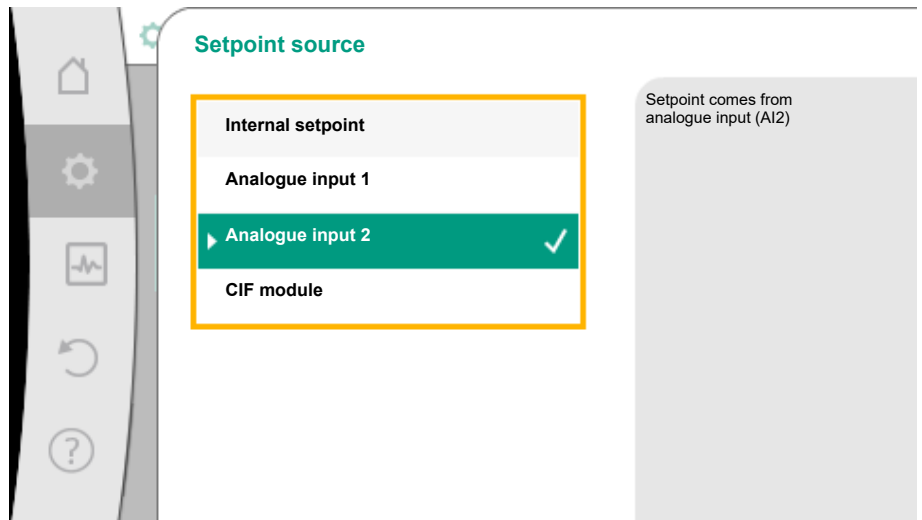

Fig. 52: Setpoint source

The setpoint source should be configured when an analogue input is used as source. To do this, select “Set setpoint source”.

#### Set input for external setpoint

Select setpoint source

#### Set setpoint source

Substitute setpoint in the event of a cable break

Table 36: Set input for external setpoint

Possible selection of type of use to be adjusted:

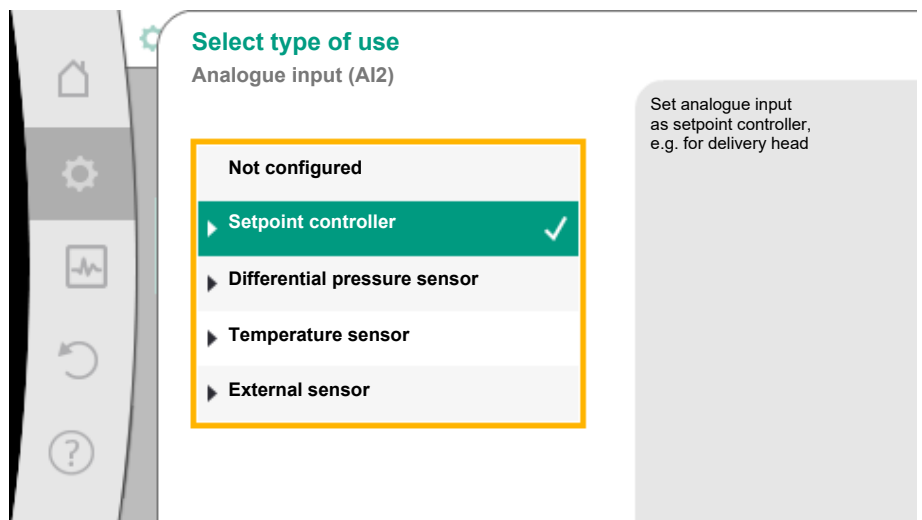

Fig. 53: Settings dialogue

Select “Setpoint sensor” as setpoint source.



#### NOTICE

If another usage type has been set to “Not configured” in the “Select type of use” menu, check whether the analogue input is already used for another type of use.  
If necessary, select a different source.

Select the “Signal type” after selecting the type of use:

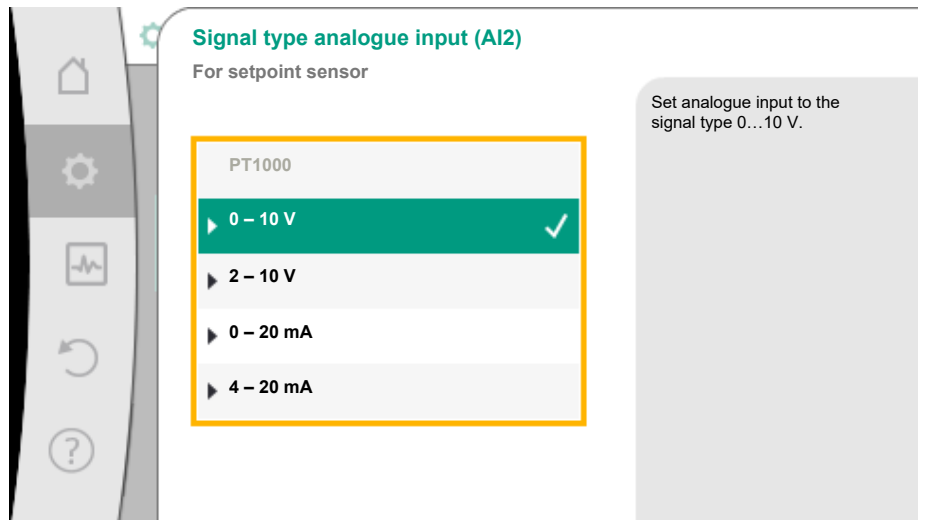

Fig. 54: Signal type

After selecting the signal type, it is defined how standard values are used:

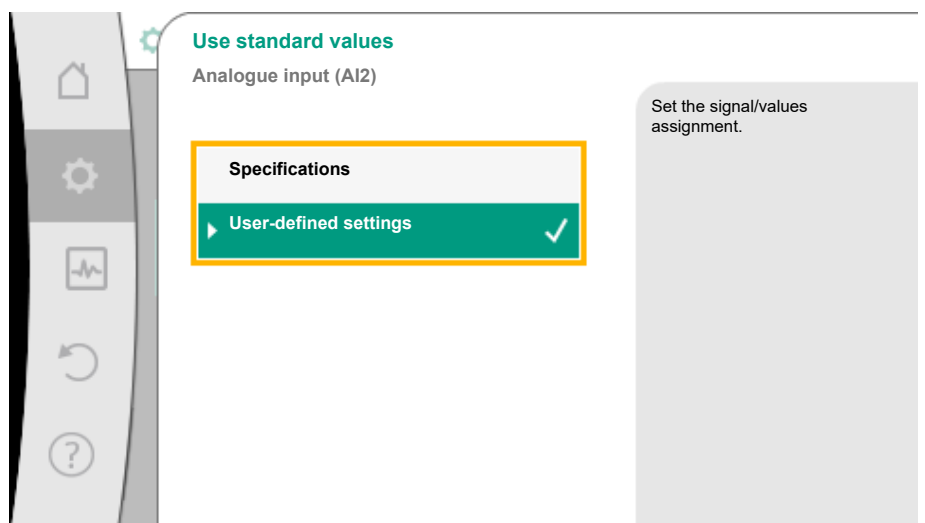

Fig. 55: Use standard values

Defined standards for the transfer of the signal are used with “Use specifications”. Finally the setting of the analogue input is ended as setpoint sensor.

#### Signal assignment for “Use specifications”

Signal type 0 – 10 V	
OFF:	1.0 V
ON:	2.0
Min:	3.0 V
Max:	10.0 V

Table 37: Standard signal assignment 0 – 10 V

Signal type 2 – 10 V	
Cable break detection	< 2.0 V
OFF:	2.5 V
ON:	3.0 V
Min:	3.0 V
Max:	10.0 V

Table 38: Standard signal assignment 2 – 10 V

Signal type 0 – 20 mA	
OFF:	2.0 mA
ON:	4.0 mA

Signal type 0 – 20 mA	
Min:	6.0 mA
Max:	20.0 mA

Table 39: Standard signal assignment 0 – 20 mA

Signal type 2 -- 20 mA	
Cable break detection	< 4.0 mA
OFF:	5.0 mA
ON:	6.0 mA
Min:	6.0 mA
Max:	20.0 mA

Table 40: Standard signal assignment 2 – 20 mA

Select “User-defined setting” to configure additional settings:

Optional cable break detection is available for 0 to 10 V and 0 to 20 mA signal types only.

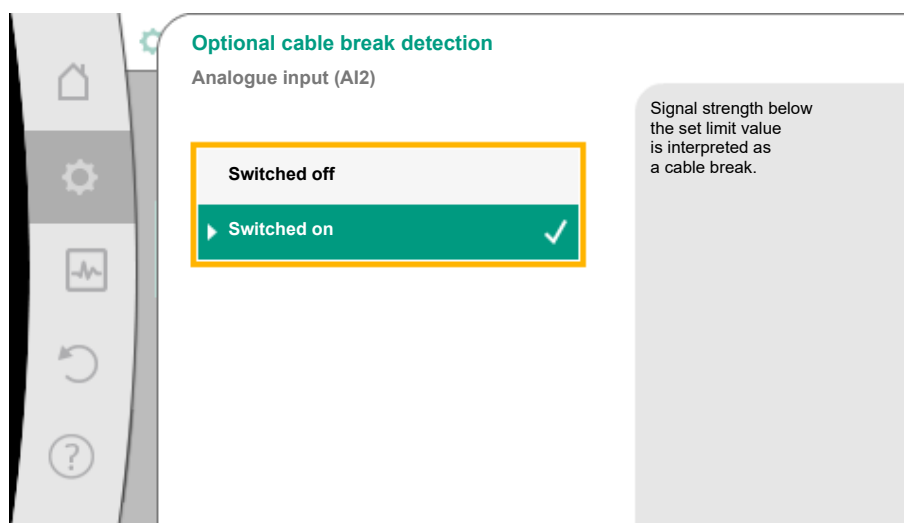

Fig. 56: Optional cable break detection

Select “Switched off” to switch off cable break detection.

Select “Switched on” to activate cable break detection only within an adjustable limit value.

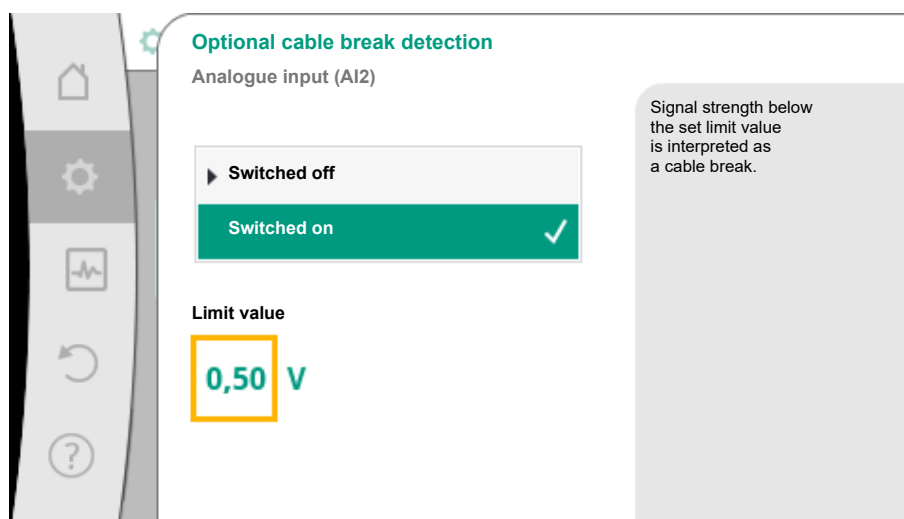

Fig. 57: Cable break limit value

Define limit value for cable break by turning the control knob and confirm by pressing it.

In the next step define whether

- the analogue signal only changes the setpoint
- and the pump is additionally switched off through the analogue signal.

A setpoint change can be done through analogue signals without switching on and off the pump through the signals. In this case, “Switched off” is selected.

If the “On/off through analogue signal” function is switched on, the limit values must be

defined for switching on/off.  
Subsequently, assign the MIN signal/value and MAX signal/value.

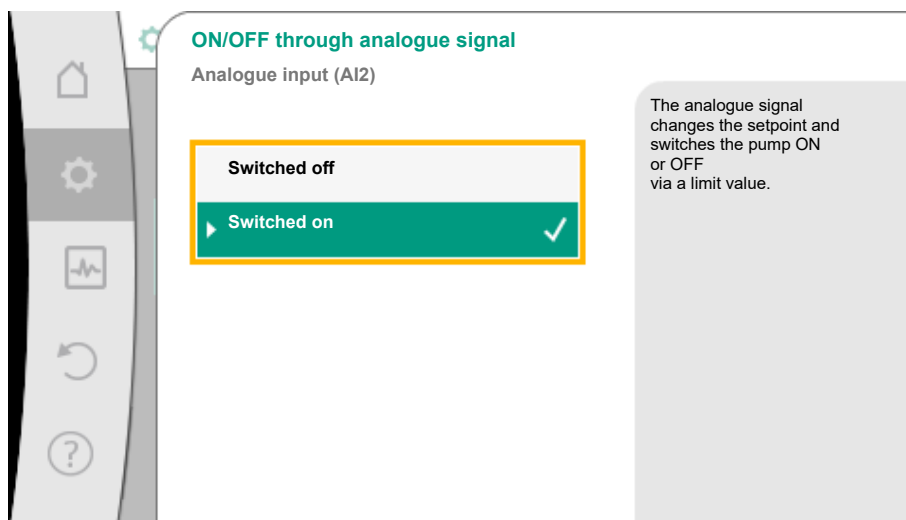

Fig. 58: ON/OFF through analogue signal

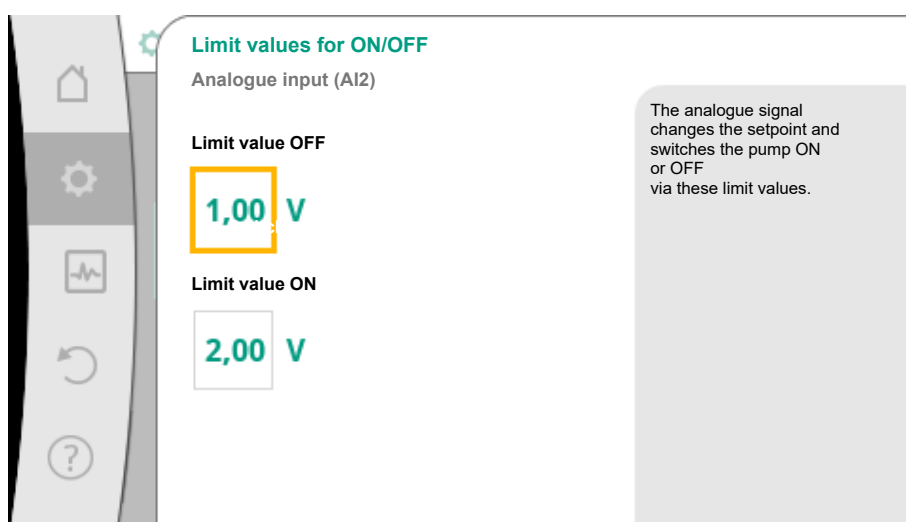

Fig. 59: Limit values for ON/OFF control through analogue signal

For the transfer of analogue signal values to setpoints, only the transfer ramp is now defined. For this purpose, the minimum and maximum support points of the characteristic curve are specified and the respective setpoints are amended (MIN signal/value assignment and MAX signal/value assignment).

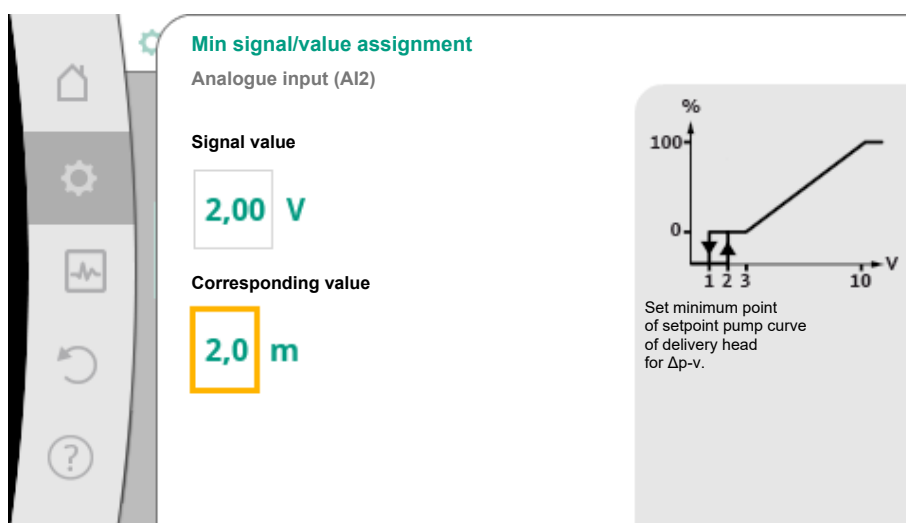

Fig. 60: Minimum signal/value assignment

The value for the minimum signal describes the lower signal value of the transfer ramp with an associated value of 2 m. In this example, the lower signal value is 2 V.

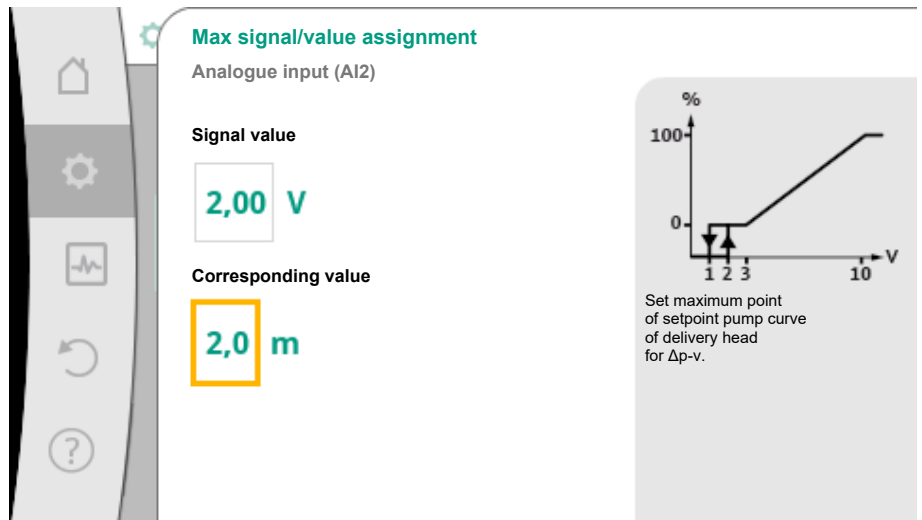

Fig. 61: Max. signal/value assignment

The value for the maximum signal describes the upper signal value of the transfer ramp with an associated value of 8 m. In this example, the lower signal value is 10 V.

When all signal/value assignments have been performed, the setting of the analogue setpoint source is completed.

An editor for adjusting the substitute setpoint in the event of a cable break or wrong configuration of the analogue input will open.

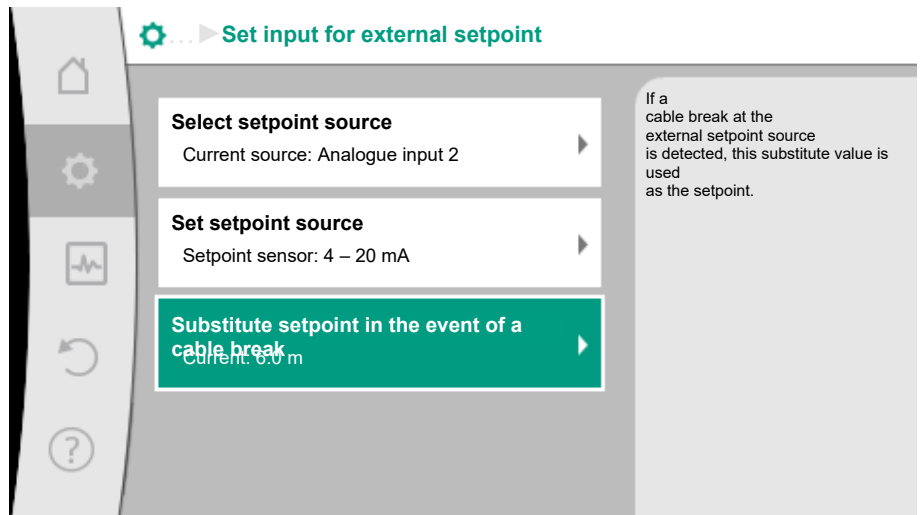

Fig. 62: Substitute setpoint in the event of a cable break

Select substitute setpoint. This setpoint is used when detecting a cable break at the external setpoint source.

## 6.7.2 Actual value sensor configuration

### Actual value sensor

The actual value sensor provides:

- Temperature sensor values for temperature-dependent control modes:
  - Constant temperature
  - Differential temperature
  - Room temperature
- Temperature sensors values for temperature-dependent additional functions:
  - Heating/cooling quantity measurement
  - Automatic heating/cooling switchover
  - Automatic detection of thermal disinfection
- Differential pressure sensor values for:
  - Differential pressure control with index circuit actual value logging
- User-defined sensor values for:
  - PID control

Possible signal types when selecting the analogue input as actual value input:

### Actual value sensor signal types:



**0 – 10 V:** voltage range of 0 to 10 V for transfer of measurement values.

**2 – 10 V:** voltage range of 2 to 10 V for the transfer of measurement values. Cable break is detected for a voltage below 2 V.

**0 – 20 mA:** electric current range of 0 to 20 mA for transfer of measured values.

**4 – 20 mA:** electric current range of 4 to 20 mA for transfer of measured values. A cable break is detected in case of electric current below 4 mA.

**PT1000:** The analogue input evaluates a PT1000 temperature sensor.

### Actual value sensor configuration



#### NOTICE

The selection of the analogue input as a connection for a sensor requires the corresponding configuration of the analogue input.

First open the overview menu to view the current configuration and use of analogue input.

To do this, in the “Settings” menu , select

1. “External interfaces”
2. “Function analogue input AI1” or “Function analogue input AI2”
3. “Overview of the analogue input”.

Type of use, signal type and other set values for selected analogue input will be displayed. In order to make or change settings:

In the “Settings” menu , select

1. “External interfaces”
2. “Function analogue input AI1” or “Function analogue input AI2”
3. “Set analogue input”.

First select type of use:

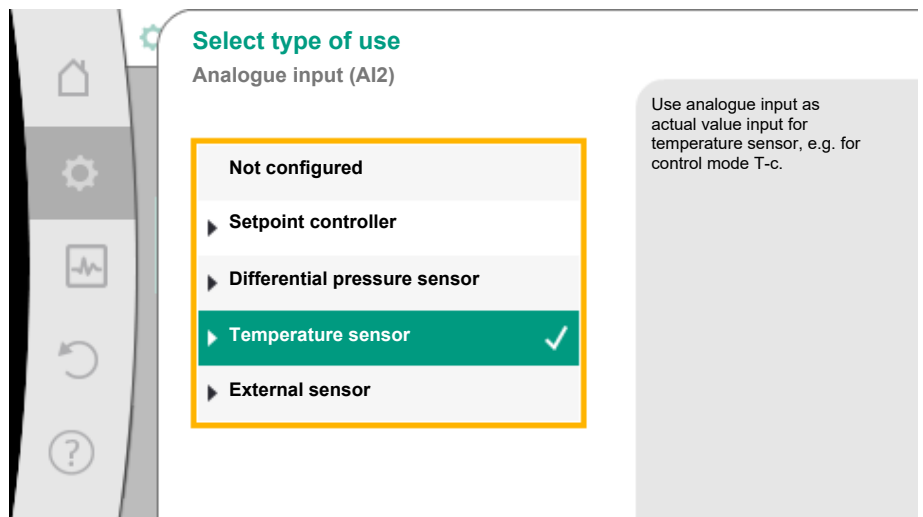

Fig. 63: Settings dialogue actual value sensor

Select one of the types of use “Differential pressure sensor”, “Temperature sensor” or “External sensor” as one of the usage types.



#### NOTICE

If another usage type has been set to “Not configured” in the “Select type of use” menu, check whether the analogue input is already used for another type of use. If necessary, select a different source.

Select the “Signal type” after selecting the actual value sensor:

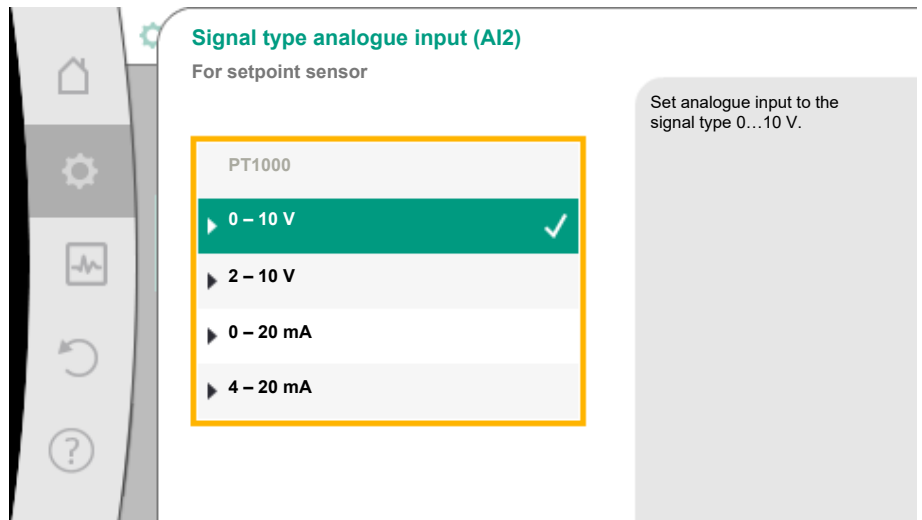

Fig. 64: Signal type

When selecting the signal type “PT1000”, all settings for the sensor input are completed and all other signal types require additional settings.

For the transfer of analogue signal values to actual values, only the transfer ramp is now defined. For this purpose, the minimum and maximum support point of the characteristic curve is specified and the respective actual values are amended (MIN signal/value assignment and MAX signal/value assignment).



## NOTICE

If the analogue input has been configured to the signal type PT1000 for a temperature sensor, a “temperature correction value” can be set to compensate for the electrical resistance if the sensor cable is longer than 3 m.

The temperature correction value in Kelvin (K) can be set in the range of +/-15 K.

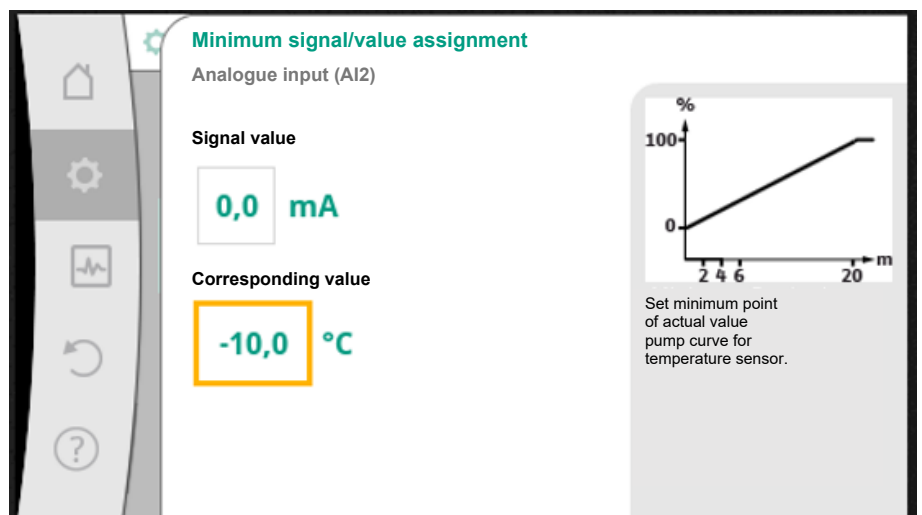

Fig. 65: Minimum signal/value assignment, actual value sensor

The value for the minimum signal describes the lower signal value of the transmission ramp with an associated value of 0 %. This is the equivalent of 0.0 mA for -10 °C in this example.

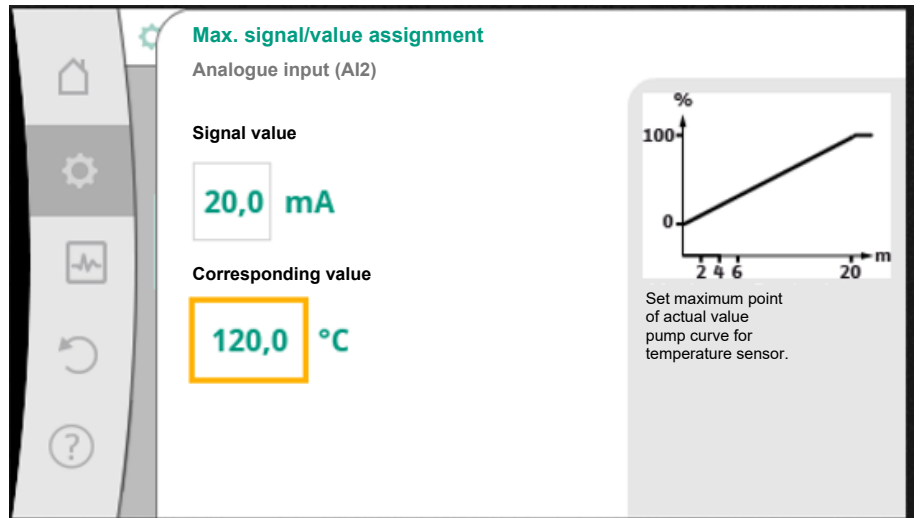

Fig. 66: Maximum signal/value assignment, actual value sensor

Data input is complete once the minimum and maximum characteristic curve support points have been entered.

The value for the maximum signal describes the upper signal value of the transmission ramp with an associated value of 100 %. This is the equivalent of 20.0 mA for 120 °C in this example



#### NOTICE

If the signal type PT1000 was selected, it is possible to set a temperature correction value for the measured temperature. With this the electrical resistance of a long sensor cable can be compensated. The temperature correction value in Kelvin (K) can be set in the range of +/-15° K.

In the "Settings" menu , select

1. "External interfaces"
2. "Function analogue input AI1" or "Function analogue input AI2"
3. "Temperature correction" and set correction value (offset).



#### NOTICE

Optionally specify the position of the sensor for better understanding of the connected sensor's function. This configured position does not influence the function or sensor use.

In the "Settings" menu , select

1. "External interfaces"
2. "Function analogue input AI1" or "Function analogue input AI2"
3. "Select the sensor position".

The following positions are available:

- Internal sensor
- Analogue input 1
- Analogue input 2
- BMS (Building management systems)
- Feed
- Return
- Primary circuit 1
- Primary circuit 2
- Secondary circuit 1
- Secondary circuit 2
- Accumulator
- Hall

## 6.8 Application and function of the Wilo Net interface

- Circulation

Wilo Net is a bus system which enables up to **21** Wilo products (participants) to communicate with one another.

### Application for:

- Generic twin-head pump
- Two-pump system consisting of two single pumps (Y-pipe installation)
- Multi-Flow Adaptation (feeder pump connected to secondary pumps)

### Bus topology:

The bus topology consists of multiple participants (pumps), which are switched on in sequence. The participants are connected to each other via a common cable.

The three Wilo Net terminals (H, L, GND) must be wired with a communication cable from pump to pump. Incoming and outgoing cables are clamped in a terminal.

The bus must be terminated at both ends of the line. This is done for the two external pumps in the pump menu. All other participants should **not** have activated termination.

All bus subscribers must be assigned an individual address (Wilo Net ID). This address is set in the pump menu of the respective pump.

To terminate the pumps:

In the “Settings” menu , select

1. “External interfaces”
2. “Wilo Net setting”
3. “Wilo Net termination”.

Possible selection:

Wilo Net termination	Description
Switched on	The termination resistor of the pump is switched on. If the pump is connected at the end of the electrical bus line, “Switched on” must be selected.
Switched off	The termination resistor of the pump is switched off. If the pump is NOT connected at the end of the electrical bus line, “Switched off” must be selected.

After termination is done, an individual Wilo Net address is assigned to the pumps:

In the “Settings” menu , select

1. “External interfaces”
2. “Wilo Net setting”
3. “Wilo Net address” and assign each pump its own address (1 to 20).

### Twin-head pump example:

- Pump head left (I)
  - Wilo Net termination: ON
  - Wilo Net address: 1
- Pump head right (II)
  - Wilo Net termination: ON
  - Wilo Net address: 2

### Number of Wilo Net participants

A maximum of 21 participants (from pump software SW 01.04.19.00) can communicate with each other in Wilo Net. Each individual node counts as a participant, i.e. a twin-head pump/two-pump system consists of two participants.



## NOTICE

If a Multi-Flow Adaptation system is made up of twin-head pumps, this means a maximum of 5 twin-head pumps can communicate with each other via Wilo Net in the MFA network. In addition to this maximum of 5 twin-head pumps, up to 10 additional single pumps can be included in the network.

### Other examples

The primary circuit pump of a Multi-Flow Adaptation system is a twin-head pump.

- Primary twin-head pump/two-pump system = 2 participants (e.g. ID 1 and ID 2)
- Accessories = 1 participant (e.g. ID 21)

A maximum of 18 pumps remain on the secondary side in the MFA system (ID 3 to 20). In the Wilo Net settings, the Wilo Net ID address space of 1 to 126 is displayed as adjustable.

However, only the ID address space of 1 to 21 is available for a functioning Wilo Net connection between pumps and accessories. A maximum of 21 participants can therefore communicate in Wilo Net.

Higher IDs mean that Wilo Net participants with higher IDs cannot communicate correctly with the other participants.

The smallest Wilo Net “communication network” consists of two participants (e.g. with twin-head pumps or two single pumps as two-pump system). Usually the participants are then operated with ID 1 and ID 2. However, any other combination of IDs 1 to 21 is possible as long as both IDs are different.



## NOTICE

When replacing a Wilo-Stratos MAXO pump with SW  $\geq$  01.04.19.00 in an existing Multi-Flow Adaptation system with pumps that have a lower SW version (SW  $<$  01.04.19.00), all integrated Wilo-Stratos MAXO pumps must be updated to a higher SW version (SW  $\geq$  01.04.19.00).

## 6.9 Application and function of CIF module

Depending on the inserted CIF module type, an associated settings menu is displayed in the menu:



“Settings”

1. “External interfaces” displayed.

The respective settings are described in the display and in the CIF module documentation.

## 7 Device settings

General settings are made under “Settings” , “Device settings”.

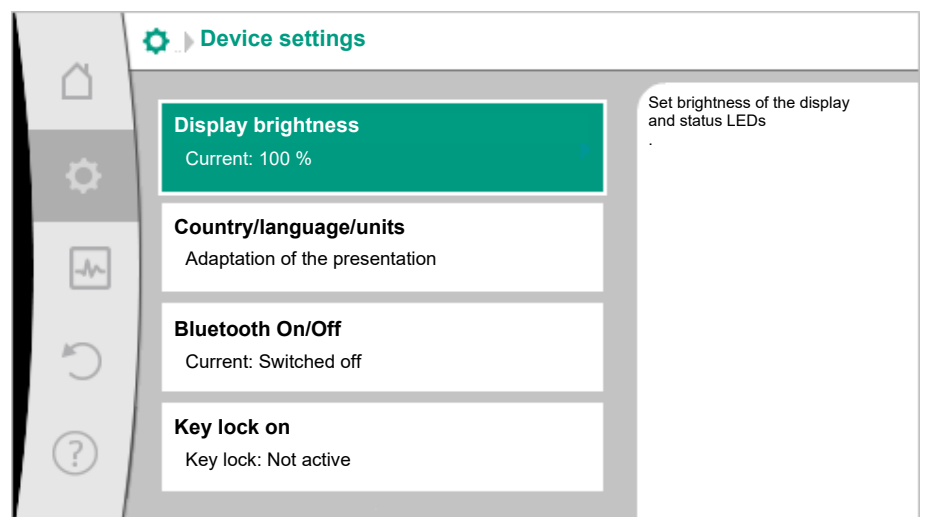

Fig. 67: Device settings

- Display brightness
- Country/language/units
- Bluetooth On/Off
- Key lock On
- Device information
- Pump kick

**7.1 Display brightness**

Under “Settings” 

1. “Device settings”
2. “Display brightness”

the display brightness can be changed. The level of brightness is shown in a percentage. 100 % brightness corresponds to maximum possible, 5 % is the minimum possible brightness.

**7.2 Country/language/units**

Under  “Settings”

1. “Device settings”
2. “Country/language/units”

you can set

- country
- language and
- units for physical values.

By selecting the country, the language is preset along with the physical units and the correct contact data for calling up the local customer service in the help menu. Choose from over 60 countries and 28 languages.

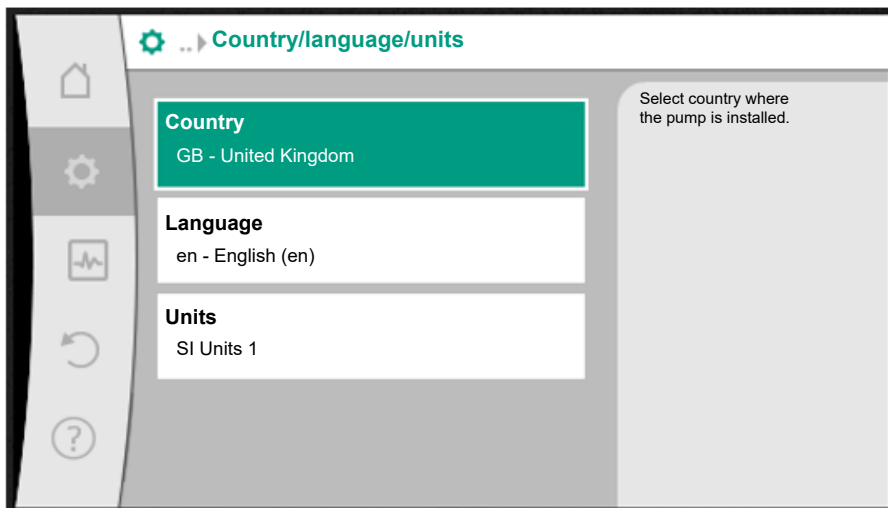

Fig. 68: Country/language/units

Selection options of units:

Units	Description
SI units 1	Representation of physical values in SI units. <b>Exception:</b> • Volume flow in m <sup>3</sup> /h • Delivery head in m
SI units 2	Display of the delivery head in kPa and the volume flow in m <sup>3</sup> / h
SI units 3	Representation of delivery head in kPa and volume flow in l/s
US units	• volume flow in USGPM • delivery head in ft

Table 41: Units



## NOTICE

Units are set to SI units 1 as a factory setting.  
For Stratos MAXO variants for the USA and Canada, the units are set to US units at the factory.

### 7.3 Bluetooth On/Off

Under  "Settings"

1. "Device settings"
2. "Bluetooth On/Off"

you can switch Bluetooth on or off. When Bluetooth is switched on, the pump can connect to other Bluetooth devices (e.g., smartphone with Wilo-Assistant app and the Smart connect function it has).

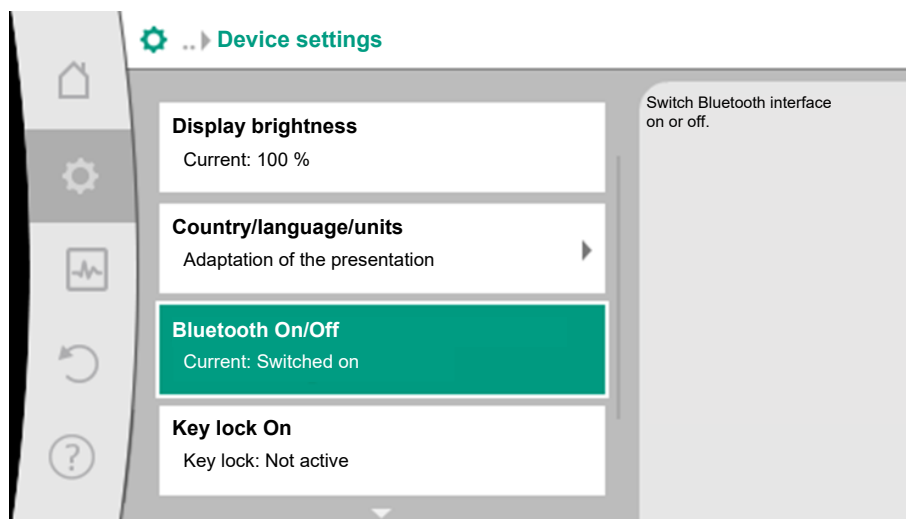

Fig. 69: Bluetooth On/Off



## NOTICE

Bluetooth is switched on as a factory setting.

### 7.4 Key lock on

The key lock function prevents accidental change of pump parameters by unauthorised persons.

Under  "Settings"

1. "Device settings"
  2. "Key lock On"
- you can activate the key lock.

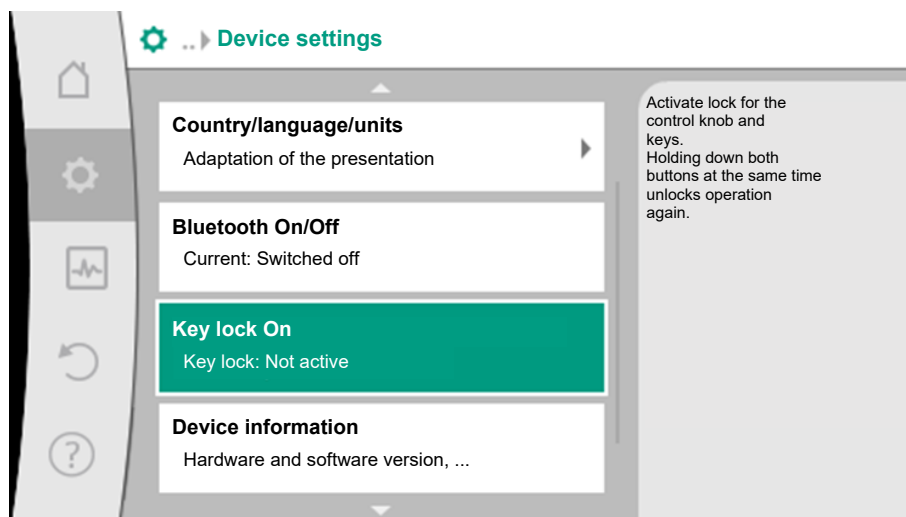

Fig. 70: Key lock On

Simultaneously pressing (> 5 seconds) “Back”  and “Context”  button deactivates the key lock.



## NOTICE

You can also lock the keys using the digital inputs DI 1 and DI 2 (see the “Application and function of the digital control inputs DI1 and DI2 [▶ 61]” section).

If the key lock was activated through digital inputs DI 1 or DI 2, the deactivation can be done only through the digital inputs! A button combination is not possible!

The home screen and warning as well as error messages are also displayed when the key lock is active so you can monitor the pump status.

A lock symbol  on the home screen indicates an activated key lock.

The active key lock is displayed on the LED display as follows for 3 seconds:



Then the display switches back to the previous screen.

## 7.5 Device information

Under  “Settings”

1. “Device settings”
2. “Device information”

you can read information about product names, the product and serial number as well as software and hardware version.

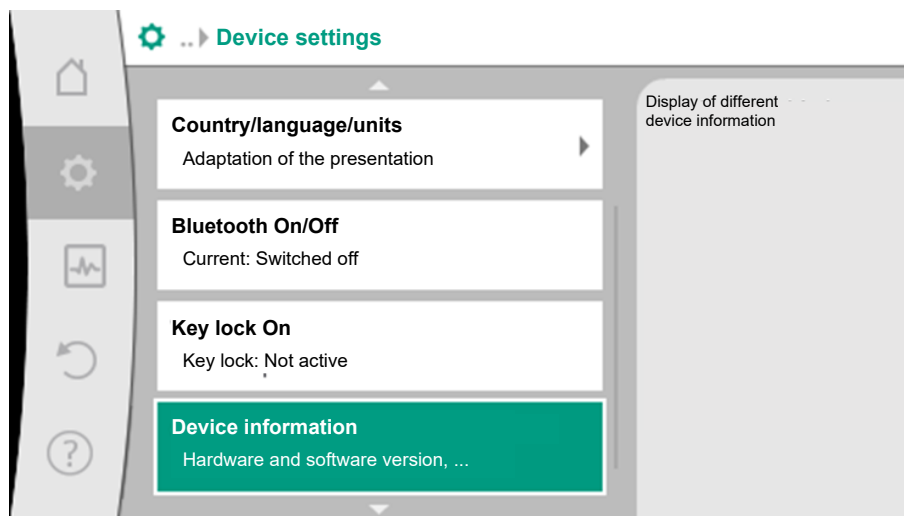

Fig. 71: Device settings



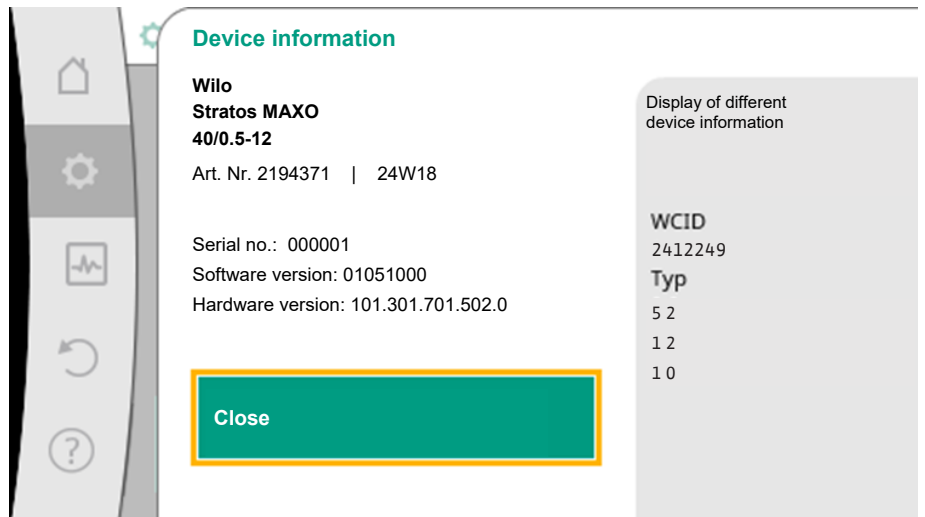

Fig. 72: Device information

## 7.6 Pump kick

In the “Settings” menu 

1. “Device settings”
2. “Pump kick”
  - the pump kick can be switched on and off and the time interval can be set.

For further details on the pump kick, see “Pump kick” [► 52] section.

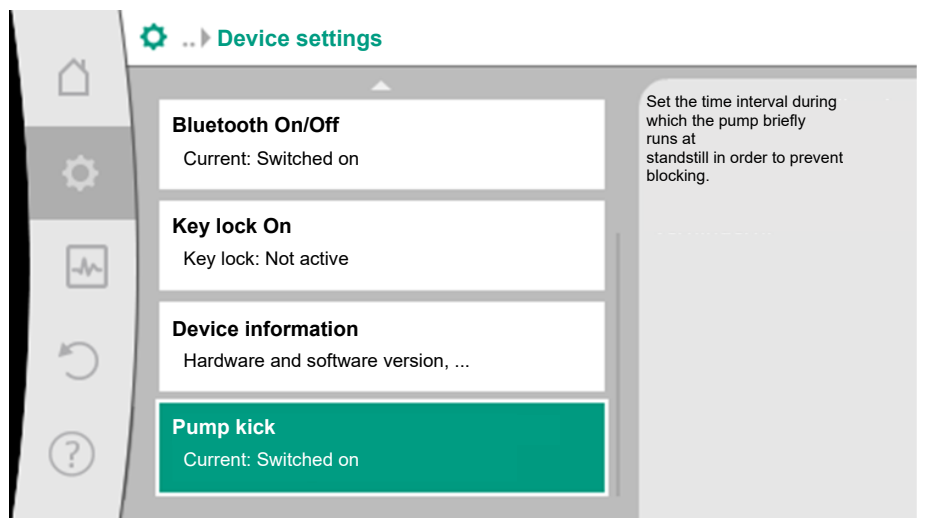





Fig. 73: Pump kick

## 8 Help

### 8.1 Help system

In the “Help” menu 

1. “Help System”

you can find a lot of basic information, which will help you to understand the product and its functions better. By pressing the Context button , you can access more information about the displayed topics. Going back to the previous help page is possible at any time by pressing the Context button  and selecting “back”.

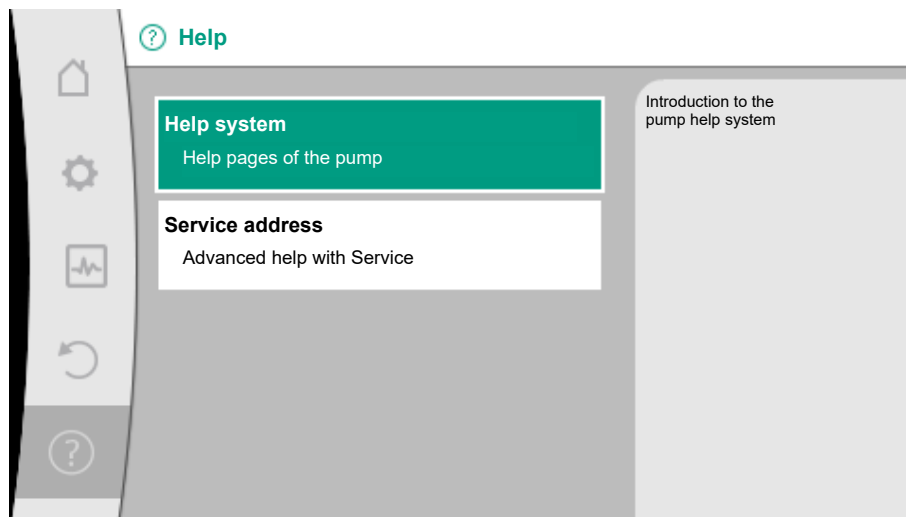

Fig. 74: Help system

## 8.2 Service contact

For questions about the product and in case of problems, the contact details of the factory customer service can be found at

“Help” 

1. “Service address”.

The contact data is dependent on the country setting in “Country, language, units” menu. Only local addresses are mentioned for each country.

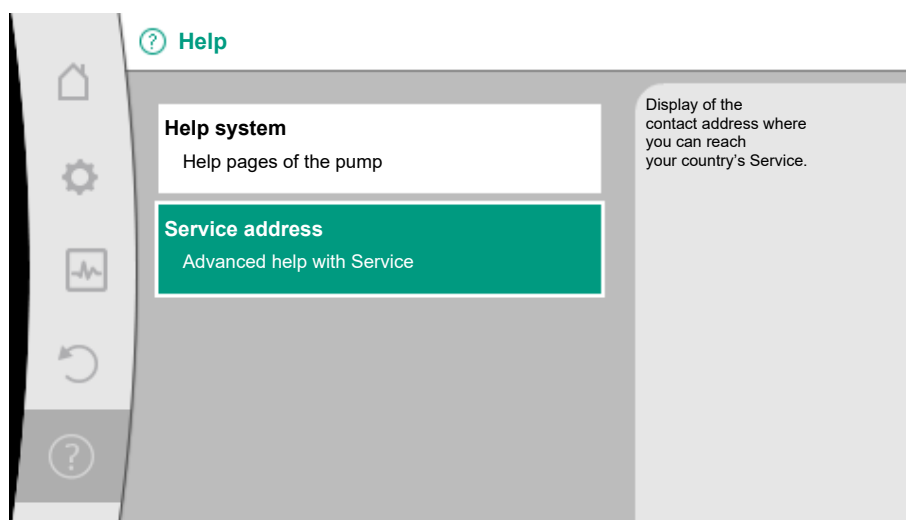

Fig. 75: Service address

## 8.3 Diagnostics help

In order to support fault analysis, the pump provides additional help apart from fault notifications:

Diagnostics help is used for diagnosis and maintenance of electronics and interfaces. Apart from hydraulic and electrical overviews, information about interfaces, device information and manufacturer’s contact data are provided.

In the “Diagnostics and measured values” menu , select

1. “Diagnostics help”.

Selection options:

Diagnosics help	Description	Display
Overview of hydraulic data	Overview of current hydraulic operating data.	<ul style="list-style-type: none"> <li>• Actual delivery head</li> <li>• Actual volume flow</li> <li>• Actual speed</li> <li>• Actual fluid temperature</li> </ul> <ul style="list-style-type: none"> <li>• Active restriction</li> </ul> Example: max. pump characteristic curve
Overview of electrical data	Overview of current electrical operating data.	<ul style="list-style-type: none"> <li>• Mains voltage</li> <li>• Power consumption</li> <li>• Consumed energy</li> </ul> <ul style="list-style-type: none"> <li>• Active restriction</li> </ul> Example: max. pump characteristic curve
Overview of the analogue input (AI 1)	Overview of settings e.g. type of use of temperature sensor, signal type PT1000 for control mode T-const	<ul style="list-style-type: none"> <li>• Type of use</li> <li>• Signal type</li> <li>• Function<sup>1)</sup></li> </ul>
Overview of the analogue input (AI 2)	e.g. type of use of temperature sensor, signal type PT1000 for control mode $\Delta T$ -const	<ul style="list-style-type: none"> <li>• Type of use</li> <li>• Signal type</li> <li>• Function<sup>1)</sup></li> </ul>
SSM relay forced control	Forced control of the SSM relay in order to check the relay and electrical connection.	<ul style="list-style-type: none"> <li>• Normal</li> <li>• Forced active</li> <li>• Forced inactive<sup>2)</sup></li> </ul>
SBM relay forced control	Forced control of the SBM relay, in order to check the relay and electrical connection.	<ul style="list-style-type: none"> <li>• Normal</li> <li>• Forced active</li> <li>• Forced inactive<sup>2)</sup></li> </ul>
Device information	Display of different device information.	<ul style="list-style-type: none"> <li>• Pump type</li> <li>• Article number</li> <li>• Serial number</li> <li>• Software version</li> <li>• Hardware version</li> </ul>
Manufacturer contact	Display of contact data of the factory customer service.	<ul style="list-style-type: none"> <li>• Contact data</li> </ul>

Table 42: Selection options – Diagnostics help

<sup>1)</sup> For information about type of use, signal type and functions, see the “Application and function of the analogue inputs AI1 and AI2 [► 63]” section.

<sup>2)</sup> See the “SSM-/SBM relay forced control [► 61]” section.

## 9 Error messages

### Displays an error message on the display

- The status display will be in red colour.
- Error message, error code (E...), cause and remedy are described as text.

### Error messages displayed on the LED display with seven segments

- An error code (E...) is displayed.



Fig. 76: Error code display

**The pump is not operational if an error has occurred. If the pump identifies as part of permanent monitoring that the cause of the error no longer applies, the error message is revoked and operation resumes.**

If an error message is output, the display is permanently on and the green LED indicator is off.

Code	Fault	Cause	Remedy
401	Unstable power supply	Unstable power supply.	Check power supply.
	Additional information about causes and remedy: Power supply too unstable. Operation cannot be maintained.		
402	Undervoltage	Power supply is too low.	Check power supply.
	Additional information about causes and remedy: Operation cannot be maintained. Possible causes 1. Mains overloaded 2. Pump is connected to the wrong power supply 3. Three-phase power supply is unsymmetrically loaded by unevenly connected single-phase consumers.		
403	Overvoltage	Power supply is too high.	Check power supply.
	Additional information about causes and remedy: Operation cannot be maintained. Possible causes: 1. Pump is connected to the wrong power supply 2. Three-phase power supply is unsymmetrically loaded by unevenly connected single-phase consumers.		
404	Pump blocked.	Mechanical influence is inhibiting the rotation of the pump shaft.	Check free movement of rotating parts in the pump head and motor. Remove deposits and foreign substances.
	Additional information about causes and remedy: In addition to deposits and foreign bodies in the system, the pump shaft can also be tilted and blocked by heavy bearing wear.		
405	Electronic module too hot.	Permissible temperature of the electronic module is exceeded.	Ensure permissible ambient temperature. Improve room ventilation.
	Additional information about causes and remedy: Adhere to permissible installation position and minimum distance from insulation and system components to ensure sufficient ventilation.		
406	Motor too hot.	Permissible motor temperature is exceeded.	Ensure permissible ambient and fluid temperature. Ensure motor cooling with unobstructed air circulation.
	Additional information about causes and remedy: Adhere to permissible installation position and minimum distance from insulation and system components to ensure sufficient ventilation.		
407	Connection between motor and module interrupted.	Electrical connection between motor and module faulty.	Check the motor module connection.
	Additional information about causes and remedies: Dismantle the electronic module to check the contacts between module and motor.		

Code	Fault	Cause	Remedy
408	There is flow through the pump in the opposite direction of flow.	External influences cause flow through against direction of flow of the pump.	Check power control of the pumps, install swing check valve if needed.
	Additional information about causes and remedy: If flow passing through pump in the opposite direction is too strong, the motor can no longer start.		
409	Incomplete software update.	The software update was not completed.	Software update with a new software bundle is required.
	Additional information about causes and remedy: The pump can work only once the software update has been completed.		
410	Analogue / digital input overloaded.	Voltage of analogue / digital input short-circuited or too heavily loaded.	Check cable and consumers connected to power supply of analogue / digital input for short-circuit.
	Additional information about causes and remedy: The fault impairs the binary inputs. EXT. OFF is set. The pump is stationary. The power supply is the same for analogue and digital input. In case of over-voltage, both inputs are overloaded equally.		
420	Motor or electronic module defective.	Motor or electronic module defective.	Replace motor and/or electronic module.
	Additional information about causes and remedy: The pump cannot determine which of the two components is faulty. Contact service.		
421	Electronic module is defective.	Electronic module is defective.	Replace electronic module.
	Additional information about causes and remedy: Contact service.		

Table 43: Error messages

## 10 Warning messages

### Warning displayed:

- The status display is marked in yellow.
- Warning message, warning code (W...), cause and remedy are described as text.

### Display of a warning in 7-segment LED display:

- The warning is displayed with a red coloured warning code (H...).



Fig. 77: Warning code display

**Warnings indicate restricted pump function. The pump continues to operate in restricted mode (emergency operation).**

**Depending on the cause of the warning, emergency operation leads to a restriction of the control function and even reactivation of a fixed speed.**

**If the pump identifies as part of permanent monitoring that the cause of the warning no longer applies, the warning is revoked and operation resumes.**

If there is a warning message, the display is permanently on and the green LED indicator is off.

Behaviour and display in the event of a warning message.

**Case 1: Display is in standby mode (display switches off after 2 mins if there is no operation).**

- If an event occurs during this time that results in a warning message, the display switches on. An orange warning triangle is displayed in the top left-hand corner of the home screen.
- If the warning is not cancelled or resolved, the view switches from the home screen to the warning message screen after 20 minutes.

**Case 2: Display is switched on, settings are configured. In the meantime, a warning occurs (e.g. warning due to a configuration error).**

- The display remains on and the green LED indicator goes out. If the warning is not cancelled or resolved, the view switches from the home screen to the warning message screen after 20 minutes.



**NOTICE**

If the back button is pressed for longer than 2 seconds or the control knob is pressed (within the 20 minutes), the warning message is shown in large on the display.

Code	Fault	Cause	Remedy
550	There is flow through the pump in the opposite direction of flow.	External influences cause flow through against direction of flow of the pump.	Check power control of the pumps, install swing check valve if needed.
	Additional information about causes and remedy: If flow passing through pump in the opposite direction is too strong, the motor can no longer start.		
551	Undervoltage	Power supply has dropped below 195 V.	Check power supply.
	Additional information about causes and remedy: The pump is running. Undervoltage reduces the pump output. If the voltage falls below 160 V, the reduced operation cannot be maintained.		
552	There is externally generated flow through the pump in the direction of flow.	External influences cause flow through in the pump's direction of flow.	Check power control of the other pumps.
	Additional information about causes and remedy: The pump can start despite flow through.		
553	Electronic module is defective.	Electronic module is defective.	Replace electronic module.
	Additional information about causes and remedy The pump is running, but cannot provide full power under the circumstances. Contact service.		
554	MFA <sup>1)</sup> pump is not reachable.	An MFA <sup>1)</sup> partner pump no longer reacts to requests.	Check Wilo Net connection or power supply of the partner pump.
	Additional information about causes and remedy In the MFA <sup>1)</sup> overview, check the pump highlighted with (!). The supply is ensured, a substitute value is assumed.		
555	No plausible sensor value at analogue input AI 1.	The configuration and the present signal lead to an unusable sensor value.	Check configuration of the input and connected sensor.
	Additional information about causes and remedy Incorrect sensor values may lead to substitute operation modes that ensure functioning of the pump without the required sensor value.		
556	Cable break at analogue input AI 1.	The configuration and the present signal help identify the cable break.	Check configuration of the input and connected sensor.
	Additional information about causes and remedy: Cable break detection may lead to substitute operation modes that ensure functioning of the pump without the required external value.		

Code	Fault	Cause	Remedy
557	No plausible sensor value at analogue input AI 2.	The configuration and the present signal lead to an unusable sensor value.	Check configuration of the input and connected sensor.
	Additional information about causes and remedy Incorrect sensor values may lead to substitute operation modes that ensure functioning of the pump without the required sensor value.		
558	Cable break at analogue input AI 2.	The configuration and the present signal help identify the cable break.	Check configuration of the input and connected sensor.
	Additional information about causes and remedy: Cable break detection may lead to substitute operation modes that ensure functioning of the pump without the required external value.		
559	Electronic module too hot.	Permissible temperature of the electronic module is exceeded.	Ensure permissible ambient temperature. Improve room ventilation.
	Additional information about causes and remedy: Limited operation of the pump to avoid damage to the electronic components.		
560	Incomplete software update.	The software update was not completed.	Software update with new software bundle is recommended.
	Additional information about causes and remedy: Software update was not carried out; pump continues to operate with previous software version.		
561	Analogue input overloaded (binary).	Voltage analogue input short-circuited or too heavily loaded.	Check the cables and consumers connected to the analogue input power supply for short circuits.
	Additional information about causes and remedy: Binary inputs are impaired. Functions of binary inputs are not available.		
562	Analogue input overloaded (analogue).	Voltage analogue input short-circuited or too heavily loaded.	Check the cables and consumers connected to the analogue input power supply for short circuits.
	Additional information about causes and remedy: Analogue input functions impaired.		
563	Sensor value missing from BMS.	Sensor source or BMS is configured incorrectly. Communication has failed.	Check configuration and function of BMS.
	Additional information about causes and remedy: Control functions impaired. A replacement function is active.		
564	Setpoint missing from BMS.	Sensor source or BMS is configured incorrectly. Communication has failed.	Check configuration and function of BMS.
	Additional information about causes and remedy: Control functions impaired. A replacement function is active.		
565	Signal too strong to analogue input AI 1.	The available signal is significantly over the expected maximum.	Check input signal.
	Additional information about causes and remedy: The signal is processed with the maximum value.		

Code	Fault	Cause	Remedy
566	Signal too strong to analogue input AI 2.	The available signal is significantly over the expected maximum.	Check input signal.
	Additional information about causes and remedy: The signal is processed with the maximum value.		
569	Configuration missing.	Pump configuration is missing.	Configure pump. Software update is recommended.
	Additional information about causes and remedy: Pump operating in substitute operation mode.		
570	Electronic module too hot.	Permissible temperature of the electronic module is exceeded.	Ensure permissible ambient temperature. Improve room ventilation.
	Additional information about causes and remedies: The electronic module must adjust the pump's operation in the event of noticeable overheating to prevent damage to electronic components.		
571	Twin-head pump connection interrupted.	The connection to the dual-pump partner cannot be established.	Check power supply of the dual-pump partner, cable connection and configuration.
	Additional information about causes and remedy: Pump function slightly impaired. The motor head meets the pump function up to the performance limit.		
572	Dry run detected.	The pump has detected power consumption that is too low.	Check water pressure, valves and swing check valves.
	Additional information about causes and remedy: The pump is not conveying any fluid or only very little fluid.		
573	Communication to the display operating unit interrupted.	Internal communication to display and operating unit interrupted.	Check/clean contacts in the terminal room as well as on the display and operating unit.
	Additional information about causes and remedy: The display and operating unit is connected to the pump via 4 contacts on the edge of the opened terminal room.		
574	Communication to CIF module interrupted.	Internal communication to the CIF module interrupted.	Check/clean contacts between CIF module and electronic module.
	Additional information about causes and remedy: The CIF module is connected to the pump in the terminal room via four contacts.		
575	Remote control is not possible by radio.	The Bluetooth radio module is faulty.	Software update is recommended. Contact Service.
	Additional information about causes and remedy: Pump function not impaired. If a software update does not eliminate the issue, contact Service.		
576	Communication with Wilo sensor interrupted.	Internal communication with Wilo sensor interrupted.	Check the sensor cable and the Wilo-Connector sensor connector. The warning can only be reset if the pump is disconnected from the power supply and re-connected.
	Additional information about causes and remedy: The pump function is slightly impaired. The pump can no longer determine the internal fluid temperature.		



Code	Fault	Cause	Remedy
577	Software update cancelled.	The software update was not completed.	Software update with new software bundle is recommended.
	Additional information about causes and remedy: Software update was not carried out; pump continues to operate with previous software version.		
578	Display and operating unit defective.	A fault in the display and operating unit has been identified.	Replace display and operating unit.
	Additional information about causes and remedy: The display and operating unit is available as a spare part.		
579	Software for display and operating unit incompatible.	Display and operating unit cannot communicate correctly with the pump.	Software update is recommended.
	Additional information about causes and remedy: Pump function not impaired. If a software update does not eliminate the issue, contact Service.		
580	Too many wrong PIN entries.	Too many connection attempts with wrong PIN.	Disconnect power supply from the pump and switch it on again.
	Additional information about causes and remedy: An incorrect PIN has been entered more than 5 times. For safety reasons, further connection attempts are prevented without a restart.		
581	Fluid temperature unknown.	Temperature sensor is defective.	Replace temperature sensor.
	Additional information about causes and remedy: The pump works in a substitute operation mode that maintains pump operation.		
582	Twin-head pump is not compatible.	Dual-pump partner is not compatible with this pump.	Select/install appropriate dual-pump partner.
	Additional information about causes and remedy: Dual-pump function is only possible with two compatible pumps of the same type.		
583	Fluid temperature too high.	The fluid temperature is hotter than 110 °C.	Reduce fluid temperature.
	Additional information about causes and remedy: High fluid temperatures lead to significant damage to the pump.		
584	Internal fault in display and operating unit. Automatic reactivation of the display follows.		Contact service. Replace display and operating unit.
	Additional information about causes and remedies: The basic pump functions are not impacted by this fault.		
590	MFA <sup>1)</sup> partner type is not appropriate.	An MFA <sup>1)</sup> partner does not have the appropriate type.	Check type and software of the partner pump.
	Additional information about causes and remedy: A maximum replacement flow is provided for the Multi-Flow Adaptation partner. Check the partners highlighted with (!) in the MFA <sup>1)</sup> overview of the context menu.		

Table 44: Warning messages

<sup>1)</sup> MFA= Multi-Flow Adaptation

## 11 Configuration warnings

Configuration warnings occur if an incomplete or contradictory configuration has been made.

### Example:

The “Hall temperature control” function requires a temperature sensor. The corresponding source is not specified or not correctly configured.

Code	Fault	Cause	Remedy
601	Setpoint source not suitably configured.	Setpoint is not connected to correct source. Input not suitably configured.	Configure source or select another source.
	The setpoint source is not correctly configured. In the context menu there is a link for configuring the setpoint source.		
602	Setpoint source not available.	Setpoint not connected to existing CIF module.	Insert CIF module. Activate CIF module.
	The setpoint source or the CIF module is not correctly configured. In the context menu there are links for configuration.		
603	Sensor source not suitably configured.	Sensor 1 is not connected to correct source. Input not suitably configured.	Configure source. Select other source.
	The sensor source is not correctly configured. In the context menu there is a link for configuring the sensor source.		
604	Same sensor source not possible.	Sensor sources are configured to the same source.	Configure a sensor source to another source.
	The sensor sources are not correctly configured. In the context menu there is a link for configuring the sensor sources.		
606	Sensor source not available.	Sensor value 1 is not connected to existing CIF module.	Insert CIF module. Activate CIF module.
	The sensor source or the CIF module is not correctly configured. In the context menu there are links for configuration.		
607	Sensor source not suitably configured.	Sensor 2 is not connected to correct source. Input not suitably configured.	Configure source or select another source.
	The sensor source is not correctly configured. In the context menu there is a link for configuring the sensor source.		
609	Sensor source not available.	Sensor value 2 is not connected to existing CIF module.	Insert CIF module. Activate CIF module.
	The sensor source or the CIF module is not correctly configured. In the context menu there are links for configuration.		
610	Sensor source not suitably configured.	Feed temperature sensor is not connected to correct source. Input not suitably configured.	Configure source to “temperature sensor” usage type or select another source.
	The sensor source is not correctly configured. In the context menu there is a link for configuring the sensor source.		
611	Same sensor source not possible.	Sensor sources for heat meter configured for the same source.	Configure one of the sensor sources for the heat meter to another source.
	The sensor sources are not correctly configured. In the context menu there is a link for configuring the sensor sources.		

Code	Fault	Cause	Remedy
614	Sensor source not available.	Feed temperature is not connected to existing CIF module.	Insert CIF module. Activate CIF module.
	The sensor source or the CIF module is not correctly configured. In the context menu there are links for configuration.		
615	Sensor source not suitably configured.	Return temperature sensor is not connected to correct source. Input not suitably configured.	Configure source to "temperature sensor" usage type or select another source.
	The sensor source is not correctly configured. In the context menu there is a link for configuring the sensor source.		
618	Sensor source not available.	Return temperature is not connected to existing CIF module.	Insert CIF module. Activate CIF module.
	The sensor source or the CIF module is not correctly configured. In the context menu there are links for configuration.		
619	Sensor source not suitably configured.	Temperature sensor for "Heating/cooling switchover" is not connected to the correct source. Input not suitably configured.	Configure source to "temperature sensor" usage type or select another source.
	The sensor source is not correctly configured. In the context menu there is a link for configuring the sensor source.		
621	Sensor source not available.	Temperature value for "Heating/cooling switchover" is not connected to existing CIF module.	Insert CIF module. Activate CIF module.
	The sensor source or the CIF module is not correctly configured. In the context menu there are links for configuration.		
641	Setpoint source not suitably configured.	Setpoint is not connected to correct source. Input not suitably configured.	Configure source or select another source.
	The setpoint source for the cooling function is not correctly configured. In the context menu there is a link for configuring the setpoint source.		
642	Setpoint source not available.	Setpoint not connected to existing CIF module.	Insert CIF module. Activate CIF module.
	The setpoint source for the cooling function or the CIF module is not correctly configured. In the context menu there are links for configuration.		
643	Sensor source not suitably configured.	Sensor 1 is not connected to correct source. Input not suitably configured.	Configure source. Select other source.
	The sensor source for the cooling function is not correctly configured. In the context menu there is a link for configuring the sensor source.		
644	Same sensor source not possible.	Sensor sources are configured to the same source.	Configure a sensor source to another source.
	The sensor sources for the cooling function are not correctly configured. In the context menu there is a link for configuring the sensor sources.		

Code	Fault	Cause	Remedy
646	Sensor source not available.	Sensor value is not connected to existing CIF module.	Insert CIF module. Activate CIF module.
	The sensor source or the CIF module is not correctly configured. In the context menu there are links for configuration.		
647	Sensor source not suitably configured.	Sensor 2 is not connected to correct source. Input not suitably configured.	Configure source or select another source.
	The sensor source for the cooling function is not correctly configured. In the context menu there is a link for configuring the sensor source.		
649	Sensor source not available.	Sensor value 2 is not connected to existing CIF module.	Insert CIF module. Activate CIF module.
	The sensor source or the CIF module is not correctly configured. In the context menu there are links for configuration.		
650	No MFA <sup>1)</sup> partner pump	MFA <sup>1)</sup> is selected, but no partner pump is configured.	Configuration of MFA <sup>1)</sup> partner pumps is required or select another control mode.
	MFA <sup>1)</sup> collects the requirement of configured partner pumps to supply in total. For this purpose, the partner pumps must be selected in the MFA <sup>1)</sup> configuration.		

Table 45: Configuration warnings

<sup>1)</sup>MFA= Multi-Flow Adaptation

## 12 Software update

### General

The Wilo-Smart connect function in the Wilo-Assistant app for smartphones or tables (iOS and Android devices) enables the Stratos MAXO to be monitored and operated both near and far using a modern app.

The connection to a Wilo-Smart connect compatible pump (e.g. Stratos MAXO) can be established via a wireless Bluetooth connection (local remote control).

Local remote control via Bluetooth does not require any additional technical components for the connection, e.g. IR-Stick or an adapter, because of the Bluetooth LE wireless standard used. Unlike IR communication, Bluetooth wireless technology has the advantage of not requiring a direct line of sight between the pump and operating device.

Although remote control works locally via Bluetooth even without an internet connection, there are also functions in this type of use that also require an internet connection to the Wilo-Smart Cloud:

- You need to log in to MyWilo to use it. The user is identified and data is synchronised with the Cloud. This ensures that all Smart connect data is still available if the mobile device is changed.
- PDF reports are created via a Cloud service. Reports are therefore only available when the app has internet access. If a report is to be generated from a pump at a location where there is no mobile internet or WIFI, the app records all the necessary data and produces the PDF report when an internet connection becomes available again.

### 12.1 Installing the Wilo-Smart connect function

The Wilo-Smart connect function is part of the Wilo-Assistant app and can be downloaded via the Apple App Store or the Google Play Store. The Wilo-Smart connect function is automatically installed with an update of the Wilo-Assistant app if the Wilo-Assistant app is already installed.

### 12.2 Starting the Wilo-Smart connect function

The Wilo-Assistant app has a Connectivity area where the Wilo-Smart connect function can be accessed.

You will be asked to log in with a "MyWilo" account the first time you use the app. Wilo-Smart connect uses this account to exchange data with the Wilo-Smart Cloud.

On the log-in screen, there is a link to create a new "MyWilo" account if required. The app will remember your log-in details after the first log-in. The user therefore does not have to log in again each time they open the app.

- 12.3 Preparing a Bluetooth connection** To connect a pump to the app via Bluetooth, click on the Bluetooth symbol. A list of pumps accessible via Bluetooth appears. In this list, the “status” of all pumps can be seen from the coloured markings, even without being paired to the pumps. This allows the operating status to be checked quickly.
- Green → all OK
  - Yellow → there is a warning (the pump is still running).
  - Rot → there is an error (the pump has stopped).
- In order to find out details about a warning or error condition, an authenticated connection to the pump in question must be established. In order to establish a connection to a certain pump, the list entry of the pump in question must be found in the installation. There are four options here:
1. In small installations, the type designation alone can be enough to identify the pump.
  2. A signalled warning or error message on the pump can also identify the correspondingly marked pump in the list.
  3. Stratos MAXO pumps may contain an identifier. The identifier is now displayed in the list as additional information under the type. In the delivery state, the identifier is identical to the type designation.
  4. In order to identify which pump is indicated by a list entry when there are many identical pumps in an installation, signalling can be activated on one of the listed pumps. To activate signalling, click on the arrow behind the pump entry in the list. The pump selected in this way then switches to a “Focus” mode. For the Stratos MAXO, the display turns largely blue and the blue LED under the display flashes.
- 12.4 Establishing a Bluetooth connection** Once the correct pump has been identified, the “Connect” button is enabled for the “focused” pump in the list. After clicking on the “Connect” button, the “Focus” signalling on the Stratos MAXO switches to PIN signalling. PIN signalling involves generating a random four-digit PIN and displaying it large on the display. It is usually possible to read this in typical installation situations without a ladder or similar. For other pumps that have retrofitted the Wilo-Smart connect functions with the Wilo-Smart IF module, no PIN is displayed. The PIN must be read from the Wilo-Smart IF module. If the pump has not yet been connected to the smartphone, a request is sent to the smartphone asking whether this pump should be paired. After a confirmation, the PIN is entered in the waiting input dialogue of the Wilo-Smart connect app. There is now a connection between the Wilo-Smart connect app and the pump.
- 12.5 Dashboard of the connected pump** The dashboard is the start screen of a connected pump. It appears after successful pairing. The dashboard provides access to the following menu sections:
- Messages/Error history
  - Monitoring
  - Settings
  - Documentation
  - Copying pump configuration
  - Diagrams
  - Setpoint overview
  - Updating pump software
- In addition, the dashboard provides a quick overview of any potential error messages. Pump name and location can also be entered under “Edit”.
- 12.6 Updating pump software** Available SW update versions and their SW release notes can be found in the “Update pump software” area of the dashboard.
- 12.7 Update firmware** The Wilo-Smart connect app offers the function to update the pump software of a Wilo-Stratos MAXO. For a pump software update, the update bundle for the pump must be present in the app before the connection to the pump is established. For this, the app must have been connected to the internet. The app checks the internet for availability of current software bundles for pumps. During an update, the app downloads the latest software for the pump. If the Bluetooth connection to a pump is established later, “**Update Firmware**” can be selected on the dashboard. The update process of the pump is started. The previously downloaded update bundle is used. This means that it’s also possible to update the pump at an installation site that doesn’t get Internet access. The update process can vary greatly in length depending on the software version of the

pump, the amount of changes in the update software and the connection quality. Transfer times of the update bundle may take just a few minutes or up to 2 hours.

Before the updated software elements are installed in the pump, the consistency of the transferred software is checked on the pump. The check lasts around 5 minutes.

During the SW transfer and the subsequent check, the pump continues to function. After the check, the distribution and installation of the new software to all system components of the pump is started. Among the components are:

- The pump logic itself (power electronics and control electronics)
- The temperature sensor (if present)
- The operating unit (display and operating elements)
- If applicable, an installed CIF module

The new software is installed for the pump logic first. The software is then rolled out for all other components.



## NOTICE

During distribution, the pump temporarily stops operation, and the display remains off for a maximum of 20 seconds. The entire internal software distribution can last up to a maximum of 2 minutes, during which the pump will also temporarily not be pumping.

Even if the operating unit has not yet been fully updated, the pump will resume pumping according to the previously set control.

When the operating unit has been updated with the new software, the display shows “**Loading files ...**” with a progress bar. This process can take up to 15 minutes. In this phase, the pump is fully functional and can be remotely controlled via the app again.

However, the operating unit is still installing the contents, some of which are very large and consist of language files for more than 25 languages and various graphics.

### 12.8 Software update for connected twin-head pumps

Updating the software for a twin-head pump is only possible if the twin-head pump is disconnected beforehand.

Both pump heads can then be controlled with the app like single pumps. The software update is carried out for each pump head. The twin-head pump connection is then restored.

## 13 Accessories

### 13.1 ClimaForm cold water insulation shell

Type-dependent, diffusion-proof cold water insulation shells (Wilo-ClimaForm) are available for use in cooling and air conditioning applications for Wilo-Stratos MAXO single pumps.

There are no prefabricated cold water insulation shells for twin-head pumps. For this purpose, use commercially available, diffusion-proof insulation materials provided by the customer.

### 13.2 PT1000 AA (immersion temperature sensor)

The immersion temperature sensor PT1000 AA for installation in an immersion sleeve is available for “heating and cooling” applications or for temperature-dependent control modes.

The PT1000 AA is connected to the Wilo-Stratos MAXO at one of the two analogue inputs AI1 or AI2, which have to be set to the connection type PT1000.

Technical data of the PT1000 AA:

- Tolerance class AA in accordance with DIN EN 60751
- Cable length 3 m

Tolerances PT1000 AA	
Temperature in °C	Accuracy in °C
10	+/- 0.117
20	+/-0.134
30	+/-0.151
40	+/-0.168
50	+/-0.185
60	+/-0.202

Tolerances PT1000 AA	
Temperature in °C	Accuracy in °C
70	+/-0.219
80	+/-0.236
90	+/-0.253

Table 46: Tolerances PT1000 AA

If the sensor cable is extended > 3 m, a “temperature correction value” can be set to compensate for the electrical resistance. (See the “Temperature sensor [▶ 100]” section).

### 13.3 PT1000 B (pipe surface contact sensor)

For the thermal disinfection function on the Wilo-Stratos MAXO-Z, the PT1000 B temperature sensor is available for measuring the temperature of the hot water tank. The temperature sensor must be connected to the pipe at the hot water outlet of the tank. The PT1000 B is connected at one of the two analogue inputs AI1 or AI2, which have to be set to the connection type PT1000.

Technical data of the PT1000 B:

- Tolerance class B in accordance with DIN EN 60751
- Cable length 5 m

Tolerances PT1000 B	
Temperature in °C	Accuracy in °C
10	+/- 0.35
20	+/-0.40
30	+/-0.45
40	+/-0.50
50	+/-0.55
60	+/-0.60
70	+/-0.65
80	+/-0.70
90	+/-0.75

Table 47: Tolerances PT1000 B

If the sensor cable is extended > 5 m, a “temperature correction value” can be set to compensate for the electrical resistance. (See the “Temperature sensor [▶ 100]” section).

### 13.4 Immersion sleeves

Immersion sleeves are available in two different lengths as an accessory for installing the immersion temperature sensor PT1000 AA in the pipe:

- immersion sleeve with length of engagement 45 mm for pipe diameter of DN 25 to approx. DN 50
- immersion sleeve with length of engagement 100 mm for pipe diameter of approx. DN 65 to DN 100

Technical data of the immersion sleeves:

- Pipe connection G ½ with width across flats AF 21
- PG 7 clamping ring screw connection with width across flats AF 13 to fix the temperature sensor in the immersion sleeve
- Outer diameter of the measuring pipe: 8 mm

### 13.5 CIF module

A retrofittable interface module (CIF module) is required to connect to building automation via a bus protocol.

The following CIF module types are available:

- BACnet IP
- BACnet MS/TP
- Modbus TCP
- Modbus RTU
- CANopen
- LON
- PLR

Data point lists for the respective bus protocols can be found at [www.wilo.de/automation](http://www.wilo.de/automation).

Depending on the inserted CIF module type, an associated settings menu is displayed in the menu. Select the following in the  “Settings” menu:

1. 1. “External interfaces”

The respective settings are described in the display and in the CIF module documentation.



## NOTICE

Explanations on commissioning as well as application, function and configuration of the CIF module on the pump are described in the installation and operating instructions for the CIF modules.

### 13.6 Angle plug

Angle plug for the electrical connection of the pump in confined installation conditions. The angle plug replaces the pump's mains plug. The angle plug is angled back towards the pump housing.

### 13.7 Fluid temperature sensor (Version R7)

Fluid temperature sensor/cable for the Stratos MAXO in the “R7” version. For retrofitting the internal temperature sensor to the Stratos MAXO -R7. Activates the range of functions of the Stratos MAXO (night setback, heating/cooling switchover (automatic), control functions T-const. and  $\Delta T$ -const. as well as heating/cooling quantity measurement with sensor source, internal temperature sensor, temperature display).

## 14 FAQs

### 14.1 Delivery state

#### **What happens to the date and time if the pump is stored at the distributor for several months?**

The Stratos MAXO has a battery to store this data. The service life of this battery is around 8 years.

### 14.2 CIF module/BMS

#### **What happens to the BMS (building management system) settings when reverting to factory settings?**

If a CIF module is connected, the selection options for the factory setting are adjusted. You can choose between: “factory settings (BMS retained)” and “complete factory settings”.

#### **Does the temperature sensor have to be connected to the pump or can the sensor also be integrated directly into the BMS?**

A temperature sensor, e.g. the return temperature sensor, can also be connected directly to the BMS. If the pump is also connected to the BMS via a CIF module, this signal is also transmitted to the pump.

This means that the heat quantity and the temperature of an on-site return sensor can be read both at the pump and via the BMS.

### 14.3 Display

#### **Is it possible to install a second graphic display on the MAXO-D and what does the display then show?**

On the Stratos MAXO-D, the LED display on the right-hand drive side can be easily replaced by a second graphic display. The graphic display is available as a spare part.

Settings can **only** be made on the graphic display on the left-hand pump drive. Entries on the graphic display of the pump partner are not possible. This can be identified by a lock symbol on the “Main menu symbol”. The symbol “SL” also appears on the display.

The displayed actual values on the display of the pump drive, which is not in operation, correspond 1:1 to the values of the active pump drive.

If a twin-head pump connection is established, entries on the graphic display of the pump partner are not possible. This can be identified by a lock symbol on the “Main menu symbol”.

#### **How can you tell that the right-hand drive side of the Stratos MAXO-D with the LED display is in “focus” when the connection has been established via Bluetooth using the Smart connect app?**



The outer LED bars light up.



- 14.4 Twin-head pump**
- Twin-head pump connection interrupted. What could have caused this?**  
The warning (H571) indicates that the twin-head pump connection has been interrupted. This is often the case if both pump heads have not been connected to the power supply.
- Can a twin-head pump also be operated like two single pumps and be controlled by an external switchgear or BMS?**  
Yes, it is possible.  
To do this, disconnect the twin-head pump connection (see the section “Two single pumps as a two-pump system in Y-piece joint [► 55]”) and replace the LED display on the right-hand pump drive with a graphic display.  
The graphic display is available as a spare part. All settings on the second pump drive can then be configured using the second graphic display.
- 14.5 Installation position**
- Can the pump heads of the twin-head pumps be rotated to reduce the installation dimensions?**  
Yes, the permitted installation positions are documented in the installation and operating instructions for the pump.
- 14.6 Battery**
- Can the battery in the Stratos MAXO be replaced?**  
The Stratos MAXO electronic module contains a lithium battery that cannot be replaced. For safety, health and data security reasons, do not remove the battery yourself!
- 14.7 Spare parts**
- What language is the replacement motor (RMOT) for the Stratos MAXO set in when delivered?**  
The factory setting for the replacement motor (RMOT) for Stratos MAXO /-D /-Z is English. The desired language can be adjusted as needed during initial commissioning. There are 26 possible languages.
- What spare parts are available for the Stratos MAXO pumps?**  
You can find the available spare parts for all Wilo-Stratos MAXO products in the Wilo spare parts catalogue: <https://spareparts.wilo.com>  
Original spare parts may only be obtained from local installers and/or Wilo customer service. To avoid queries and order errors, please provide all data on the rating plate with every order.
- 14.8 External interfaces**
- Where is the external differential pressure sensor (DDG) connected?**  
A DDG is connected either to the analogue input 1 (AI1) or to the analogue input 2 (AI2).
- How many external DDGs can be connected to the pump?**  
**Only** one DDG can be connected.
- What settings have to be configured on the pump to connect a DDG?**  
Settings → External interfaces → Function analogue input (AI1 or AI2) function → Set analogue input → Differential pressure sensor.
- How does the PID control work?**  
The PID controller (proportional-integral-derivative controller) consists of the components P term, the I term and the D term. In theory, this control function enables continuous monitoring and correction of the system parameters. In circuits where there are very rapid changes, the I term (response time) can be shortened to ensure that the setpoint is always adhered to.
- Are further accessories required for the Multi-Flow Adaptation function?**
- **Case A** – without mixer in the secondary loops  
No. The pumps are only wired to each other. No additional accessories are required besides the cables.
  - **Case B** – with mixer in the secondary loops  
Yes. Two temperature sensors are required for the feeder pump. 1x for the primary feed upstream of the heat exchanger or hydraulic shunt.  
1x downstream of the heat exchanger or hydraulic shunt.
- Furthermore, a temperature sensor is required for both the feed and return for the secondary pumps in the secondary loop. The internal temperature sensor may also be used depending on the installation position and the pump version. The heating or cooling quantity measurement must be activated on the pumps.

**After changing the pump from Stratos to Stratos MAXO, how does the connection of the 2-wire cable provided by the customer to the SSM connection of the Stratos MAXO work?**

The Stratos SSM connection is a potential-free normally closed contact, the Stratos MAXO SSM connection is a potential-free changeover contact. The 2-wire cable must be connected to terminals 75 and 76 of the Stratos MAXO.

**Can the analogue input (AI1 or AI2) also be used as output?**

The analogue inputs cannot be used as outputs.

**14.9 Error message**

**Is the error history stored in the pump or app?**

Yes, the error history is stored in the pump. The history can be accessed via the app under the "Messages" menu item.

The history cannot be read from the pump itself.

**Is the history of warning messages stored in the pump or app?**

Yes, for pumps with SW version "SW 01.05.10.00" some warning messages (e.g. W550 turbine operation, W551 undervoltage, W552 generator operation, W572 dry run detected) are stored in the history. The stored warning messages can be accessed via the app under the "Messages" menu item.

The history cannot be read from the pump itself.

**14.10 Heating & cooling**

**How does the automatic switchover from the heating to cooling mode work?**

Switchover takes place via an external binary contact. This is done via a data point from the building automation system or by detecting the feed temperature.

If the feed temperature is above 25 °C for example, the pump runs in heating mode with the corresponding set control mode.

If the feed temperature is below 19 °C for example, it runs with the corresponding setting.

The pump is idle between 19 °C and 25 °C and runs at short intervals to determine whether cooling or heating is required.

19 °C and 25 °C are the pre-set values, other settings are possible.

**14.11 Measured values**

**How accurately is the heat quantity determined?**

The heat quantity is determined with a level of accuracy of +/-10%. The calculation is based on the recorded volume flow and the recorded delta of the fluid temperature.

**How accurately is the cooling quantity determined?**

The cooling quantity is determined with a level of accuracy of +/-25%. The calculation is based on the recorded volume flow and the recorded delta of the fluid temperature.

**How accurately is the volume flow measured?**

The volume flow is measured with a level of accuracy of +/-5%. In the partial load range, the deviation is up to +/-3% of  $Q_{Max}$ . (valid for heating water without additives). The level of accuracy decreases when using a water-glycol mixture.

**Is the viscosity of the fluid taken into account when measuring the volume flow?**

No. The viscosity of water is always assumed. These parameters cannot be changed either.

**What sensors are integrated in the pump?**

The pump only has one integrated temperature sensor. It is a digital temperature sensor. The fluid temperature sensor communicates via CAN bus to the electronic module.

**Is the temperature sensor available as a spare part?**

Yes, the temperature sensor is available as a spare part.

**14.12 Control modes**

**Can Dynamic Adapt plus also be used for non-hydraulically balanced systems?**

Yes, Dynamic Adapt Plus also controls pumps to a reasonable degree in systems without hydronic balancing.

In extreme cases, a lack of balancing can lead to inadequate supply of hydraulically disadvantaged consumers. Dynamic Adapt plus cannot improve this situation. Subsequent, at least partial balancing is required here.

**14.13 Stratos MAXO plug**

**The electrical connection does not fit when replacing a Stratos MAXO pump in a confined installation environment. How can the problem be solved?**

An angle plug is available for the Stratos MAXO as a spare part.

The new angle plug enables simple wiring of the pump even in confined spaces. The angle

plug is designed to have a considerably reduced length compared to the conventional plug. To achieve this, the cable feed was offset by 90°.

- 14.14 Domestic hot water circulation** **Can the No-Flow Stop function be activated for the Stratos MAXO-Z?**
- If the application assistant is used, this function is unavailable.  
The No Flow function can be set via the basic control modes. However, this is not recommended.
- 14.15 Factory setting** **How does the heat and cooling quantity meter behave when factory settings are re-stored?**
- The heat and cooling quantity meter function has been deactivated in the Stratos MAXO factory settings. The setting must be re-configured. The heat and cooling quantity meter is reset to "0" with "Reset to factory settings".  
The overall heat quantity meter is not reset. See also sections "Factory settings" [► 49] and "Factory settings – defaults and parameters". [► 50]
- 14.16 Additional control functions** **At what time interval does the pump check whether a change in volume flow has occurred with No-Flow Stop?**
- The pump checks every 5 minutes (300 s) whether the volume flow requirement increases again. When the volume flow increases again, the pump continues running in its set control mode in normal operation. See also the "No-Flow Stop" [► 21] section.
- Is the additional function Q-Limit min/max possible in combination with a 0 to 10 V set-point control?**
- Only the setpoint for the control function is changed via 0 to 10 V control.  
Q-Limit min/max is an additional function which operates independently of this.  
Q-Limit min/max is not provided with all control modes, e.g. not with Q-const. With Q-const., the setpoint range can be specified via 0 to 10 V for the parameterisation of the transfer curve  $0\text{ V} = x\text{ m}^3/\text{h}$ ,  $10\text{ V} = y\text{ m}^3/\text{h}$ .
- Is the setting range for the additional function Q-Limit min possible below 10% of Qmax?**
- No, for technical reasons, the  $Q_{\min}$  lower limit cannot be under 10% of  $Q_{\max}$ .
- 14.17 Generator operation** **Does it damage the pump if it is operated in generator operation for a short period?**
- The "generator operation" is safe for the Stratos MAXO for a short period (approx. 15 to 30 minutes) if the permitted maximum speed of the respective pump is not exceeded. Exceeding the maximum speed results in increased wear, which reduces the service life.
- 14.18 Disabling Bluetooth** **Can the Bluetooth feature be permanently disabled ex works?**
- Deactivation of the Bluetooth interface at the factory is not planned.
- How can Bluetooth be disabled?**
- In the "Settings" menu → "Device settings" → select "Bluetooth On/Off".
- How can the disabled Bluetooth interface be protected against unauthorised access and adjustment from outside?**
- Via the "Settings" menu → "External interfaces" → "Function control input (DI1)" or "Function control input (DI2)" → activate "External key lock".  
Depending on the assignment of the digital control input DI1 or DI2, connect a jumper wire to terminals "33 and 31" or "43 and 41" in the terminal box.  
If the operating unit is fitted and secured, the key lock is active and cannot be deactivated from the outside.
- 14.19 Key lock** **How can the key lock on the pump be activated?**
- Back button  and Context button   
Activate/deactivate: Press both keys at the same time (< 5 s)
  - Setting via the menu  
Menu → Settings → Device settings → Key lock On
  - Binary input  
The pump can be switched with the "External key lock" function via external potential-free contacts (relay or switch) at the digital inputs DI1 (terminals 31 and 33) or DI2 (terminals 41 and 43).
    - Contact open: Key lock is deactivated.
    - Contact closed: Key lock is activated.

Menu → Settings → External interfaces → Function control input (DI1) or function control input (DI2) → External key lock



### NOTICE

Prevent unauthorised adjustment of the pump with the key lock via the binary input. Instead of a relay or switch, depending on assignment, a jumper wire can also be connected to terminals “33 and 31” or “43 and 41”.

## 14.20 Temperature sensor

### How many metres can the cable from the PT1000 temperature sensor be extended to?

The cable of the PT1000 immersion or contact sensor can be extended up to 300 m if required. This is safe from an electromagnetic compatibility point of view.

The resulting overall (cable) resistance from cable cross-section, cable length and connection (e.g. WAGO terminal) influences the temperature measurement of the PT1000.

The larger the selected cable cross-section, the lower the overall cable resistance for the outgoing and return lines.

The overall resistance of the cable can be compensated for by an adjustable temperature correction value.



### NOTICE

Set a temperature correction value to compensate for the electrical resistance if the cable length is more than 5 m.

If the PT1000 cable is extended with another cable, Wilo recommends the WAGO connection terminal type WAGO 221-2411.

### How is the temperature correction value determined for a cable extension?

**Option 1**, if exact temperature measurement is not required, carry out the following steps:

1. Measure the actual temperature on the PT1000.
2. Read off the actual temperature on the pump in the menu → Setting → “Analogue input (AI1 or AI2) → Overview of analogue input” (current value).
3. Determine the delta in Kelvin from both values (measure minus read off).
4. Enter this delta as correction value (offset) in the menu → “Set analogue input (AI1 or AI2) → Temperature correction”.



### NOTICE

If the delta is positive, set a negative temperature correction value, and if it is negative, set a positive one.

After entering the temperature correction value, check whether the newly displayed “current value” corresponds to the measured temperature value on the PT1000 sensor.

If yes, correction has been successful. If not, correct until the “current value” on the module corresponds to the measured value on the sensor.

**Option 2**, if an exact temperature measurement is required, carry out the following steps:

1. Immerse the PT1000 in 0 °C ice water and leave for approx. 1 minute.
2. Read off the actual temperature on the pump in the menu “Setting” → “Analogue input (AI1 or AI2)” → “Overview of analogue input” (current value).
3. As the temperature on the PT1000 is equal to 0 °C, the temperature reading (current value) must be entered as the temperature correction value in the following menu: Menu “Setting” → “Setting analogue input (AI1 or AI2)” → “Temperature correction”. The temperature correction value is entered in Kelvin.

The cable extension increases the resistance and results in a higher temperature (displayed as current value). As a result, the temperature correction value must be entered with a minus sign.

After entering the temperature correction value, check whether the newly displayed “current value” is 0 °C.

If yes, correction has been successful. If not, correct until the “current value” on the module is 0 °C.

For additional information, see the Actual value sensor configuration [► 72] section.

## 15 Pump settings with typical applications

### 15.1 Setting control mode “ $\Delta p$ -c” using the underfloor heating type of heating system as an application example

This section describes various pump settings step by step via the Stratos MAXO menu.

Starting situation

- Pump starts in factory settings DA+.

The following operating steps can be set via the menu using the control knob:

- **Settings** (turn control knob right + press)
  - **Set control mode** (press control knob)
    - **Setting assistant** (press control knob)
      - **Heating** (press control knob)
        - **Underfloor heating** (turn control knob right + press)
          - **Differential pressure  $\Delta p$ -c** (press control knob)

The setting returns to “Setting assistant”. To set a setpoint, press and hold the back button (left). The setting returns to the start screen.

- **Setpoint of the delivery head** (press control knob)
  - Turn to adjust the delivery head setpoint in increments of 0.1
  - Press to confirm the delivery head setpoint



#### NOTICE

The set system type and the set control mode are shown at the top of the display.

The actual duty point and the measured values are shown on the right-hand side of the display.

### 15.2 Setting “Volume flow Q-c” in the basic control modes

Starting situation

- Pump starts in factory settings DA+.

The following operating steps can be set via the menu using the control knob:

- **Settings** (turn control knob right + press)
  - **Set control mode** (press control knob)
    - **Setting assistant** (press control knob)
      - **Basic control modes** (press control knob)
        - **Volume flow Q-c** (turn control knob right + press)

The setting returns to “Setting assistant”. To set a setpoint, press and hold the back button (left). The setting returns to the start screen.

- **Setpoint volume flow** (press control knob)
  - Turn to adjust the volume flow setpoint in increments of 0.1
  - Press the control knob to confirm the volume flow setpoint



#### NOTICE

The set control mode is shown at the top of the display.

The actual duty point and the measured values are shown on the right-hand side of the display.

### 15.3 Setting “External interfaces 0-10V”

Starting situation

- Pump starts in factory settings DA+.
- An external sensor is already connected to analogue input AI1 or analogue input AI2.

The following operating steps can be set via the menu using the control knob:

- **Settings** (turn control knob right + press)
- **Set control mode** (press control knob)
- **Setting assistant** (press control knob)
- **e.g. heating** (press control knob)
- **Underfloor heating** (turn control knob right + press)
- **Differential pressure  $\Delta p-c$**  (press control knob)

The setting returns to "Setting assistant". Resume navigation.

- **Setpoint delivery head** (Press Context button  + turn left + press)
- **External setpoint** (turn control knob)

Depending on assignment, select either **analogue input AI1** or **analogue input AI2** (turn control knob right + press).

- **External setpoint source** (turn control knob right + press)
- **Set setpoint source** (turn control knob right + press)
- **Setpoint sensor** (turn control knob right + press)
- **0-10 V** (press control knob)
- **e.g. use specification** (press control knob)

→ Press and hold **back button** (left); the setting returns to the start screen.

The blue LED below the display lights up. The setpoint delivery head field in the display is marked with a blue frame, as is the display of the active analogue input (either analogue input AI1 or analogue input AI2).

#### 15.4 Setting "control mode T-c" including configuration of a PT1000 temperature sensor

Starting situation

- Pump starts in factory settings DA+.
- A PT1000 is, for example, connected to analogue input AI1.

The following operating steps can be set via the menu using the control knob:

- **Settings** (turn control knob right + press)
- **Set control mode** (press control knob)
- **Setting assistant** (press control knob)
- **e.g. heating** (press control knob)
- **Fan heater** (turn control knob right + press)
- **Hall temperature T-c** (turn control knob right + press)
- **Sensor source T1 – analogue input 1** (turn control knob right + press)
- **Setpoint temperature T-c** (turn control knob right + press)
- **Set setpoint temperature** up to e.g. 25 °C (turn control knob right + press)
- **Temperature sensor T1** (turn control knob right + press)
- **Set sensor input** up to e.g. 25 °C (turn control knob right + press)
- **Temperature sensor** (turn control knob right + press)
- **PT1000** (press control knob)

→ Press and hold **back button** (left); the setting returns to the start screen.

#### 15.5 Setting "control mode $\Delta T-c$ " in the heating application – including

Starting situation

- Pump starts in factory settings DA+.

### configuration of a PT1000 temperature sensor

- A PT1000 is, for example, connected to analogue input AI1.

The following operating steps can be set via the menu using the control knob:

- **Settings** (turn control knob right + press)
  - **Set control mode** (press control knob)
    - **Setting assistant** (press control knob)
      - **Heating** (press control knob)
        - **Basic control modes** (turn control knob right + press)
          - **Temperature difference  $\Delta T-c$**  (turn control knob right + press)
            - **Sensor source T1**, analogue input 1 (turn control knob right + press)
            - **Sensor source T2**, internal sensor (press control knob)
  - **Temperature sensor T1** (turn control knob right + press)
    - **Set sensor input** (turn control knob right + press)
      - **Temperature sensor** (turn control knob right + press)
    - **PT1000** (press control knob)
  - **Setpoint temperature  $\Delta T-c$**  (turn control knob right + press)
    - **Set setpoint temperature** up to e.g. -20.0 K (turn control knob left + press)



#### NOTICE

A negative temperature value is required for the “heating” application.

→ Press and hold **back button** (left); the setting returns to the start screen.

### 15.6 Setting “control mode $\Delta T-c$ ” in the cooling application – including configuration of a PT1000 temperature sensor

Starting situation

- Pump starts in factory settings DA+.
- A PT1000 is, for example, connected to analogue input AI1.

The following operating steps can be set via the menu using the control knob:

- **Settings** (turn control knob right + press)
  - **Set control mode** (press control knob)
    - **Setting assistant** (press control knob)
      - **Cooling** (press control knob)
        - **Basic control modes** (turn control knob right + press)
          - **Temperature difference  $\Delta T-c$**  (turn control knob right + press)
            - **Sensor source T1**, analogue input 1 (turn control knob right + press)
            - **Sensor source T2**, internal sensor (press control knob)
  - **Temperature sensor T1** (turn control knob right + press)
    - **Set sensor input** (turn control knob right + press)
      - **Temperature sensor** (turn control knob right + press)
    - **PT1000** (press control knob)
  - **Setpoint temperature  $\Delta T-c$**  (turn control knob right + press)
    - **Set setpoint temperature** up to e.g. 20.0 K (turn control knob left + press)



## NOTICE

A positive temperature value is required for the “cooling” application.

→ Press and hold **back button** (left); the setting returns to the start screen.

### 15.7 Setting “Temperature correction”

The following operating steps can be set via the menu using the control knob:

- **Settings** (turn control knob right + press)
  - **Set control mode** (press control knob)
    - **Setting assistant** (press control knob)
      - **Basic control modes** (press control knob)
        - **Temperature T-c** (turn control knob right + press)
          - **Sensor source T1 – analogue input 1** (turn control knob right + press)
            - **Temperature sensor T1** (press control knob)
              - **Temperature correction** (turn control knob right + press)

### 15.8 Setting “Heat quantity measurement”

Starting situation

- Pump starts in factory setting DA+.
- A PT1000 is, for example, connected to analogue input AI1.

The following operating steps can be set via the menu using the control knob:

- **Diagnostics and measured values** (turn control knob right + press)
  - **Heat/cooling quantity measurement** (turn control knob right + press)
    - **Heat/cooling quantity On/Off** (Press control knob)
      - **Switched on** (turn control knob right + press)
    - **Sensor feed temperature** (turn control knob right + press)
      - **Select sensor source** (press control knob)
        - **Internal sensor** (press control knob)
      - **Select sensor position** (turn control knob right + press)
        - **Feed** (turn control knob right + press)
    - Press **back button** (left)
    - **Sensor return temperature** (turn control knob right + press)
      - **Select sensor source** (press control knob)
        - **Analogue input 1** (turn control knob right + press)
      - **Set sensor input** (turn control knob right + press)
        - **Temperature sensor** (turn control knob right + press)
          - **PT1000** (press control knob)
        - **Select sensor position** (turn control knob right + press)
          - **Return** (turn control knob right + press)
        - **Back button** (turn control knob right + press)
      - **Display of heat quantity** (turn control knob right + press)



- **Set heat quantity to “0”** (context button  + turn control knob left + press)

### 15.9 Setting automatic “switching between heating and cooling”

Starting situation

- Pump starts in factory setting DA+.

The following operating steps can be set via the menu using the control knob:

- **Settings** (turn control knob right + press)
  - **Set control mode** (press control knob)
    - **Setting assistant** (press control knob)
      - **Heating & cooling** (turn control knob right + press)
        - **Continue with settings for cooling** (press control knob)
  - **Underfloor cooling** (turn control knob right + press)
    - **Differential pressure  $\Delta p$ -c** (press control knob)

To set the respective setpoint of the delivery head, proceed as follows:

- **Setpoint delivery head  $\Delta p$ -v** (turn control knob right + press)  
Set the differential pressure  $\Delta p$ -v setpoint and confirm by pressing the key.
- **Heating/cooling switchover** (turn control knob left + press)
  - **Cooling** (turn control knob right + press)
    - **Setpoint delivery head  $\Delta p$ -c** (turn control knob right + press)  
Set the differential pressure  $\Delta p$ -c setpoint and confirm by pressing the key.

To set the automatic switchover between heating and cooling, proceed as follows:

- **Heating/cooling switchover** (turn control knob left + press)
  - **Automatic** (turn control knob right + press)  
Set the “Heating” switchover temperature and “Cooling” switchover temperature and confirm each by pressing the control knob.

→ Press and hold **back button** (left); the setting returns to the start screen.



#### NOTICE

The display shows which application (heating or cooling symbol) is currently active in “Heating and cooling” in the active influences area.

### 15.10 Setting two single pumps in dual-pump operation

Starting situation

- Pumps start in factory setting DA+.
- Both pumps are connected with a cable via the Wilo Net interface.

The following settings must be configured **on both pumps**:

- **Settings** (turn control knob right + press)
  - **External interfaces** (turn control knob right + press)
    - **Wilo Net setting** (turn control knob right + press)
      - **Wilo Net termination** (turn control knob left + press)
        - **Switched on** (press control knob)
      - **Wilo Net address** (turn control knob right + press)
        - **Assign address 1 or 2** (press control knob)

→ Press and hold **back button** (left); the setting returns to the start screen.

Configure the settings **on the second pump** in the same way:

Set dual-pump operation:

The settings are only configured on the main pump:

- **Settings** (turn control knob right + press)
- **Dual-pump operation** (turn control knob right + press)
  - **Type of twin-head pump housing** (turn control knob right + press)
    - **Single pump** (turn control knob left + press)
      - **Connect twin-head pump** (press control knob)
        - **Select partner** (turn control knob right + press)

The partner is in “focus” and the blue LED display flashes.

- **Confirmation on the main pump** (press control knob)
- **Adopt configuration from this pump** (press control knob)
  - **Twin-head pump connection requires a restart** (press control knob)



#### NOTICE

Following the re-start, the blue LED displays on both pumps flash.

---



#### NOTICE

Settings on the twin-head pump can only be adjusted on pump 1 (main pump).

---



#### NOTICE

The display shows which dual-pump operation – peak-load operation (▲+△) or main/standby operation (▲ | △) is active in the active influences area.

---



#### NOTICE

An “SL” symbol and the symbol for key lock also appear on the display of pump 2.

---

### 15.11 Setting “Detection of thermal disinfection”

Starting situation

- Pump starts in factory settings DA+.
- PT1000 B is connected to the analogue input AI1.

The following operating steps can be set via the menu using the control knob:

- **Settings** (turn control knob right + press)
  - **Set control mode** (press control knob)
    - **Detection of disinfection** (turn control knob right + press)
      - **Switched on** (turn control knob right + press)
      - Set **disinfection limit value** (press control knob)
      - **Sensor detection of disinfection** (turn control knob right + press)



## NOTICE

The factory setting for the temperature sensor of thermal disinfection is the analogue input AI1.  
If necessary, this can be changed.

---

- **Set sensor input** (turn control knob right + press)
  - Select **Temperature sensor** for type of use at analogue input AI1 (turn control knob right + press)
  - Select **PT1000** for signal type and analogue input AI1 for temperature sensor. (Press control knob)
- Press and hold **back button** (left); the setting returns to the start screen.
- 



## NOTICE

The temperature measurements for the control mode T-c and for the disinfection detection cannot be taken with the same temperature sensor. In this case, the control mode switches to n-const. with the set emergency operation speed.

---









# wilo



Local contact at  
[www.wilo.com/contact](http://www.wilo.com/contact)

Pioneering for You

WILO SE  
Wilopark 1  
44263 Dortmund  
Germany  
T +49 (0)231 4102-0  
T +49 (0)231 4102-7363  
[wilo@wilo.com](mailto:wilo@wilo.com)  
[www.wilo.com](http://www.wilo.com)