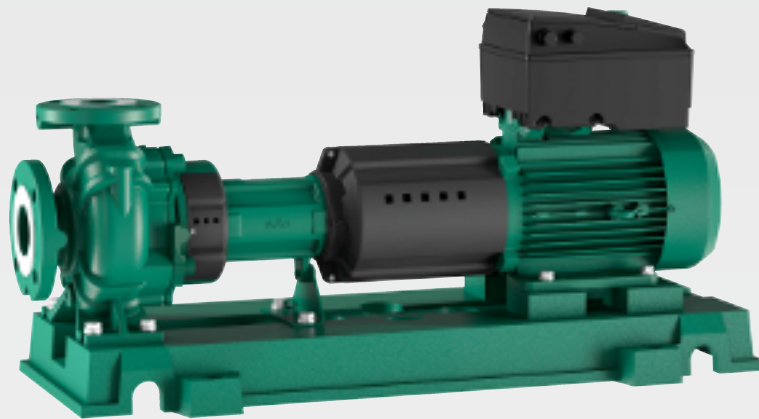


Wilo-Yonos GIGA-N



en Installation and operating instructions



Table of contents

1	General information	5
1.1	About these instructions	5
1.2	Copyright	5
1.3	Subject to change	5
2	Safety	5
2.1	Identification of safety instructions	5
2.2	Personnel qualifications	6
2.3	Electrical work	6
2.4	Transport	7
2.5	Installing/dismantling	7
2.6	During operation	7
2.7	Maintenance tasks	8
2.8	Operator responsibilities	8
3	Application/use	9
3.1	Intended use	9
3.2	Improper use	9
4	Product description	9
4.1	Design	9
4.2	Electronic module	9
4.3	Twin-head pump function/Y-pipe application	11
4.4	Other functions	15
4.5	Variants	16
4.6	Type key	16
4.7	Technical data	17
4.8	Scope of delivery	18
4.9	Accessories	18
4.10	Permissible forces and torques on the pump flanges	18
5	Transportation and storage	19
5.1	Delivery	19
5.2	Transport	19
5.3	Storage	20
6	Installation and electrical connection	21
6.1	Personnel qualifications	21
6.2	Operator responsibilities	21
6.3	Preparing the installation	21
6.4	Installing the pump unit on a base	21
6.5	Pipework	23
6.6	Aligning the unit	24
6.7	Electrical connection	28
6.8	Protective devices	34
7	Commissioning	35
7.1	Personnel qualifications	35
7.2	Filling and venting	35
7.3	Twin-head pump installation/Y-pipe installation	36
7.4	Setting of pump output	36
7.5	Switching on the pump	37
7.6	Behaviour after being switched on	38
7.7	Setting the control mode	38
8	Operation	39
8.1	Operating elements	39
8.2	Display structure	39
8.3	Explanation of standard symbols	40
8.4	Symbols in graphics/instructions	40

8.5	Display modes	41
8.6	Operating instructions	43
8.7	Menu elements reference	47
9	Shutdown.....	53
9.1	Switching off the pump and temporary shutdown.....	53
9.2	Shutdown and storage	53
10	Maintenance/repair	53
10.1	Personnel qualifications.....	54
10.2	Operation monitoring.....	54
10.3	Maintenance tasks.....	55
10.4	Draining and cleaning.....	55
10.5	Dismantling.....	55
10.6	Installation	59
11	Spare parts.....	63
11.1	Spare parts list	64
12	Faults, causes and remedies	65
12.1	Mechanical faults	66
12.2	Error codes, display	67
12.3	Acknowledge fault.....	71
13	Factory settings	76
14	Disposal.....	77
14.1	Oils and lubricants.....	77
14.2	Water-glycol mixture	77
14.3	Protective clothing	77
14.4	Information on the collection of used electrical and electronic products.....	77

1 General information

1.1 About these instructions

These installation and operating instructions are an integral part of the device. Read these instructions before commencing work and keep them in an accessible place at all times. Strict adherence to these instructions is a requirement for intended use and correctly operating the device. All specifications and markings on the device must be observed. These installation and operating instructions correspond to the relevant version of the device and the underlying safety standards that apply at the time of going to print.

The language of the original operating instructions is German. All other languages of these instructions are translations of the original operating instructions.

1.2 Copyright

These installation and operating instructions have been copyrighted by the manufacturer. The contents, of whatever type, may not be reproduced or distributed, or used for purposes of competition and shared with others.

1.3 Subject to change

The manufacturer reserves the right to make technical modifications to the device or individual components. The illustrations used may differ from the original and are intended as an example representation of the device.

2 Safety

This chapter contains basic information for the individual phases of the life cycle. Failure to observe this information carries the following risks:

- Injury to persons from electrical, mechanical and bacteriological factors as well as electromagnetic fields
- Environmental damage from discharge of hazardous substances
- Property damage
- Failure of important functions of the product

Failure to observe the information contained herein will result in the loss of claims for damages.

The instructions and safety instructions in the other chapters must also be observed!

2.1 Identification of safety instructions

These installation and operating instructions set out safety instructions for preventing personal injury and damage to property. These safety instructions are shown differently:

- Safety instructions relating to personal injury start with a signal word, are **preceded by a corresponding symbol** and are shaded in grey.



DANGER

Type and source of the danger!

Consequences of the danger and instructions for avoidance.

- Safety instructions relating to property damage start with a signal word and are displayed **without** a symbol.

CAUTION

Type and source of the danger!

Consequences or information.

Signal words

- **DANGER!**
Failure to observe the safety instructions will result in serious injuries or death!
- **WARNING!**
Failure to follow the instructions can lead to (serious) injuries!
- **CAUTION!**
Failure to follow the instructions can lead to property damage and a possible total loss.
- **NOTICE!**
Useful information on handling the product

Symbols

These instructions use the following symbols:



Danger – high voltage



General warning symbol



Warning – danger of crushing



Warning – risk of cutting injuries



Warning – hot surfaces



Warning – high pressure



Warning – suspended loads



Personal protective equipment: wear a safety helmet



Personal protective equipment: wear foot protection



Personal protective equipment: wear hand protection



Personal protective equipment: wear mouth protection



Personal protective equipment: wear safety goggles



Useful information

2.2 Personnel qualifications

Personnel must:

- Be instructed about locally applicable regulations governing accident prevention.
- Have read and understood the installation and operating instructions.

Personnel must have the following qualifications:

- Electrical work: A qualified electrician must carry out the electrical work.
- Installation/dismantling must be carried out by a qualified technician who is trained in the use of the necessary tools and fixation materials.

Definition of “qualified electrician”

A qualified electrician is a person with appropriate technical education, knowledge and experience who can identify **and** prevent electrical hazards.

2.3 Electrical work

- Have electrical work carried out by a qualified electrician.
- When connecting to the mains, comply with the locally applicable laws and regulations of the local energy supply company.

- Before commencing work, disconnect the product from the mains and secure it against being switched on again without authorisation.
 - Give personnel training on how to establish the electrical connection and the methods for switching off the product.
 - Observe the technical information in these installation and operating instructions as well as on the rating plate.
 - Earth the product.
 - Observe the manufacturer's specifications when connecting to electrical switching systems.
 - Replace defective connection cables. Contact customer service.
- 2.4 Transport**
- Wear protective equipment:
 - Safety gloves for protection against cuts
 - Safety shoes
 - Sealed safety goggles
 - Safety helmet (when using lifting equipment)
 - Only use legally specified and approved lifting gear.
 - Select lifting gear based on the available conditions (weather, attachment point, load, etc.).
 - Always attach the lifting gear to the designated attachment points (lifting eyes).
 - Position the lifting equipment in a way that ensures stability during use.
 - When using lifting equipment, a second person must be present to coordinate the procedure if required (e.g. if the operator's field of vision is blocked).
 - Persons must not stand underneath suspended loads. Do **not** move suspended loads over workplaces where people are present.
- Please note the following information during transport and prior to installation:**
- Do not reach into suction ports, discharge ports or other openings.
 - Avoid the penetration of foreign objects. To this end, leave the protective covers or packaging on until they have to be removed for installation.
 - Packaging and covers may be removed from suction or outlet openings for inspection purposes. They must be put back on afterwards to protect the pump and ensure safety.
- 2.5 Installing/dismantling**
- Wear the following protective equipment:
 - Safety shoes
 - Safety gloves for protection against cuts
 - Safety helmet (when using lifting equipment)
 - Comply with laws and regulations on work safety and accident prevention in force at the site of installation.
 - The procedure described in the installation and operating instructions for shutting down the product/unit must be strictly observed.
 - Disconnect the device from the mains and secure it against being switched on again without authorisation.
 - All rotating parts must be at a standstill.
 - Close the gate valve in the inlet and in the pressure pipe.
 - Provide adequate aeration in enclosed spaces.
 - Clean the device thoroughly. Disinfect devices that use fluids hazardous to health!
 - Make sure that there is no risk of explosion when carrying out any type of welding work or work with electrical devices.
- 2.6 During operation**
- Wear protective equipment:
 - Safety shoes
 - Safety helmet (when using lifting equipment)
 - The work area in which the device is used is not a recreational area. No persons are allowed in the work area during operation.
 - The operator must report any faults or irregularities to a line manager immediately.
 - If hazardous defects occur, the operator must immediately deactivate the device. Hazardous defects include:
 - Malfunction of safety and monitoring devices
 - Damage to housing parts
 - Damage to electrical equipment
 - Open all gate valves in the piping on both the suction and pressure sides.
 - Collect any leakage of fluids and operating fluids immediately and dispose of it according to the locally applicable guidelines.
 - Tools and other objects should only be kept in their designated places.

Thermal hazards

Most of the pump and drive surfaces can become hot during operation.

The surfaces in question also remain hot after switching off the unit. These surfaces may only be touched with extreme caution. Wear protective gloves if it is essential to touch hot surfaces.

Make sure that the drained water is not too hot for more intensive contact with skin.

Install appropriate equipment to safeguard against contact with components that may become hot.

Hazard due to articles of clothing or other objects being caught

To avoid the dangers presented by the rotating parts of the device:

- Do not wear loose or frayed clothing or jewellery.
- Do not dismantle devices for protecting against accidental contact with moving parts (e.g. coupling guard).
- Only put the device into operation once this protection is in place.
- The devices for protecting against accidental contact with moving parts may only be removed when the system is at a standstill.

Hazards due to noise

Observe the applicable health and safety regulations. If the device is operated under normal operating conditions, the operator must measure the sound pressure.

Sound pressure levels of 80 dB(A) and above must be noted in the work regulations! The operator must also introduce the following preventative measures:

- Inform the operating personnel
- Provide hearing protection

For a sound pressure level of 85 dB(A) and above, the operator must:

- Make it a mandatory requirement to wear hearing protection
- Demarcate the noisy areas
- Take measures to reduce noise (e.g. insulation, noise barriers)

Leakages

Observe local standards and regulations. Avoid pump leakages to protect persons and the environment against hazardous (explosive, toxic or hot) substances.

Ensure that a dry run of the pump is not possible. A dry run can damage the shaft seal and thereby cause leakages.

2.7 Maintenance tasks

- Wear the following protective equipment:
 - Sealed safety goggles
 - Safety shoes
 - Safety gloves for protection against cuts
- Only carry out the maintenance tasks described in these installation and operating instructions.
- Only original parts from the manufacturer may be used for maintenance and repairs. Use of parts other than original parts releases the manufacturer from any liability.
- Collect any leakage of fluid and operating fluid immediately and dispose of it according to the locally applicable guidelines.
- Store tools at the designated locations.
- After completing work, reattach all safety and monitoring devices and check that they function properly.

2.8 Operator responsibilities

The operator must:

- Provide the installation and operating instructions in a language which the personnel can understand.
- Make sure that personnel are suitably trained for the specified work.
- Ensure that safety and information signs mounted on the device are always legible.
- Train personnel with regard to the operating principles of the system.
- Eliminate any risk from electrical current.
- Equip hazardous components (extremely cold, extremely hot, rotating, etc.) with an on-site guard.
- Demarcate and cordon off the hazardous area.
- Define personnel responsibilities to ensure safe working practice.

Children and persons younger than 16 years or with reduced physical, sensory or mental capacities or limited experience are prohibited from handling the device! Persons under the age of 18 must be supervised by a technician.

3 Application/use

3.1 Intended use

The glanded pumps in the Wilo-Yonos GIGA-N series are intended for use as circulators in building services.

The Wilo-Yonos GIGA-N pumps may be used for:

- Hot-water heating systems
- Cooling and cold water circulation systems
- Industrial circulation systems
- Heat carrier circuits
- Irrigation

The pumps are only approved for the fluids specified in the “Technical data” section.

Installation within a building

Typical installation locations are technical rooms within the building with other domestic installations. No provision has been made for direct installation of the pump in rooms used for other purposes (residential and work rooms). The installation location must be dry, well ventilated and frost-resistant.

Installation outside a building (outdoor installation)

- Install the pump in a housing as weather protection. Observe ambient temperatures. Permissible ambient temperature for outdoor installation, see “Technical data” table.
- Protect the pump against the effects of weather such as direct sunlight, rain and snow.
- Take suitable measures to prevent the formation of condensation water

Intended use also includes compliance with this manual. Any other use is regarded as non-compliant with intended use.

3.2 Improper use

WARNING! Misuse of the pump can lead to dangerous situations and damage.

- Never use with fluids that have not been approved by the manufacturer.
- Non-permitted substances in the fluid can destroy the pump. Abrasive solids (e.g. sand) increase pump wear.
- Highly flammable materials/fluids should always be kept at a safe distance from the device.
- Never allow unauthorised persons to carry out work.
- Never operate the pump beyond the specified limits of use.
- Never carry out unauthorised conversions.
- Use authorised accessories and genuine spare parts only.

4 Product description

4.1 Design

The Wilo-Yonos GIGA-N pump is a single-stage back pull-out centrifugal pump with spiral housing for horizontal installation. Power and dimensions conform to EN 733.

The drive has an integrated electronic speed control. This allows optimisation of the pump output for the demands of the installation and particularly cost-efficient pump operation.

4.1.1 Hydraulics

The pump consists of a radially divided spiral housing (optionally with replaceable neck rings) and cast-on pump support feet. The impeller is a closed radial impeller. The pump shaft is supported by grease-lubricated radial ball bearings.

4.1.2 Drive

AC motors with integrated frequency converters are used as drives.

4.1.3 Seal

The fluid pump is sealed via a mechanical seal in accordance with EN 12756.

4.2 Electronic module

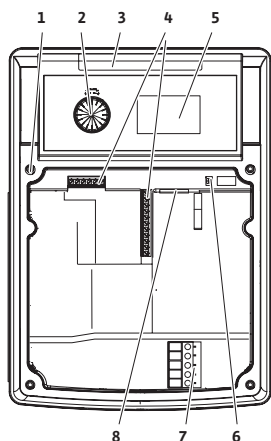
Depending on the differential pressure and the control mode setting, the electronic module controls the speed of the pump according to a setpoint which can be adjusted within the permissible control range.

The continuous adjustment of the hydraulic output follows the changing power demand of the system. Changing requirements arise particularly when thermostatic valves or mixers are used.

The basic advantages of the electronic control system are:

- Energy savings and reduced operating costs at the same time
- Reduced number of differential pressure valves required
- Reduction of flow noise
- Pump can be adapted to changing operating requirements

1.5 ... 7.5 kW:



1	Cover attachment points
2	Operating button
3	Infrared window
4	Control terminals
5	Display
6	DIP switch
7	Power terminals (mains terminals)
8	Interface for IF module

11 ... 22 kW:

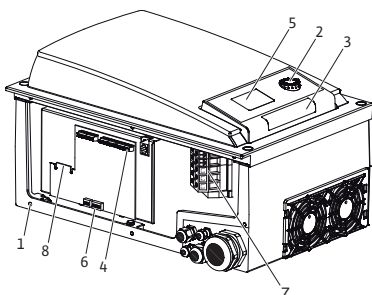


Fig. 1: Electronic module, overview

4.2.1 Control modes



NOTICE

For details of setting the control mode and associated parameters, see the “Operation” and “Control mode” chapters.

Selectable control modes are:

Constant differential pressure ($\Delta p-c$)

The control system keeps the delivery head constant at the adjusted differential pressure setpoint H_s . Control is independent of the volume flow and is applied until the maximum characteristic curve is reached.

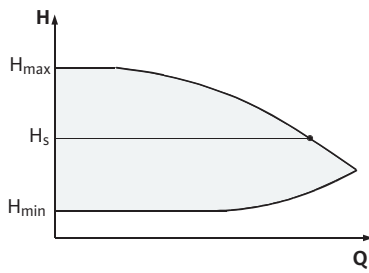
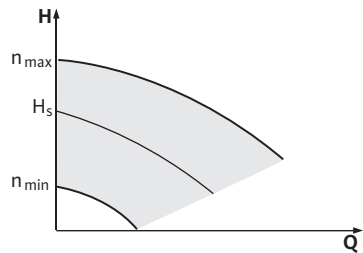
Fig. 2: Control mode Δp -c

Fig. 3: Constant speed

Q = Volume flow

H = Differential pressure (min./max.)

H_s = Differential pressure setpoint

Constant rotation speed (constant speed)

The speed of the pump can be kept to a constant speed between n_{\min} and n_{\max} . "Constant speed" mode deactivates all other control modes.

PID control

If other sensors are used or if the distance between the sensors and the pump is very large, the standard control modes are not applicable. In these cases, the "PID-Control" function (Proportional Integral Differential control) is available.

By selecting a good combination of individual control elements, the operator can ensure fast-reacting, constant control without lasting setpoint deviations. The output signal of the selected sensor can accept any intermediate value. The relevant actual value reached (sensor signal) will be shown as a percentage on the status page of the menu (100 % = maximum measurement range of the sensor).



NOTICE

The displayed percent value only corresponds indirectly to the current delivery head of the pump(s).

The maximum delivery head can even be reached at a sensor signal of < 100 %.

4.3 Twin-head pump function/Y-pipe application



NOTICE

The properties described in this section are only available if the internal MP interface (MP = Multi Pump) is used.

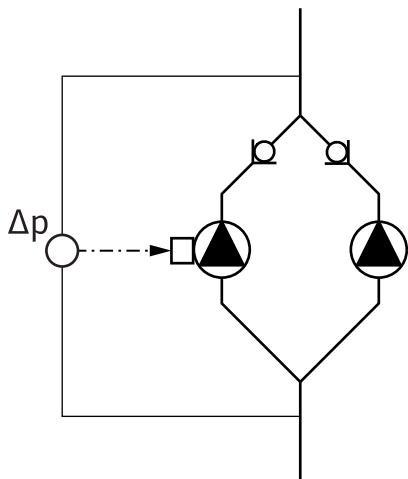


Fig. 4: Example – differential pressure sensor connection in y-pipe installation

Both pumps are controlled by the master pump.

If one of the pumps malfunctions, the other will run according to the master’s control settings. In case of a total failure of the master, the slave pump operates at emergency operation speed. The emergency operation speed can be set in menu <5.6.2.0> (see section “Operation during interruption of communication”).

The master display shows the status of the double pump. On the slave, the display shows ‘SL’.

In the example, the master pump is the left-hand pump in the direction of flow. Connect the differential pressure sensor to this pump!

The measuring points of the differential pressure sensor must be on the suction and discharge side of the double-pump system in the common collector pipe.

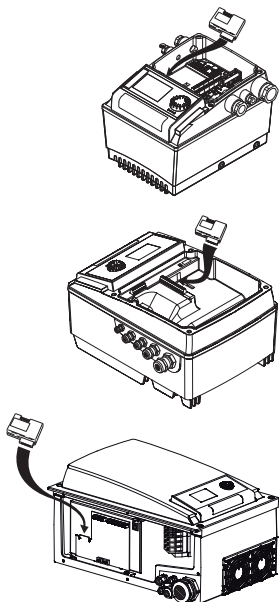


Fig. 5: Insert IF module

Interface module (IF module)

For communication between pumps and the building management system, one IF module (accessories) is required, which is plugged into the terminal room.

The master-slave communication uses an internal interface (terminal: MP).

For pumps in Y-pipe applications in which the electronic modules are connected to each other via the internal interface, only the master pumps require an IF module.

Communication	Master pump	Slave pump
PLR/interface converter	IF module PLR	No IF module necessary
LONWORKS network	IF module LON	No IF module necessary
BACnet	BACnet IF module	No IF module necessary
Modbus	Modbus IF module	No IF module necessary
CAN bus	IF module CAN	No IF module necessary

Table 1: IF modules



NOTICE

The procedure and further information for commissioning and configuring the IF module on the pump can be found in the installation and operating instructions of the IF module used.

4.3.1 Operating modes

Main/standby operation

Only one pump ever runs at a time. Each of the two pumps provides the configured flow rate. The other pump is available in case of malfunction or runs after pump cycling.

4.3.2 Behaviour in twin-head pump operation

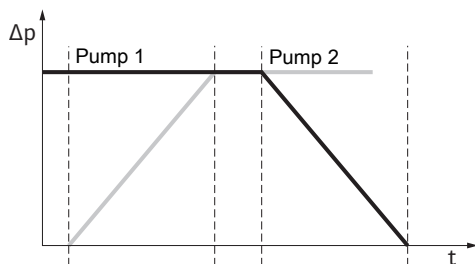


Fig. 6: Pump cycling, schematic representation

Pump cycling

With twin-head pump operation, pump cycling occurs periodically (the intervals can be set; factory setting = 24 hours).

Pump cycling can be triggered:

- Internally, time-controlled (menu <5.1.3.2> + <5.1.3.3>)
- Externally (menu <5.1.3.2>) by a positive beam on the “AUX” contact
- Manual (menu <5.1.3.1>)

Manual or external pump cycling is possible 5 seconds after the last pump cycling at the earliest.

Activating external pump cycling simultaneously deactivates internal time-controlled pump cycling.

Schematised description of pump cycling operation (see diagram):

- Pump 1 is running (black line)
- Pump 2 is switched on at minimum speed and soon afterwards reaches the setpoint (grey line)
- Pump 1 is switched off
- Pump 2 continues to run until the next pump cycling



NOTICE

In constant speed mode, a slight increase in flow can be expected. Pump cycling is dependent on the ramp time and generally lasts 2 sec. In control mode, there may be minor fluctuations in the delivery head. However, pump 1 adjusts itself to the changed conditions. Pump cycling is dependent on the ramp time and generally lasts 4 sec.

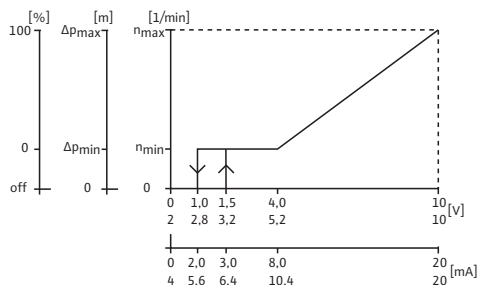


Fig. 7: Behaviour of the inputs and outputs

Behaviour of the inputs and outputs

Actual value input In1, setpoint input In2.

- At the master: acts on the whole unit

“External off”

- Set at the master (menu <5.1.7.0>): Depending on the setting in menu <5.1.7.0>, acts only on the master or on the master and the slave
- Set at the slave: Acts only on the slave

Fault and run signals

Single (ESM) or collective fault signal (SBM):

A collective fault signal (SSM) can be connected to the master to create a central control centre. In this case, contact may only be made to the master. The display is for the whole unit.

The contact must be made to each pump for individual fault signals.

This signal can be programmed on the master (or using the IR-Monitor/IR-Stick) as an individual fault signal (ESM) or collective fault signal (SSM) in menu <5.1.5.0>.

The functions of EBMs/SBMs – “Readiness”, “Operation”, “Mains on” – can be set in menu <5.7.6.0> on the master.



NOTICE

- “Readiness” means: The pump is able to run, there is no fault.
- “Operation” means: Motor running.
- “Mains on” means: Mains voltage is available.

**NOTICE**

If the “Operation” function has been selected for EBMs/SBMs, each pump kick executed causes a message to appear for a few seconds.

Operating possibilities at the slave pump

The only settings that are possible at the slave are “External off” and “Disable/enable pump”.

**NOTICE**

If an individual motor is disconnected from the power supply in dual-pump operation, the integrated dual-pump management is out of operation.

4.3.3 Operation during interruption of communication

When communication is interrupted between two pumps in twin-head pump operation, both displays show the error code “E052”. Both pumps behave as single pumps for as long as the interruption lasts.

Both electronic modules report the malfunction via the ESM/SSM contact.


The slave pump runs in emergency operation (constant speed) mode according to the emergency operation speed previously set on the master (see menu items <5.6.2.0>).

The factory setting for the emergency operation speed is about 60% of the pump’s maximum speed.

→ For 2-pole pumps: $n = 1850$ rpm

→ For 4-pole pumps: $n = 925$ rpm

After acknowledging the fault display, the status display will be shown on both pump displays for as long as communication is interrupted. This resets the ESM/SSM contact at the same time.

The slave pump display flashes and shows the symbol  – Pump running in emergency operation).

The (former) master pump still follows the control instructions. The (former) slave pump follows the emergency operation settings. Emergency operation can only be exited by triggering the factory setting, resolving the interruption in communication or by switching “mains off/on”.

**NOTICE****The differential pressure sensor is switched to the master!**

During communication interruptions, the (former) slave pump cannot run in control mode. When the slave pump is running in emergency operation mode, changes cannot be made to the electronic module.

After the communication interruption has been resolved, the pumps will resume regular twin-head pump operation, as before the malfunction.

Slave pump behaviour

Exiting emergency operation at the slave pump:

→ Factory settings restored

During a communication interruption on the (former) slave, if emergency operation is discontinued because the factory settings have been restored, the (former) slave will start up with the factory settings of a single pump. It will then run in Δp -c operating mode at about half the maximum delivery head.

**NOTICE****In the absence of a sensor signal, the (former) slave will run at maximum speed.**

To prevent this, the (former) master differential pressure sensor's signal can be looped through. In normal double pump operation, the presence of sensor signals on the slave has no effect.

→ Mains off/mains on

During a communication interruption on the (former) slave, if emergency operation is discontinued due to "mains off, mains on", the (former) slave will start up with the latest emergency operation settings received from the master (for example, constant speed with preset speed or "off").

Master pump behaviour

Emergency operation at the master pump discontinued:

→ Factory settings restored

During a communication interruption on the (former) master, if the factory settings are restored, it will start up with the factory settings of a single pump. It will then run in Δp -c mode at about half the maximum delivery head.

→ Mains off/mains on

During a communication interruption on the (former) master, if emergency operation is discontinued via mains off/mains on, the (former) master will start up with the most recent settings it has received from the twin-head pump configuration.

4.3.4 Disabling or enabling a pump

This function is only available with twin-head pump operation. A particular pump can generally be enabled or disabled for operation in menu <5.1.4.0>. A disabled pump cannot be operated until the disabling has been manually lifted.

The setting can be made directly at each pump or over the infrared interface. If a pump (master or slave) is disabled, the pump is no longer ready for operation.

In this state, errors are identified, displayed and reported. If a fault occurs in the enabled pump, the disabled pump does not start up. However, the pump kick is still performed if it is activated. The interval to the pump kick starts when the pump is disabled.

**NOTICE****If a pump head is disabled and "parallel operation" operating mode is activated:**

It cannot be guaranteed that the desired duty point will be achieved with just one pump head.

4.4 Other functions**4.4.1 Pump kick****NOTICE****If the pump is at a standstill for prolonged periods, the impeller may seize up in the pump housing.**

The pump kick reduces this risk. This is intended to ensure pump operation after a long standstill. If the "pump kick" function is deactivated, smooth starting of the pump can no longer be guaranteed.

A pump kick takes place after a configurable time has elapsed since a pump or pump head stopped operating. The interval can be set manually in menu <5.8.1.2> on the pump for a period of between 2 h and 72 h, in 1 h steps. Factory setting: 24 h.

The reason for the standstill is irrelevant. The pump kick is repeated until the pump is switched back on via a control mechanism.

For double pump function ("Main/standby operation" mode), this also applies to the standby pump. If the time interval before pump cycling set in menu <5.8.1.2> expires, a pump kick takes place at the standby pump.

The “pump kick” function can be disabled via menu <5.8.1.1>. As soon as the pump is switched on via the control system, the countdown to the next pump kick is interrupted.

A pump kick lasts 5 seconds, during which time the motor turns at the set speed. The speed can be set between the minimum and maximum permissible pump speeds in menu <5.8.1.3>. Factory setting: minimum speed.



NOTICE

If the “Operation” function has been chosen for EBM/SBM, each pump kick produces a signal. The signal is visible for a few seconds each time.



NOTICE

In the event of a malfunction too, the system will also attempt to perform a pump kick.

The time remaining until the next pump kick can be seen on the display in menu <4.2.4.0>. This menu is only available when the motor is stopped. The number of pump kicks is shown in menu <4.2.6.0>. With the exception of warnings, all faults detected during a pump kick will cause the motor to be switched off. The corresponding error code is shown on the display.

4.4.2 Overload protection

The pumps are equipped with an electronic overload protection function which switches off the pump in the event of an overload.

The electronic modules are equipped with a non-fading memory for data storage purposes. The data is retained no matter how long the module is disconnected from the power supply. When the voltage supply is re-established, the pump continues to run with the default values prior to disconnection from the power supply.

4.4.3 Switching frequency

The switching frequency can be changed via menu <4.1.2.0>, the CAN bus or the IR-Stick.



NOTICE

At high ambient temperatures, the thermal load on the electronic module can be reduced by lowering the switching frequency. Carry out switchovers or changes only when the pump is at a standstill (not when the motor is running).

Lower switching frequencies result in increased noise levels.

4.5 Variants

If menu <5.7.2.0> “pressure value correction” is not available for a pump, the pump in question is a variant version.

In that case, the following functions are unavailable:

- Pressure value correction (menu <5.7.2.0>)
- Efficiency-optimised activation and deactivation in twin-head pumps
- Flow rate trend display

4.6 Type key

Example: Yonos GIGA-N 40/200-15/2-R1-P5	
Yonos	Product family
GIGA	Series
N	Construction
40	Nominal diameter DN of pressure port
200	Nominal diameter of the impeller in mm
15	Rated power P ₂ in kW
2	Number of poles
R1	Version without differential pressure measurement

Example: Yonos GIGA-N 40/200-15/2-R1-P5

P5	Option: empty = with spacer coupling P5 = without spacer coupling (with standard coupling)
----	--

4.7 Technical data

Property	Value	Remarks
Speed range	750 ... 2900 rpm 380 ... 1450 rpm	Depending on pump type
Nominal diameters DN	32, 40, 50, 65, 80, 100, 125, 150 (dis-charge side)	
Pipe connections	Flanges PN 16	EN 1092-2
Permissible min./max. fluid temperature	-20 °C ... +140 °C	Depending on the fluid
Ambient temperature min./max.	0 ... +40 °C	Lower or higher ambient temperatures on request
Storage temperature min./max.	-20 °C ... +60 °C	
Max. permitted operating pressure	16 bar	
Insulation class	F	
Protection class	IP55	
Electromagnetic compatibility		
Emitted interference in acc. with:	EN IEC 61800-3:2018/IEC	Industrial environment (C2)
Interference resistance in acc. with:	61800-3:2017	
Sound-pressure level ¹⁾	$L_{pA, 1m} < 83 \text{ dB(A)} \mid \text{ref. } 20 \mu\text{Pa}$	Depending on pump type
Permissible fluids ²⁾	Heating water according to VDI 2035	Standard version
	Cooling/cold water	Standard version
	Water-glycol mixture up to 40% vol.	Standard version
Electrical connection	3~380 V -5 %/+10 %, 50/60 Hz	Supported mains types ³⁾ : TN, TT
	3~400 V ± 10 %, 50/60 Hz	
	3~440 V ± 10 %, 50/60 Hz	
Internal electric circuit	PELV, galvanically isolated	
Speed control	Built-in frequency converter	
Relative humidity	At $T_{\text{ambient}} = 30 \text{ °C}$: < 90 %, non-condensing	
	At $T_{\text{ambient}} = 40 \text{ °C}$: < 60 %, non-condensing	

¹⁾ Average value of the sound-pressure levels on a spatially rectangular measuring surface at a distance of 1 m from the pump surface in accordance with DIN EN ISO 3744.

²⁾ For more information about permissible fluids, see the "Fluids" section on the next page.

³⁾ Electronic modules for IT networks are optionally available for motor power from 11 ... 22 kW. Compliance with the specified values according to EN 61800-3 can only be guaranteed for the standard version of TN/TT networks. Non-observance can result in EMC faults.

Table 2: Technical data

Pumped fluids

Take account of the fact that water-glycol mixtures or fluids with a different viscosity from pure water increase the power consumption of the pump. Only use mixtures with corrosion protection inhibitors. **Observe relevant manufacturer specifications!**

- The fluid must be sediment-free.
 - The use of other fluids requires approval from Wilo.
 - Mixtures with a proportion of glycol of > 10 % influence the flow calculation.
 - In systems built according to the state of the technology, under normal system conditions it can be assumed that the standard seal/standard mechanical seal is compatible with the fluid.
- Special circumstances may require special seals, for example:
- Solid materials, oils or EPDM-corrosive substances in the fluid,
 - air in the system etc.

**NOTICE**

The flow value that is shown on the IR-Monitor/IR-Stick display or output to the building management system must not be used to control the pump. This value is merely an indicator of general trends.

A flow value is not output by every pump type.

Always read and follow the material safety data sheet for the fluid being pumped!**4.8 Scope of delivery**

- Wilo-Yonos GIGA-N pump
- Installation and operating instructions

4.9 Accessories

Accessories have to be ordered separately.

- IR-Monitor
- IR-Stick
- PLR IF module for connecting to PLR/interface converter
- LON IF module for connecting to the LONWORKS mains network
- BACnet IF module
- Modbus IF module
- CAN IF module
- DPS sets

**NOTICE**

IF module may only be inserted when the pump is de-energised (voltage-free).

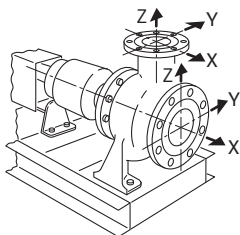
4.10 Permissible forces and torques on the pump flanges

Fig. 8: Permissible forces and torques on the pump flanges – pump made of grey cast iron

DN	Forces F [N]				Torques M [Nm]			
	F _x	F _y	F _z	Σ Forces F	M _x	M _y	M _z	Σ Torques M
Pressure port								
32	315	298	368	578	385	263	298	560
40	385	350	438	683	455	315	368	665
50	525	473	578	910	490	350	403	718
65	648	595	735	1155	525	385	420	770
80	788	718	875	1383	560	403	455	823
100	1050	945	1173	1838	613	438	508	910
125	1243	1120	1383	2170	735	525	665	1068
150	1575	1418	1750	2748	875	613	718	1278
Suction port								
50	578	525	473	910	490	350	403	718
65	735	648	595	1155	525	385	420	770
80	875	788	718	1383	560	403	455	823
100	1173	1050	945	1838	613	438	508	910
125	1383	1243	1120	2170	735	525	665	1068
150	1750	1575	1418	2748	875	613	718	1278
200	2345	2100	1890	3658	1138	805	928	1680

Values in acc. with ISO/DIN 5199 – class II (2002) – Appendix B, Family no. 1A.

Table 3: Permissible forces and torques on the pump flanges

If not all working loads reach the maximum permitted values, one of these loads may exceed the normal limit value. This is under the condition that the following additional conditions are fulfilled:

- All force and torque components are limited to 1.4 times the maximum permitted value.

→ The forces and torques acting on each flange meet the requirements of the compensation equation.

$$\left(\frac{\sum |F|_{\text{effective}}}{\sum |F|_{\text{max. permitted}}} \right)^2 + \left(\frac{\sum |M|_{\text{effective}}}{\sum |M|_{\text{max. permitted}}} \right)^2 \leq 2$$

Fig. 9: Compensation equation

$\Sigma F_{\text{effective}}$ and $\Sigma M_{\text{effective}}$ are the arithmetic sums of the effective values of both pump flanges (inlet and outlet). $\Sigma F_{\text{max. permitted}}$ and $\Sigma M_{\text{max. permitted}}$ are the arithmetic sums of the maximum permitted values of both pump flanges (inlet and outlet). The algebraic signs of ΣF and ΣM are not taken into consideration in the compensation equation.

5 Transportation and storage

5.1 Delivery

The pump is secured to a pallet ex works and is protected against dirt and moisture.

Check the shipment immediately on receipt for defects (damage, completeness). Defects must be noted on the freight documentation. Any defects must be notified to the transport company or the manufacturer immediately on the day of receipt of shipment. Subsequently notified defects can no longer be asserted.

5.2 Transport



DANGER

Risk of fatal injury due to suspended loads!

Never allow anyone to stand under suspended loads! Danger of (serious) injuries caused by falling parts. Loads may not be carried over work places where people are present!

The safety zone must be marked so that there is no danger when the load (or part of it) slips away or if the lifting device snaps or is ripped off.

Loads must never be suspended for longer than necessary.

Accelerations and braking during the lifting operation must be performed in a way that rules out any danger to people.



WARNING

Hand and foot injuries due to lack of protective equipment!

Danger of (serious) injuries during work. Wear the following protective equipment:

- Safety shoes
- Safety gloves for protection against cuts
- Sealed safety goggles
- Safety helmet must be worn if lifting equipment is used!



NOTICE

Use only properly functioning lifting equipment!

Use only properly functioning lifting equipment to lift and lower the pump. Ensure that the pump does not become jammed during lifting and lowering. Do **not** exceed the maximum bearing capacity of the lifting equipment! Check that lifting equipment is functioning properly before use!

CAUTION

Property damage due to incorrect transport

To ensure proper alignment, all equipment is pre-assembled. If dropped or if improperly handled, there is a risk of misalignment or deficient performance due to de-

formations. The pipes and valves will not withstand loads and should not be used to secure loads in transit.

- Only use permitted lifting gear for transport. Ensure the stability of the load since, with this particular pump design, the centre of gravity is shifted to the top (top-heavy).
- **Never** attach lifting gear to shafts in order to lift the unit.
- Do **not** use the transport lugs on the pump or motor to lift the entire unit. They are only meant for transporting the individual components during installation or dismantling.

Only remove the outer packaging at the place of utilisation to ensure that the pump is not damaged during transport.

CAUTION

Risk of damage due to incorrect packaging.

If the pump is transported again at a later date, it must be packaged so that it cannot be damaged during transport. Use the original packaging for this, or choose equivalent packaging.

5.2.1 Attaching the unit

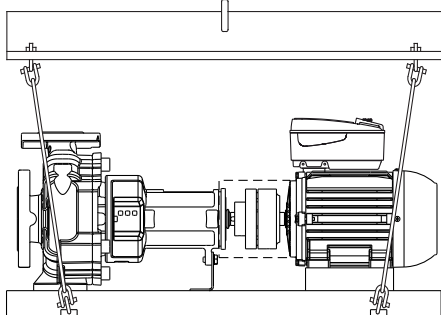


Fig. 10: Attaching the unit

- Comply with applicable national safety regulations.
- Use legally specified and approved lifting gear.
- Select the lifting gear based on the prevailing conditions (weather, attachment point, load, etc.).
- Only attach the lifting gear to the attachment point. Fix in place with a shackle.
- Never feed the lifting gear over or through transport lugs without protection.
- Never feed the lifting gear over sharp edges without protection.
- Use lifting equipment with sufficient bearing capacity.
- The stability of the lifting equipment must be ensured during operation.
- When using lifting equipment, ensure a second person is present to coordinate the procedure if required (e.g. if the operator's field of vision is blocked).
- When lifting, make sure that the load limit of the lifting gear is reduced when pulling at an angle. The safety and efficiency of the lifting gear is best guaranteed when all load-bearing elements are loaded vertically. If necessary, use a lifting arm, to which the lifting gear can be vertically attached.
- **Ensure the load is lifted vertically!**
- **Prevent the suspended load from swinging!**

5.3 Storage



NOTICE

Improper storage can lead to damage to the equipment.

Damage caused by improper storage is not covered by the guarantee or warranty.

- Requirements at the storage location:
 - dry
 - clean
 - well-ventilated
 - free from vibrations
 - free from humidity
 - free from rapid or extreme changes in temperature
- Store the product where it is protected against mechanical damage.
- Protect the bearings and couplings from sand, gravel and other foreign materials.
- Lubricate the unit to prevent rust and bearing seizure.
- Manually rotate the drive shaft several times once a week.

Storage for more than three months

Additional precautionary measures:

- All rotating parts must be coated with a suitable protective medium to protect them from rust.

- Rotate pump shaft once a week to prevent scoring at the bearings and sticking.
- If the pump is to be stored for more than a year, consult Wilo and ask what action should be taken to conserve the pump.

6 Installation and electrical connection

6.1 Personnel qualifications

- Electrical work: A qualified electrician must carry out the electrical work.

6.2 Operator responsibilities

- Observe locally applicable accident prevention and safety regulations of professional and trade associations.
- Observe all regulations for working with heavy loads and under suspended loads.
- Provide protective equipment and ensure that the protective equipment is worn by personnel.
- Avoid pressure surges!
Pressure surges can occur in long pressure pipes. These pressure surges can lead to the destruction of the pump!
- Structural components and foundations must be of sufficient stability in order to allow the device to be fixed in a secure and functional manner. The operator is responsible for the provision and suitability of the building/foundation!
- Check that the available consulting documents (installation plans, design of the operating space, inflow conditions) are complete and correct.

6.3 Preparing the installation



WARNING

Improper handling involves risk of personal injury and material damage!

- Never set up the pump unit on unpaved surfaces or surfaces that cannot bear loads.
- Flush the pipe system if required. Dirt can cause the pump to fail.
- Install only after all welding and soldering work has been completed and the pipe system has been flushed, if required.
- Observe the minimum axial distance between a wall and the fan cover of the motor: 200 mm + diameter of the fan cover
- Ensure air can flow freely to the heat sink of the electronic module.

- The pumps (in the standard version) must be protected from the weather and installed in a frost/dust-free, well-ventilated environment that is not potentially explosive.
- Mount the pump in a readily accessible place. This makes it easier to carry out inspections, maintenance (e.g. mechanical seal change) or replacement in the future.
- A travelling crane or device for attaching hoisting gear should be installed above the set-up location of large pumps.

6.4 Installing the pump unit on a base

CAUTION

Danger of property and material damage!

A missing foundation or incorrect installation of the unit on the base can lead to a malfunction of the pump. Incorrect installation is not covered by the warranty.

- Only have the pump unit installed by qualified personnel.
- A professional from the concrete sector must be hired for all base work.

6.4.1 Base

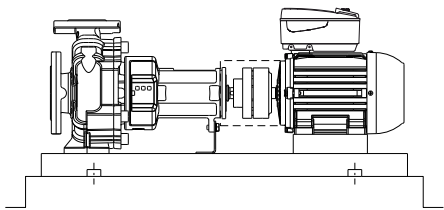


Fig. 11: Installing the unit on a base

The base must be able to permanently support the unit installed on the baseplate. The base must be level to ensure there is no tension on the baseplate or unit. Wilo recommends constructing it using premium, non-shrink concrete of an adequate thickness. This will prevent vibrations from being transmitted.

The base must be able to absorb the forces, vibrations and impacts that occur.

Guidance values for dimensioning the base:

- Approx. 1.5 – 2 times heavier than the unit.
- The width and length should each be about 200 mm longer than those of the baseplate.

The baseplate must not be strained or pulled down onto the surface of the base. It must be supported in such a way that the original alignment is not changed.

Prepare drilled holes for the anchor bolts. Position pipe sleeves vertically in the base at the corresponding points. Diameter of the pipe sleeves: roughly 2½ times the diameter of the screws. This allows the screws to be moved in order to reach their final positions.

Wilo recommends laying the base initially up to about 25 mm below the planned height. The surface of the concrete base must be well contoured before it hardens. Remove the pipe sleeves after the concrete hardens.

When the baseplate is laid, insert steel rods vertically into the base at regular intervals. The required number of steel rods is dependent on the size of the baseplate. The rods must project into the baseplate by up to 2/3.

6.4.2 Preparing the baseplate for anchoring

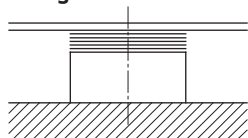


Fig. 12: Shims on the base surface

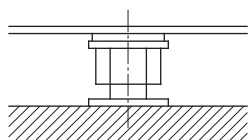


Fig. 13: Levelling screws on the base surface

- Thoroughly clean the base surface.
- Place shims (approx. 20 – 25 mm thick) on every screw hole on the base surface. Alternatively, levelling screws can also be used.
- For a length spacing of the fixation bores ≥ 800 mm, shims should be additionally placed in the middle of the baseplate.
- Apply the baseplate and level in both directions with additional shims.
- Align the unit when installing on the base using a spirit level (at the shaft/pressure port).
The baseplate must be horizontal; tolerance: 0.5 mm per metre.
- Fit anchor bolts in the provided drilled holes.



NOTICE

The anchor bolts must fit in the fastening bores of the baseplate.

They must meet the relevant standards and be sufficiently long, so that a firm fit in the base is guaranteed.

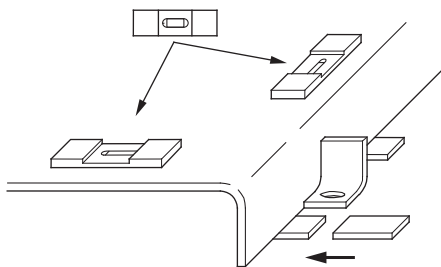


Fig. 14: Levelling and aligning the baseplate

- Pour in anchor bolts with concrete. After the concrete has set, tighten the anchor bolts evenly and firmly.
- Align the unit so that the pipes can be connected to the pump stress-free.

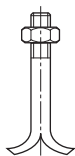


Fig. 15: Anchor bolt

6.4.3 Pouring out the baseplate

The baseplate can be poured out after fixing. The process of pouring out reduces vibrations to a minimum.

- Wet the base surface before pouring out the concrete.
- Use a suitable, non-shrink mortar for pouring out.
- Pour the mortar through the openings in the baseplate. Be sure to avoid hollow spaces.
- Plank the base and baseplate.
- After curing, check the anchor bolts for a tight fit.
- Coat the unprotected surfaces of the base to protect from moisture.

6.5 Pipework

The pipe connections of the pump are fitted with dust caps so that no foreign objects can penetrate during transport and installation.

- These caps must be removed before connecting the pipes.

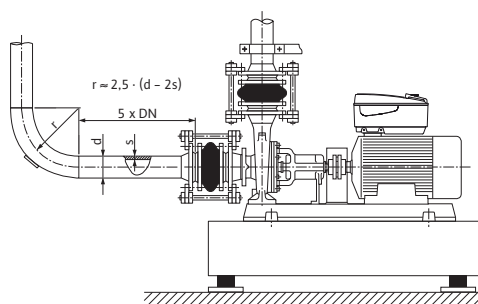


Fig. 16: Connect the pump voltage-free, with settling section upstream and downstream of the pump

CAUTION

Incorrectly carried out pipework/installation can lead to material damage! Welding beads, cinder and other contaminants can damage the pump!

- The pipes must be sufficiently dimensioned, taking the pump inlet pressure into account.
- Connect the pump and pipes using suitable gaskets. Take the pressure, temperature and fluid into account. Check the gaskets for proper fitting.
- The pipes must not transfer any forces to the pump. Brace the pipes directly before the pump and connect them without tension.
- Observe the permissible forces and torques on the pump connecting pieces!
- The expansion of the pipes in the event of a temperature rise is to be compensated by suitable means.
- Avoid air pockets in piping by means of appropriate installations.



NOTICE

Make subsequent work on the unit lighter!

- To ensure the entire unit does not have to be emptied, install a non-return valve and shut-off valves before and after the pump.



NOTICE

Avoid flow cavitation!

- A settling section must be provided upstream and downstream of the pump in the form of a straight pipe. The length of the settling section must be at least 5 times the nominal diameter of the pump flange.

- The pipes and pump must be free of mechanical stress when installed.
- The pipes must be fixed in such a way that the pump does not have to support the weight of the pipes.
- Clean, flush and purge the unit before connecting the pipes.
- Remove the covers from the suction and discharge ports.
- If required, install a dirt filter upstream of the pump in the pipe on the suction side.
- Then connect the pipes to the pump connecting pieces.

6.6 Aligning the unit

CAUTION

Incorrect alignment can result in property damage!

The transport and installation of the pump can affect the alignment. The motor must be aligned to the pump (not vice versa).

- Check the alignment before the first start.

CAUTION

Changes to the alignment during operation can result in property damage.

The pump and motor are usually aligned at ambient temperature. Thermal expansion at operating temperature can change the alignment, particularly in the case of very hot fluids.

Adjustment may be required if the pump is required to pump very hot fluids:

- Allow the pump to run at the actual operating temperature.
- Switch off the pump then immediately check the alignment.

Precondition for reliable, smooth and efficient operation of a pump unit is proper alignment of the pump and the drive shaft.

Misalignments can be the cause of:

- excessive noise development during pump operation
- vibrations
- premature wear
- excessive coupling wear

6.6.1 Coupling alignment

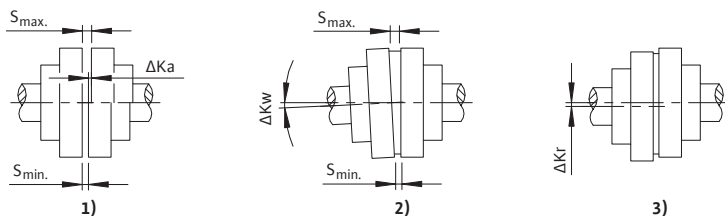


Fig. 17: Coupling alignment without spacer

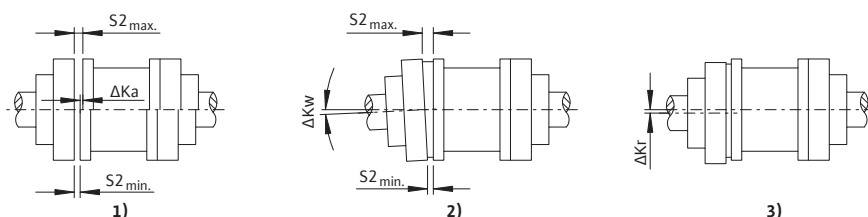


Fig. 18: Coupling alignment with spacer

1. Axial displacement (ΔK_a)

- Adjust the gap ΔK_a within the permissible range of deviation.
Permissible deviations for dimensions S and S2, see table “Permissible gaps S and S2”

2. Angular displacement (ΔK_w)

The angular displacement ΔK_w can be measured as the difference between the gaps:
 $\Delta S = S_{\max} - S_{\min}$ and/or $\Delta S2 = S2_{\max} - S2_{\min}$.

The following condition must be met:

ΔS and/or $\Delta S2 \leq \Delta S_{\text{perm}}$. (perm. = permissible; ΔS_{perm} is dependent on the speed)

If required, the permissible angular displacement ΔK_w can be calculated as follows:

$$\Delta K_{w_{\text{perm.}}} \text{ in RAD} = \Delta S_{\text{perm.}} / DA$$

$$\Delta K_{w_{\text{perm.}}} \text{ in GRD} = (\Delta S_{\text{perm.}} / DA) \times (180/\pi)$$

(with $\Delta S_{\text{perm.}}$ in mm, DA in mm)

3. Radial displacement (ΔK_r)

The permissible radial displacement $\Delta K_{r_{\text{perm.}}}$ can be taken from the table “Maximum permissible shaft displacement”. Radial displacement is dependent on the speed. The numerical values in the table and their interim values can be calculated as follows:

$$\Delta K_{r_{\text{perm.}}} = \Delta S_{\text{perm.}} = (0.1 + DA/1000) \times 40/\sqrt{n}$$

(with speed n in rpm, DA in mm, radial displacement $\Delta K_{r_{\text{perm.}}}$ in mm)

Coupling size	DA [mm]	S [mm]	S2 [mm]
68	68	2 ... 4	5
80	80	2 ... 4	5
95	95	2 ... 4	5
110	110	2 ... 4	5
125	125	2 ... 4	5
140	140	2 ... 4	5
160	160	2 ... 6	6
180	180	2 ... 6	6
200	200	2 ... 6	6

(“S” for couplings with a spacer and “S2” for couplings with a spacer)

Table 4: Permissible gaps S and S2

Coupling size	$\Delta S_{\text{perm.}}$ and $\Delta K_{r_{\text{perm.}}}$ [mm]; speed dependent			
	1500 rpm	1800 rpm	3000 rpm	3600 rpm
68	0.20	0.20	0.15	0.15
80	0.20	0.20	0.15	0.15
95	0.20	0.20	0.15	0.15
110	0.20	0.20	0.15	0.15
125	0.25	0.20	0.15	0.15
140	0.25	0.25	0.20	0.15
160	0.30	0.25	0.20	0.20
180	0.30	0.25	0.20	0.20
200	0.30	0.30	0.20	0.20

Permissible shaft displacement $\Delta S_{\text{perm.}}$ and $\Delta K_{r_{\text{perm.}}}$ in mm (during operation, rounded)

Table 5: Maximum permissible shaft displacement $\Delta S_{\text{perm.}}$ and $\Delta K_{r_{\text{perm.}}}$.

Checking the radial alignment

- Firmly clamp a dial gauge to one of the couplings or to the shaft. The piston of the dial gauge must lie against the crown of the other half-coupling.
- Set the dial gauge to zero.
- Turn the coupling and write down the measuring result after every quarter turn.
- Alternatively, the radial coupling alignment can also be checked with a ruler.

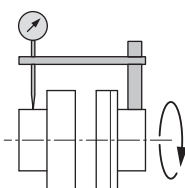


Fig. 19: Checking the radial alignment with a comparator

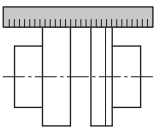


Fig. 20: Checking the radial alignment with a ruler



NOTICE

The radial deviation of the two coupling halves must not exceed the maximum values found in table “Maximum permissible shaft displacement $\Delta S_{perm.}$ and $\Delta K r_{perm.}$ ”. This requirement applies to every operating status – including operating temperature and inlet pressure.

Checking the axial alignment



NOTICE

The axial deviation of the two coupling halves must not exceed the maximum values found in table “Permissible gaps S and S2”. This requirement applies to every operating status – including operating temperature and inlet pressure.

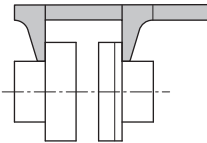


Fig. 21: Checking the axial alignment with a calliper gauge

Using a calliper gauge, circumferentially check the distance between the two coupling halves.

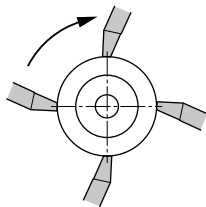


Fig. 22: Checking the axial alignment with a calliper gauge – circumferential check

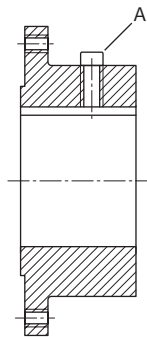


Fig. 23: Adjusting screw A for axial safeguard

- Connect the coupling halves once correctly aligned.
The tightening torques for the coupling are listed in the table “Tightening torques for adjusting screws and coupling halves”.
- Install the coupling guard.

Coupling parameter d [mm]	Tightening torque for adjusting screw A [Nm]	Tightening torque for adjusting screw B [Nm]
80, 88, 95, 103	4	13
110, 118	4	14
125, 135	8	17.5
140, 152	8	29
160, 172	15	35
180, 194	25	44
200, 218	25	67.5
225, 245	25	86
250, 272	70	145

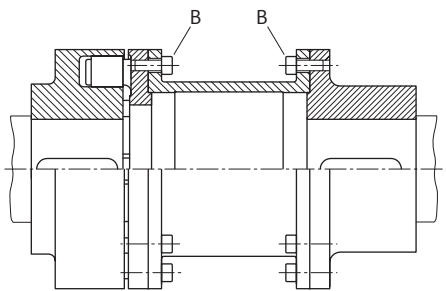


Fig. 24: Fastening screws B of coupling halves

6.6.2 Alignment of the pump unit

Any deviations in the measuring results indicate a misalignment. In this case, the unit must be realigned to the motor.

- Loosen the hexagon head screws and counter nuts on the motor.
- Place shims under the motor feet until the height difference is compensated.
- Pay attention to the axial alignment of the coupling.
- Tighten the hexagon head screws again.

→ Finally, check the functioning of the coupling and shaft. The coupling and shaft must be easy to turn by hand.

→ After correct alignment, mount the coupling guard.

For tightening torques for the pump and motor on the baseplate, see "Screw tightening torques for pump and motor" table.

Screw:	M6	M8	M10	M12	M16	M20	M24
Tightening torque [Nm]	10	25	35	60	100	170	350

Table 7: Screw tightening torques for pump and motor

CAUTION

Risk of damage due to vibrations! Incorrect alignment can lead to vibrations.

Vibrations can damage or destroy individual components.

- Carefully align the pump unit until all measurement results are within the permissible range.

6.7 Electrical connection



DANGER

Risk of fatal injury due to electrical current!

Improper conduct when carrying out electrical work can lead to death due to electric shock!

- The electrical connection should only be established by an electrician approved by the local electricity supplier.
- Observe the locally applicable regulations.
- Before beginning work on the product, make sure that the pump and drive are electrically isolated.
- Make sure that no one can turn on the power supply again before work is completed.
- Make sure that all energy sources can be isolated and locked. If the pump was switched off by a safety device, it must be secured against switching back on again until the error has been remedied.
- Electrical machines must always be earthed. Earthing must be appropriate for the drive and meet the relevant standards and regulations. Earth terminals and fixation elements must be suitably dimensioned.
- Connection cables must **never** touch the piping, pump or motor housing.
- If it is possible for persons to come into contact with the pump or the pumped fluid, the earthed connection must also be fitted with a residual current circuit breaker.
- Observe the manufacturer's installation and operating instructions for the accessories!



DANGER

Risk of fatal injury due to contact voltage! Even when it is disconnected, high contact voltages can still occur in the electronic module due to non-discharged capacitors.

Touching live parts will result in serious injuries or death!

- Before working on the pump, disconnect the power supply and wait for 5 minutes.
- Check whether all connections (including potential-free contacts) are voltage-free.
- Never poke around in the openings of the electronic module or insert anything into them!
- Reinstall removed safety devices (such as module covers)!



WARNING

Risk of mains overload! An inadequate mains design can lead to system failures and cable fires due to mains overload.

Short-term simultaneous operation of all pumps is possible in multi-pump operation.

Take multi-pump operation into account when designing the network, especially with regard to the cable cross-sections and fuses used. Each drive must have its own supply line with separate fuse protection!

CAUTION

Risk of material damage if the electronic module is not installed!

Normal operation of the pump is only permitted with the electronic module installed!

The pump must not be connected or operated without the electronic module being installed!

CAUTION**Risk of material damage caused by improper electrical connection!**

Ensure that the current type and voltage of the mains connection correspond to the specifications on the pump rating plate.

6.7.1 Fuse on mains side**Comply with the regulations of the local energy supply company!**

Maximum permissible fuse protection, see following table; observe the rating plate data!

Power P_N	Max. fuse [A]
1.5 ... 11 kW	25
15 kW	35
18.5 ... 22 kW	50

Table 8: Maximum permissible fuse protection

Circuit breaker

The use of a circuit breaker is recommended.

**NOTICE**

Circuit breaker trigger characteristic: B




Overload: $1.13 - 1.45 \times I_{nom}$

Short-circuit: $3 - 5 \times I_{nom}$

Residual-current device (RCD)

This pump is equipped with a frequency converter. This means it may not be protected by a residual-current device. Frequency converters can impair the functioning of residual current-operated protection circuits.

Exception: residual-current devices which have a selective type B universal current-sensitive design are allowed:

→ Labelling:   

→ Trigger current

– < 11 kW: > 30 mA

– ≥ 11 kW: > 300 mA

6.7.2 Electromagnetic compatibility

The IEC 61000-3-12 standard regulates the connection to the public low voltage supply network.

Pumps in efficiency classes 11 ... 22 kW are devices for professional use. They are subject to special connection conditions, as an R_{SCE} of 33 at the connection point is insufficient to operate them. The pumps have been assessed based on table 4 of the standard ("three-phase devices under special conditions").

Pumps in efficiency classes 11 ... 22 kW only comply with the standard IEC

61000-3-12:2011 if the following condition is met at all public connection points:

→ At the interface between the electrical installation of the user and the public power supply network, the short-circuit power S_{SC} must be greater than or equal to the values listed in the following table!

Motor power [kW]	Short-circuit power S_{SC} [kVA]
11	≥ 1800
15	≥ 2400
18.5	≥ 3000
22	≥ 3500

Table 9: Required short-circuit power S_{SC}

The installer or user must ensure that these pumps are operated properly. If necessary, consult the network operator. In the event of industrial use on a factory-owned medium-voltage outlet, responsibility for the connection conditions lies exclusively with the operator.



NOTICE

A suitable harmonic filter between the pump and supply network reduces the amount of harmonic current.

The Yonos GIGA-N pump must be fitted with an additional earthing! Fit the additional earthing to the motor base or baseplate (on the motor side).

6.7.3 Preparing the electrical connection

Establish an electrical connection via a stationary mains cable. The mains cable must have a plug device or an all-pole switch with a contact opening width of at least 3 mm.

If flexible cables are used, e.g. mains connection cables or communication cables, use ferrules.

Always lead the mains cable through the designated threaded cable gland (M25 or M40)!

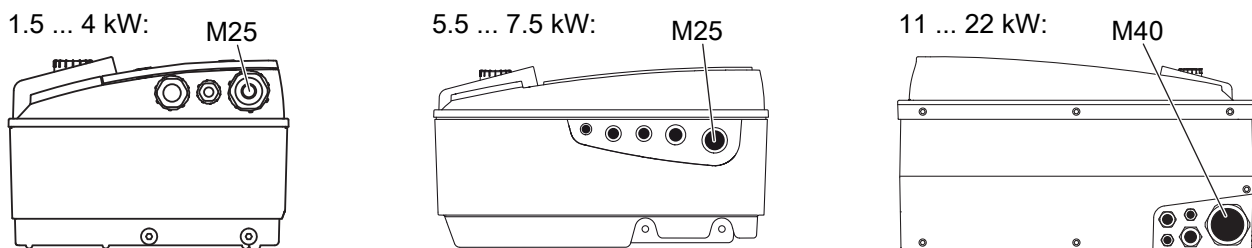


Fig. 25: Threaded cable glands for mains connection cable

Power P _N [kW]	Cable cross-section [mm ²]	PE [mm ²]
1.5 ... 4 kW	1.5 ... 4	2.5 ... 4
5.5/7.5 kW	2.5 ... 6	4 ... 6
11 kW	4 ... 6	6 ... 35
15 kW	6 ... 10	
18.5/22 kW	10 ... 16	

Table 10: Cable cross-sections



NOTICE

Tightening torques for the terminal screws, see table “Tightening torques for threaded cable glands”.

Only use a calibrated torque wrench.

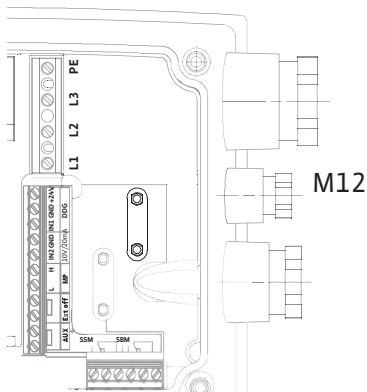
In order to comply with electromagnetic compatibility standards, the following cables must always be shielded:

- Differential pressure sensor (DPS) (if installed on-site)
- In2 (setpoint)
- DP communication for cable lengths > 1 m (DP = dual-pump; “MP” terminal)
Observe polarity:
MA = L => SL = L
MA = H => SL = H
- EXT. Off
- AUX
- Communication cable IF module

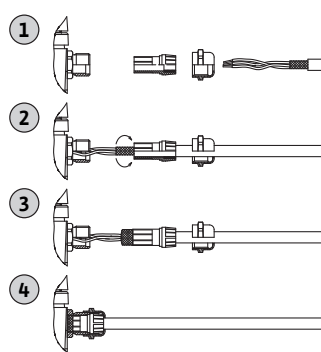
The shield must be applied to the EMC cable clips in the electronic module **and** to the other end. The cables for SBM and SSM do not have to be shielded.

Connect shield in/on electronic module

1.5 ... 4 kW:



5.5 ... 7.5 kW:



11 ... 22 kW:

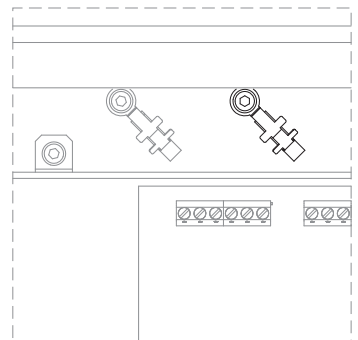


Fig. 26: Connect shield

- With a motor power of < 5.5 kW: in the electronic module on the earth rails
- With a motor power of 5.5 kW and 7.5 kW: on the cable gland
- With a motor power of ≥ 11 kW: on the cable terminals above the terminal strip

In order to ensure drip protection and strain relief on the cable connections, only cables with a suitable outer diameter may be used (for the required cross-section, please see the table “Cable cross-sections”).

Secure cable glands tightly.

Ensure that no drips can run into the electronic module:

- Bend the cables into a drain loop near the threaded cable gland
- Unused cable glands should be sealed with the sealing washers provided and screwed tight.

The mains cable should be laid in such a way that it can under no circumstances come into contact with the pipe and/or the pump and motor housing. When pumps are used with fluid temperatures above 90°C, a mains cable with suitable thermal resistance must be used.

Note additional earthing!

Tightening torques for union nuts of the threaded cable glands

Thread	Tightening torque [Nm] ± 10 %	Installation information
M12x1.5	3.0	1x threaded cable gland M12 reserved for connecting cable for an optional differential pressure sensor
M16x1.5	6.0	
M20x1.5	8.0	
M25x1.5	11.0	
M40x1.5	16.0	

Table 11: Tightening torques for threaded cable glands

6.7.4 Terminals

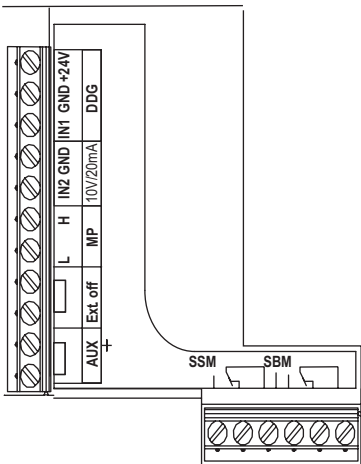


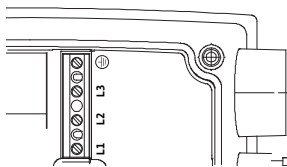
Fig. 27: Control terminals

Control terminals

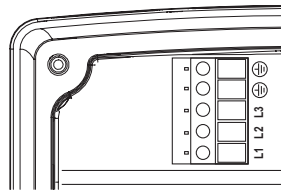
Please also see the following table “Terminal assignment”.

Power terminals (mains connection terminals)

1.5 ... 4 kW:



5.5 ... 7.5 kW:



11 ... 22 kW:

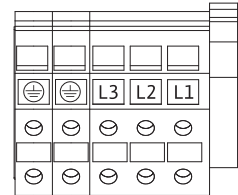


Fig. 28: Power terminals

Please also see the following table “Terminal assignment”.

Additional earthing



DANGER

Risk of fatal injury due to electrical current!

As motors from 11 kW generate more leakage current, improper electrical connections can lead to fatal electric shock!

- Motors from 11 kW must be additionally connected to a reinforced earth connection.

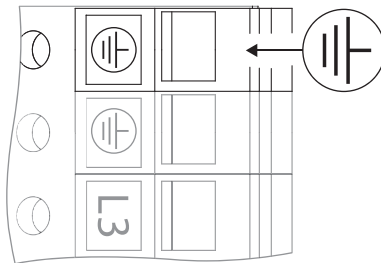


Fig. 29: Additional earthing, from 11 kW motor power

	Tightening torque [Nm] ± 10 %
Control terminals	0.5
Power terminals	
1.5 – 7.5 kW	0.5
11 – 22 kW	1.3

	Tightening torque [Nm] ± 10 %
Earth terminals	0.5

Table 12: Tightening torques for control, power and earth terminals

6.7.5 Terminal assignment

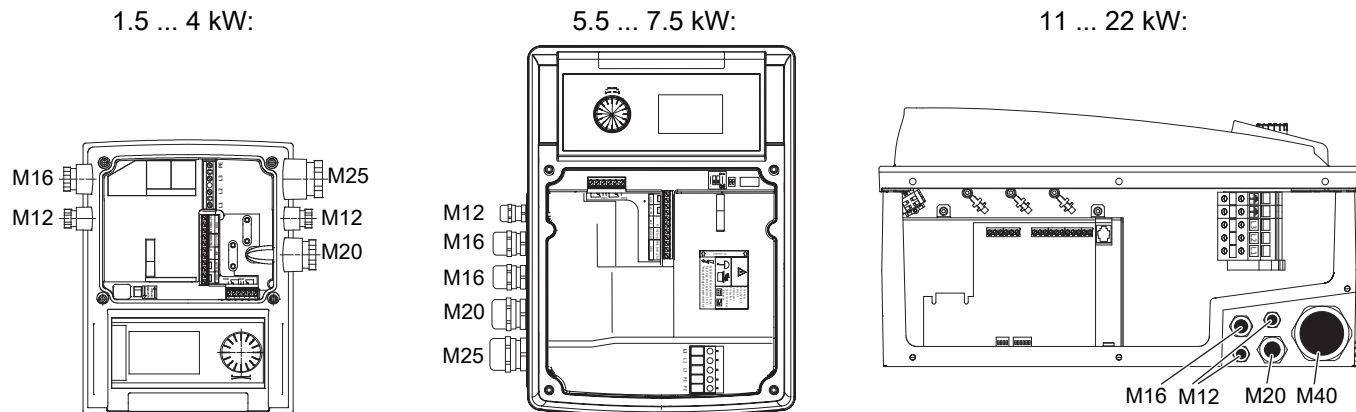


Fig. 30: Threaded cable glands

Designation	Assignment	Notes
L1, L2, L3	Mains connection voltage	3~380 V AC – 3~440 V AC, 50/60 Hz, IEC 38
⊖ (PE)	Protective earth conductor connection	
In1 (1) (input)	Actual value input	Type of signal: Voltage (0–10 V, 2–10 V) Input resistance: R _i ≥ 10 kΩ Type of signal: Current (0–20 mA, 4–20 mA) Input resistance: R _i = 500 Ω Can be configured in the service menu <5.3.0.0> Connected at the factory via the M12 threaded cable gland, via In1 (1), GND (2), + 24 V (3) according to the sensor cable designations (1, 2, 3).
In2 (input)	Setpoint input	In2 can be used as the input for remote adjustment of the setpoint in any operating mode. Type of signal: Voltage (0–10 V, 2–10 V) Input resistance: R _i ≥ 10 kΩ Type of signal: Current (0–20 mA, 4–20 mA) Input resistance: R _i = 500 Ω Can be configured in the service menu <5.4.0.0>
GND (2)	Earth connections	For both input In1 and In2
+ 24 V (3) (output)	DC voltage for an external consumer/signal transmitter	Max. load: 60 mA The voltage is short-circuit proof. Contact load: 24 V DC/10 mA
AUX	External pump cycling	Pump cycling can be performed using an external, potential-free contact. If external pump cycling has been previously activated, bridging the two terminals once executes a pump cycling operation. Bridging them a second time will cause the procedure to repeat, provided the minimum run time is adhered to. Can be configured in the service menu <5.1.3.2> Contact load: 24 V DC/10 mA
MP	Multi Pump	Interface for twin-head pump function
Ext. Off	“Overriding OFF” control input for external, potential-free switch	The pump can be switched on/off via the external potential-free contact. Systems with a high switching frequency (> 20 on/off operations per day) should be switched on/off via “External off”. Can be configured in the service menu <5.1.7.0> Contact load: 24 V DC/10 mA

Designation	Assignment	Notes
SBM	Individual run signal/collective run signal, readiness signal and “mains on” signal	Potential-free individual run signal/collective run signal (changeover contact), operation readiness signal is available at the SBM terminals (menus <5.1.6.0>, <5.7.6.0>). Contact load: minimum permitted: 12 V DC, 10 mA, maximum permitted: 250 V AC/24 V DC, 1 A
SSM	Individual/collective fault signal	Potential-free single/collective fault signal (changeover contact) is available at the SSM terminals (menu <5.1.5.0>). Contact load: minimum permitted: 12 V DC, 10 mA, maximum permitted: 250 V AC/24 V DC, 1 A
IF module interface	Terminals of the serial digital BA interface	The optional IF module is inserted into a multi-plug in the terminal box. The connection is twistproof.

Table 13: Terminal assignment

**NOTICE**

The terminals In1, In2, AUX, GND, Ext. off and MP meet the requirement for “safe isolation” according to EN 61800-5-1

- to the mains terminals
- and to the SBM and SSM terminals (and vice versa).

The control system is configured as a PELV (protective extra low voltage) circuit. This means that the (internal) supply meets the requirements for safe supply isolation; the GND is connected to PE.

6.7.6 Differential pressure sensor connection

Cable	Colour	Terminal	Function
1	black	In1	Signal
2	blue	GND	Earth
3	brown	+24 V	+24 V

Table 14: Differential pressure sensor cable connections

**NOTICE**

The electrical connection of the differential pressure sensor should be fed through the smallest threaded cable gland (M12) on the electronic module.

For twin-head pump operation in a Y-pipe installation, connect the differential pressure sensor to the master pump. Arrange the measuring points of the differential pressure sensor in the common collector pipe on the suction and discharge side of the Y-pipe installation

6.7.7 Making the electrical connection

- Make the connections in accordance with the terminal allocation.
- Earth the pump/installation as per regulations.
- **Reinstall any uninstalled safety devices, e.g. module cover!**

6.8 Protective devices

**WARNING****Risk of burns from hot surfaces!**

The spiral housing and the discharge cover assume the temperature of the fluid during operation. It may cause burns.

- Depending on the application, insulate the spiral housing.
- Provide corresponding guards.
- **Allow the pump to cool down at ambient temperature after switching it off!**
- Observe local regulations.

CAUTION**Risk of property damage due to incorrect insulation!**

The discharge cover and the bearing bracket must not be insulated.

7 Commissioning

**WARNING****Risk of injury due to lack of protective equipment!**

(Serious) injuries can occur due to lack of protective equipment.

- Do not remove the unit casings of moving parts (such as that of the coupling) during machine operation.
- Always wear protective clothing, protective gloves and protective goggles when working.
- Do not remove or disable the safety devices on the pump and motor.
- An authorised technician must check the functionality of the safety devices on the pump and motor prior to commissioning.

CAUTION**Risk of material damage due to unsuitable operating mode!**

Operating outside of the duty point impairs the pump efficiency and can damage the pump. Operating with the shut-off devices closed for more than 5 minutes is not recommended and generally dangerous in the case of hot fluids.

- The pump must not be operated outside of the specified operating range.
- Do not operate the pump with the shut-off devices closed.
- Make sure that the NPSHA value is always higher than the NPSHR value.

CAUTION**Risk of material damage due to the formation of condensate!**

When using the pump in air-conditioning or cooling applications, the formation of condensate can cause motor damage. The motors are equipped with condensate drainage holes, which are factory-sealed with plastic plugs.

- Open the condensate drainage holes in the motor housing at regular intervals and drain the condensate.
- Then reseal the condensate drainage holes with plastic plugs.

**NOTICE**

If the plastic plugs are removed, protection class IP55 is no longer ensured!

7.1 Personnel qualifications

- Electrical work: A qualified electrician must carry out the electrical work.
- Operation/control: Operating personnel must be instructed in the functioning of the complete system.

7.2 Filling and venting

**NOTICE**

The standard version of the Wilo-Yonos GIGA-N pump has no air vent valve. The suction line and pump are vented via a suitable venting device on the pressure flange of the pump. An optional air vent valve is available.

**WARNING****Risk of personal injury and material damage due to extremely hot or extremely cold pressurised fluid!**

Depending on the temperature of the fluid, when the venting device is opened completely, extremely hot or extremely cold fluid may escape in liquid or vapour form. Fluid may shoot out at high pressure depending on the system pressure.

- Make sure the venting device is in a suitable, secure position.
- Protect the electronic module from any water escaping when venting.
- Always exercise caution when opening the venting device.

Procedure for venting systems where the fluid level is above the suction port of the pump:

- Open the shut-off device on the discharge side of the pump.
- Slowly open the shut-off device on the suction side of the pump.
- To vent, open the venting device on the discharge side of the pump or on the pump.
- Close the venting device as soon as fluid escapes.

Procedure for filling/venting systems with a non-return valve, where the fluid level is below the suction port of the pump:

- Close the shut-off device on the discharge side of the pump.
- Open the shut-off device on the suction side of the pump.
- Fill in liquid through a funnel until the suction line and the pump are completely filled.

7.3 Twin-head pump installation/Y-pipe installation

**NOTICE**

For the initial commissioning of a Y-pipe installation that has not been preconfigured, both pumps are set to their factory setting. After connecting the twin-head pump communication cable, the error code "E035" is displayed. Both drives run at the emergency operation speed.



Fig. 31: Setting the master pump

After acknowledging the error message, menu <5.1.2.0> is displayed and "MA" (= master) flashes. In order to acknowledge "MA", access disable must be deactivated and service mode must be active. Both pumps are set to "master" and "MA" flashes on the displays of both electronic modules.

- Acknowledge one of the two pumps as master pump by pressing the operating button. The status "MA" appears on the display of the master pump.
- Close the differential pressure sensor at the master.

The measuring points of the differential pressure sensor must be on the suction and discharge side of the double-pump system in the common collector pipe. The other pump will display the status "SL" (= slave). All further pump settings must now be made via the master only.

**NOTICE**

To change the master pump manually later on, call up menu <5.1.2.0> (for navigation in the service menu, see "Navigating" chapter).

7.4 Setting of pump output

The system was designed for a certain duty point (full load point, calculated maximum heating load). During commissioning, set the pump output (delivery head) according to the duty point of the system.

The factory setting does not correspond to the output required for the system. The required pump output is determined with the help of the pump curve diagram for the selected pump type (e.g. from the data sheet).

**NOTICE**

The flow value that is shown on the IR-Monitor/IR-Stick display or output to the building management system must not be used to control the pump. This value is merely an indicator of general trends.

A flow value is not output by every pump type.

CAUTION**Risk of material damage!**

An inadequate volume flow can lead to damage on the mechanical seal; the minimum volume flow depends on the speed of the pump.

- Ensure that the volume flow does not fall below the minimum value Q_{\min} .
To calculate Q_{\min} :
 $Q_{\min} = 10 \% \times Q_{\max} \text{ pump} \times \text{actual speed}/\text{max. speed}$

7.5 Switching on the pump

CAUTION**Risk of material damage!**

- Do not operate the pump with the shut-off devices closed.
- Only operate the pump within the permissible operating range.

Once all preparatory work has been properly completed and all necessary precautionary measures have been taken, the pump is ready to start.

Before starting up the pump, check whether:

- Filling and venting lines are closed.
- The bearings are filled with the right amount of lubricant of the right type (if applicable).
- All protective devices (coupling guard, module cover etc.) are correctly attached and tightened.
- Pressure gauges with a suitable measurement range are installed on the suction and discharge side of the pump. Do not install the pressure gauges on the bends in the piping. The kinetic energy of the fluid can affect the measured values at these points.
- All blind flanges are removed.
- The shut-off device on the suction side of the pump is completely opened.
- The shut-off device in the pressure pipe of the pump is completely closed or only slightly opened.

**WARNING****Risk of injury due to high system pressure!**

The power and status of the installed centrifugal pumps must be constantly monitored.

- Do **not** connect pressure gauges to a pressurised pump.
- Install pressure gauges on the suction and discharge side.

**NOTICE**

It is recommended to attach a flow meter to determine the exact pump delivery rate.

- Switch on the pump: Restore power supply.
- After reaching the speed, slowly open the shut-off device in the pressure pipe and adjust the pump to the duty point.
- While the pump is starting, vent completely via the venting device.

CAUTION**Risk of material damage!**

If abnormal noises, vibrations, temperatures or leakages occur when starting up:

- Switch the pump off immediately and remedy the cause.

7.6 Behaviour after being switched on

During initial commissioning, the pump will work with the factory settings.

- The service menu is used for individual adjustment and re-setting of the pump; see section "Operation".
- To correct faults, also see section "Faults, causes and remedies".
- For additional information about the factory settings, see section "Factory settings".

CAUTION**Risk of material damage! Incorrect settings for the differential pressure sensor can cause malfunctions!**

Observe the recommended default values for the DPS used (for input In1).

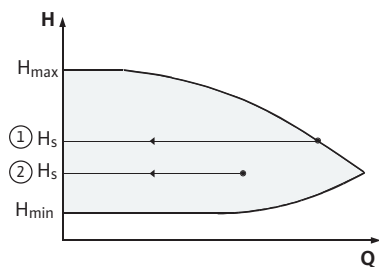
7.7 Setting the control mode

Fig. 32: Δp -c control

 Δp -c control

Setting	Δp -c
Duty point on maximum characteristic curve	Starting at the duty point, draw towards the left. Read off setpoint H_s and set pump to this value.
Duty point within the control range	Starting at the duty point, draw towards the left. Read off setpoint H_s and set pump to this value.
Setting range	H_{min} , H_{max} see characteristic curves (e.g. on data sheet)

Table 15: Δp -c control

**NOTICE**

Alternatively, constant speed or PID operating mode can also be set.

Constant speed

"Constant speed" mode deactivates all other control modes. The speed of the pump is kept to a constant value and set using the rotary knob. The speed range is dependent on the motor and pump type.

PID-Control

The PID controller is a standard PID controller, as described in control technology literature.

The PID controller determines the difference between the measured actual value and the desired setpoint (control deviation). It attempts to adjust the actual value to the setpoint by changing the pump speed via its output signal.

Various controls are possible with the appropriate sensors (e.g. pressure, differential pressure, temperature or flow control). When selecting a sensor, take note of the electrical values in the "Assignment of terminals" table.

The control behaviour can be optimised by adjusting the P, I and D parameters.

The proportional term (P term) of the controller amplifies the output signal of the controller directly and linearly. The sign before the P term determines the controller's direction of action.

The I term (I term) of the controller provides integral control based on the system deviation. A constant deviation results in a linear increase of the output signal until the set-

point is reached. The I-controller is an accurate but slow controller and leaves no permanent control deviation.

The differential term (D term) of the controller does not react to the control deviation, but only to its rate of change. This affects the rate at which the system responds. In the factory settings, the D term is set to zero as this is an appropriate setting for a number of applications.

Only change the parameters in small increments and continuously monitor the effects on the system. Only a specialist trained in control engineering may adjust the parameter values.

Control term	Factory setting	Setting range	Increment
P	0.5	-30.0 ... -2.0	0.1
		-1.99 ... -0.01	0.01
		0.00 ... 1.99	0.01
		2.0 ... 30.0	0.1
I	0.5 s	10 ms ... 990 ms	10 ms
		1 s ... 300 s	1 s
D	0 s (= deactivated)	0 ms ... 990 ms	10 ms
		1 s ... 300 s	1 s

Table 16: PID parameter

The sign before the P term determines the controller’s direction of action.

Positive PID-Control (default):

If the P term is positive and the process value drops below the setpoint, the control will increase the pump speed.

Negative PID-Control

If the P term is negative and the process value drops below the setpoint, the control will decrease the pump speed.



NOTICE

Possible malfunction if the PID control goes in the wrong direction!

The pump only runs at minimum or maximum speed. It does not react to changes in the parameter values.

- Check controller direction.

8 Operation
8.1 Operating elements

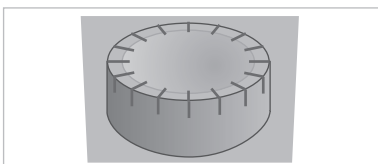


Fig. 33: Operating button

Settings are made by turning and pressing the operating button. Turn the operating button to the left or right to browse the menus or configure settings.

- Turning : Menu selection and parameter setting.
- Pressing : Activation of menus or confirming settings.

The DIP switches are located under the housing cover.

No.	Function
1	Switching between standard level and service mode. For additional information, see “Activate/Deactivate service mode” chapter
2	Activating or deactivating the access disable feature. For additional information, see “Activating/deactivating access disable” chapter
3 & 4	Terminating the “Multi Pump” communication. For additional information, see “Activate/Deactivate termination” chapter

Table 17: DIP switch

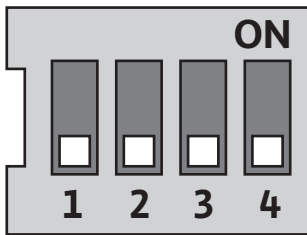


Fig. 34: DIP switch

8.2 Display structure

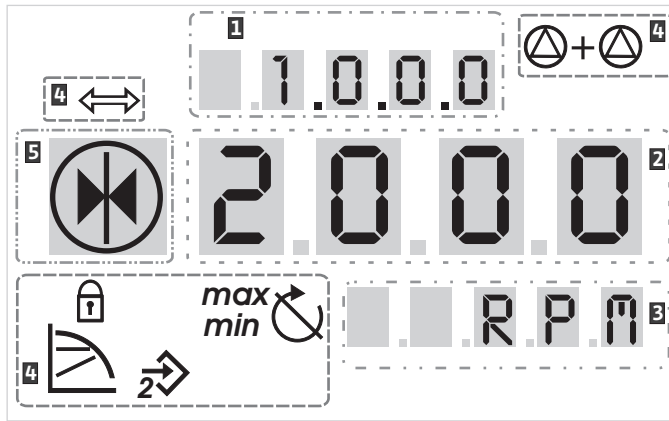


Fig. 35: Display structure

1	Menu number	2	Standard symbols
3	Value display	4	Symbol display
5	Units display		



NOTICE

The display can be rotated by 180°. To change it, see menu number <5.7.1.0>.

8.3 Explanation of standard symbols

The standard symbols are shown on the status display at the positions shown above:

Symbol	Description	Symbol	Description
	Constant speed control		Min operation
	Constant Δp-c control		Max. operation
	PID-Control		Pump is running
	Input In2 (external setpoint) activated		Pump stopped
	Access disable		Pump running in emergency operation (icon flashes)
	BMS (Building Management System) is active		Pump stopped in emergency operation (icon flashes)
	DP/MP operating mode: Parallel operation		DP/MP operating mode: Main/reserve

Table 18: Standard symbols of status display

8.4 Symbols in graphics/instructions

In the “Operating instructions” chapter, graphics are used to illustrate the operating concept and setting instructions.

The following symbols are used to simplify the display of menu elements or actions:

8.4.1 Menu elements



8.4.2 Actions



8.5 Display modes

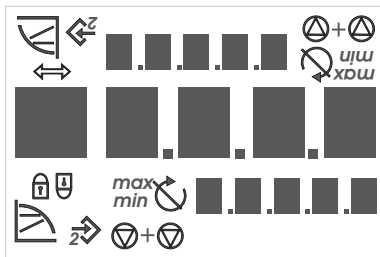


Fig. 36: Display test

- **Menu status page:** standard view on the display.
- **“One level down”:** A menu element with subordinate menu levels which you can switch to (e.g. <4.1.0.0> to <4.1.1.0>).
- **“Information”:** A menu element with information about the device status or settings that cannot be changed.
- **“Selection/setting”:** A menu element that provides access to a changeable setting (element with menu number <X.X.X.0>).
- **“Level up”:** A menu element with superordinate menu levels which you can switch to (e.g. <4.1.0.0> in <4.0.0.0>).
- **Menu error page:** In case of a fault, the current error number is displayed instead of a status page.
- **Turn the operating button:** Turn the operating button to increase or decrease settings or menu numbers.
- **Press the operating button:** Press the operating button to activate a menu element or confirm a change.
- **Navigate:** Follow the instructions below to navigate until the displayed menu number is reached.
- **Wait time:** The remaining time (in seconds) is displayed until the next state is reached automatically or a manual input can be made.
- **Set DIP switch to “OFF” position:** Set DIP switch number “X” under the housing cover to the “OFF” position.
- **Set DIP switch to “ON” position:** Set DIP switch number “X” under the housing cover to the “ON” position.

Display test

As soon as the electronic module has been supplied with power, a 2-second display test is carried out. All characters of the display are shown. Then the status page appears. After interruption of the power supply, the electronic module carries out various shut-off functions. The display will be shown for as long as this process continues.



DANGER

Risk of fatal injury due to electrical current! Electrical charge may still be present even if the display is switched off.

Coming into contact with live parts will result in death or serious injuries!

- Before working on the pump, disconnect the supply voltage and wait for 5 minutes.
- Check whether all connections (including potential-free contacts) are voltage-free.
- Never poke around in the openings on the electronic module and never insert anything into it!

8.5.1 Display status page



The standard view on the display is the status page. The current setpoint is displayed in the number segments. Other settings are displayed using symbols.



NOTICE

For twin-head pump operation, the status page additionally shows the operating mode (“parallel operation” or “main/reserve”) in the form of symbols. The display of the slave pump shows “SL”.

8.5.2 Display menu mode

The electronic module functions can be accessed via the menu structure. The menu contains sub-menus on several levels. A number is assigned to each menu and sub-menu.

The menu elements “Level up” or “Level down” are used to change the menu levels, e.g. from menu <4.1.0.0> to <4.1.1.0>.

The currently selected menu element is identified by the menu number on the display and the associated symbol.

Select menu numbers within a menu level sequentially by turning the operating button.



NOTICE

If the operating button is not operated for 30 seconds in menu mode, the display returns to the status page. In this case, no change is accepted.

“One level down” menu element



Every menu level can contain four different element types:

If the “Level down” arrow appears in the display, pressing the operating button switches to the next level down. After the change, the number of the new menu level increases by one digit (e.g. from menu <4.1.0.0> to menu <4.1.1.0>).

“Information” menu element



When this symbol appears, current settings or measurements cannot be changed (standard symbol for “Access disable”). The displayed information is read-only.

“Level up” menu element



When the “Level up” arrow appears in the display, pressing the operating button briefly switches to the next highest menu level (e.g. from menu <4.1.5.0> to menu <4.1.0.0>).



NOTICE

If the operating button is pressed for 2 seconds while the “Level up” arrow appears in the display, the display returns to the status display.

“Selection/setting” menu element



The “Selection/setting” symbol opposite does not appear in the display. The symbol indicates menu items in these instructions that allow selection or adjustment.

If a “Selection/setting” menu element is selected, pressing the operating button will change to edit mode.

In edit mode, the adjustable value flashes. Turning the operating button changes the value, pressing it again saves the value that has been set.



In some menus, after pressing the operating button, acceptance of the input will be confirmed by a brief display of the “OK” symbol.

8.5.3 Display error page



If an error occurs, the display changes from the status page to the error page. The display shows the letter “E” and the three-digit error code, separated by a decimal point.



Fig. 37: Error page (error status)

8.5.4 Menu groups

Basic menu

- <1.0.0.0>: Setpoint settings
- <2.0.0.0>: Operating mode setting
- <3.0.0.0>: “Pump on/off” setting

The menus show settings that may need to be changed during normal operation of the pump.

Info menu

- <4.0.0.0>: Pump parameter display

The menu <4.0.0.0> and its sub-menu elements show measuring data, device data, operating data and current statuses.

Service menu

- <5.0.0.0>: Access to pump parameter settings

The menu <5.0.0.0> and its sub-menu elements provide access to basic system settings for commissioning. The sub-elements are write-protected as long as service mode is not activated.

CAUTION

Risk of material damage!

Incorrect changes to settings can lead to pump operation errors, which in turn can lead to pump or system damage.

- Settings in service mode should only be made during commissioning and only by qualified personnel.
-

Error acknowledgement menu

- <6.0.0.0>: Error acknowledgement

If an error occurs, the display shows the error page. Pressing the operating button takes you from the error page to the error acknowledgement menu. After a waiting period has elapsed, pending fault messages can be acknowledged. For additional information, see “Acknowledging errors” chapter.

CAUTION

Risk of material damage!

Acknowledging faults without eliminating their cause can cause further faults. Material damage may occur to the pump or system.

- Only acknowledge errors after they have been rectified.
 - Only allow qualified personnel to rectify faults.
 - If in doubt, consult the manufacturer.
-

Access disable menu

For additional information, see “Faults, causes and remedies” chapter

- <7.0.0.0>: Access disable

The “access disable” feature is available when DIP switch 2 is set to ON. The menu cannot be reached via normal navigation.

Pressing the operating button activates or deactivates the access disable feature. The selection is confirmed by pressing the operating button.

8.6 Operating instructions

8.6.1 Adjusting the setpoint

The setpoint can be adjusted on the status page.

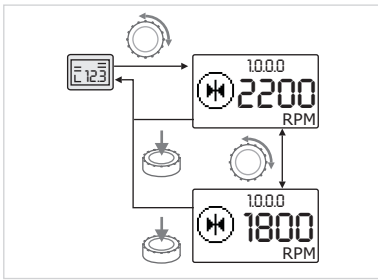


Fig. 38: Entering the setpoint

8.6.2 Changing to menu mode

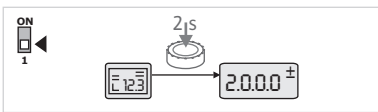


Fig. 39: Standard menu mode

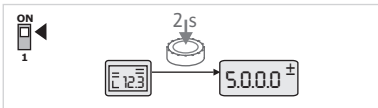


Fig. 40: Service mode menu

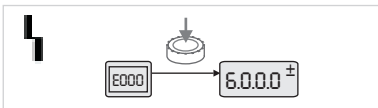





Fig. 41: Fault event mode menu

-  Turn the operating button.
The display changes to menu <1.0.0.0> and the setpoint starts flashing. Turning the operating button increases or decreases the setpoint.
-  To confirm the change, press the operating button.
The new setpoint will be accepted and the display will return to the status page.

To change to the menu mode:

-  While the display is showing the status page, press the operating button for 2 seconds (except in event of a fault).

Standard behaviour

The display changes to menu mode. Menu <2.0.0.0> is displayed.

Service mode

When service mode is activated (using DIP switch 1), menu <5.0.0.0> is displayed first.

Fault event

In the event of a fault, menu number <6.0.0.0> is displayed

8.6.3 Navigation

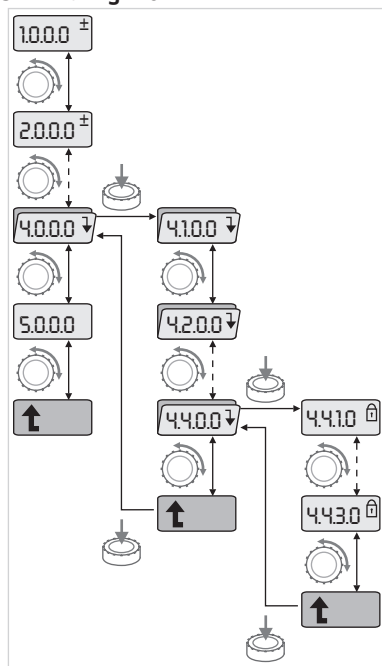






Fig. 42: Example navigation


→  Change to menu mode (see “Changing to menu mode” chapter).

 Carry out general menu navigation as follows (see example navigation): During navigation, the menu number flashes.

→  To select the menu element, turn the operating button.
The menu number is increased or decreased. The symbol of the menu element and the setpoint or actual value are shown if necessary.

If the downward-pointing arrow for “Level down” is displayed:

→  To change to the next menu level down, press the operating button.
The number of the new menu level is displayed, e.g. when changing from <4.4.0.0> to <4.4.1.0>. The symbols for the menu element and/or current value (setpoint, actual value or selection) are displayed.

→  To return to the next highest menu level, select the “Level up” menu element and press the operating button.
The number of the new menu level is displayed, e.g. when changing from <4.4.1.0> to <4.4.0.0>.



NOTICE

If the operating button is pressed for 2 seconds while a “Level up” menu element is selected, the display jumps back to the status page.

8.6.4 Changing selection/settings

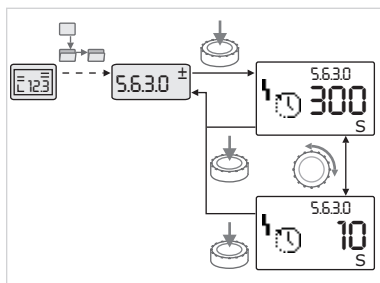






Fig. 43: Changing settings and returning to the “Selection/settings” menu element

To change a setpoint or a setting:

→  Navigate to the desired “Selection/settings” menu element.
The current value or status of the setting and the associated symbol are displayed.

→  Press the operating button. The symbol representing the setpoint or the setting flashes.

→  Turn the operating button until the desired setpoint or setting is displayed. For an explanation of the settings represented by the symbols, see table in the “Reference menu element” chapter.

→  Press the operating button again.

The selected setpoint or setting is confirmed, and the value or symbol stops flashing. The display is back in menu mode with the menu number unchanged. The menu number flashes.

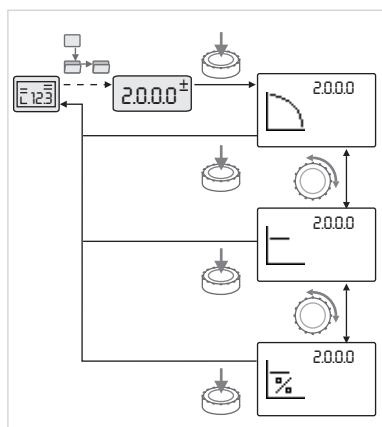


Fig. 44: Changing settings and returning to the status page

**NOTICE**

When values in <1.0.0.0>, <2.0.0.0> and <3.0.0.0>, <5.7.7.0> and <6.0.0.0> are changed, the display jumps back to the status page.

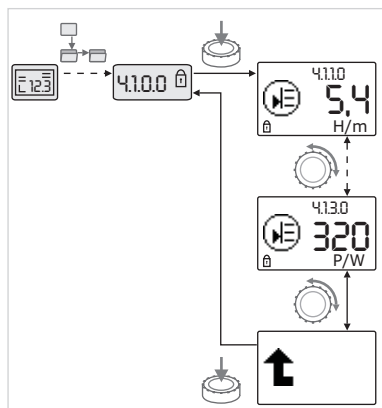
8.6.5 Accessing information

Fig. 45: Accessing information



Changes cannot be made in “Information” menu elements. These are indicated on the display by the default “access disable” symbol.

To access current settings:



→ Navigate to the desired “Information” menu element (<4.1.1.0> in the example).

The current value or status of the setting and the associated symbol are displayed. Pressing the operating button has no effect.



→ Turn the operating button to access the “Information” menu elements in the current sub-menu.

For an explanation of the settings represented by the symbols, see table in the “Reference menu element” chapter.



→ Turn the operating button until the “Level up” menu element is displayed.



→ Press the operating button.

The display returns to the next highest menu level (<4.1.0.0> here).

8.6.6 Activating/deactivating service mode

Additional settings can be made in service mode. The mode is activated or deactivated as follows.

CAUTION**Risk of material damage caused by changing the settings incorrectly!**

Incorrect changes to settings can lead to pump operation errors and cause damage to the pump or system.

- Settings in service mode should only be made during commissioning and only by qualified personnel.



→ Set DIP switch 1 to the “ON” position.

Service mode is activated. The symbol shown here flashes on the status page.



The sub-elements of menu <5.0.0.0> switch from the “Information” element type to the “Selection/setting” element type, and the standard “access disable” symbol (see symbol) is hidden for the relevant elements (except for <5.3.1.0>).

The values and settings for these elements can now be edited.



→ To deactivate, return the switch to its starting position.

8.6.7 Activating/deactivating access disable

In order to prevent inadmissible changes to the pump settings, all functions can be disabled.



When access is disabled, this is shown on the status page by the default “access disable” symbol.

To activate or deactivate:




→ Set DIP switch 2 to the “ON” position.


Menu <7.0.0.0> is displayed.




→ Turn the operating button to activate or deactivate the disable function.

→  To confirm the change, press the operating button.

Current status of disable function:


→  Disable active
No changes can be made to setpoints or settings. Read-only access to all menu elements is maintained.

→  Disable inactive: the elements of the basic menu can be edited (menu elements <1.0.0.0>, <2.0.0.0> and <3.0.0.0>).



NOTICE

To edit the sub-elements of menu <5.0.0.0>, service mode must also be activated.

→  Reset DIP switch 2 to the “OFF” position.
The display returns to the status page.




NOTICE

Errors can be acknowledged after a waiting period despite the “access disable” being active.

8.6.8 Activating/deactivating termination

In order to establish a definite communication connection between two electronic modules, it is necessary to terminate both ends of the cable.

To activate or deactivate:

→  Set DIP switches 3 and 4 to the “ON” position.
Termination is activated.



NOTICE

Both DIP switches must always be in the same position.

→  To deactivate, return the DIP switch to the starting position.

8.7 Menu elements reference


This chapter gives an overview of all elements at all menu levels. The menu number and the element type are designated separately, and the function of each element is explained. If applicable, there is information about the settings options of the individual elements.




































NOTICE

In certain situations, some elements are hidden. These are therefore skipped in the navigation of the menu.

























Example: If the external setpoint adjustment under menu <5.4.1.0> is set to “OFF”, menu number <5.4.2.0> will be hidden. Menu number <5.4.2.0> is only visible if the external setpoint adjustment in menu <5.4.1.0> is set to “ON”.

No.	Designation	Type	Symbol	Values/explanations	Display conditions
1.0.0.0	Setpoint	±		Setting/display of setpoint (for additional information, see “Adjusting the setpoint” chapter)	
2.0.0.0	Control mode	±		Setting/display of control mode (for additional information see “Control modes” and “Setting the control mode” chapters)	

No.	Designation	Type	Symbol	Values/explanations	Display conditions
				Constant speed control	
				Constant Δp -c control	
				PID-Control	
2.3.2.0	Δp -v gradient			Setting gradient of Δp -v (value in %)	Not displayed for all pump types
3.0.0.0	Pump on/off			ON Pump switched on	
				OFF Pump switched off	
4.0.0.0	Information			Information menus	
4.1.0.0	Actual values			Display of current actual values	
4.1.1.0	Actual values sensor (In1)			Depending on current control mode. Δp -c, Δp -v: Value H in m PID-Control: Value in %	Not displayed for constant speed
4.1.3.0	Power			Current power input P_1 in W	
4.2.0.0	Operating data			Display of operating data	The operating data refer to the electronic module currently being operated
4.2.1.0	Operating hours			The pump's total active operating hours (counter can be reset via infrared interface)	
4.2.2.0	Consumption			Energy consumption in kWh/MWh	
4.2.3.0	Pump cycling countdown			Time to pump cycling in hours (at a resolution of 0.1 h)	Shown only for twin-head pump master and internal pump cycling. Can be set in the service menu <5.1.3.0>
4.2.4.0	Remaining time until pump kick			Time until the next pump kick (after the pump has had a 24-hour standstill, e.g. via "External off", it will be automatically operated for 5 seconds)	Only displayed if pump kick is activated
4.2.5.0	"Mains on" counter			Number of times the supply voltage is switched on (each occasion the supply voltage is established after an interruption is counted)	
4.2.6.0	Pump kick counter			Number of pump kicks carried out	Only displayed if pump kick is activated
4.3.0.0	Statuses				
4.3.1.0	Base-load pump			The value display shows the identity of the regular base-load pump statically. The units display shows the identity of the temporary base-load pump statically.	Only displayed for twin-head pump master
4.3.2.0	SSM			ON Status of SSM relay if a fault message is present	

No.	Designation	Type	Symbol	Values/explanations	Display conditions
			   	<p>OFF</p> <p>Status of SSM relay if no fault message is present</p>	
4.3.3.0	SBM			<p>ON</p> <p>Status of SBM relay if a readiness/operation or "mains on" signal is present</p>	
				<p>OFF</p> <p>Status of SBM relay if no readiness/operation or "mains on" signal is present</p>	
			   	<p>SBM</p> <p>Run signal</p>	
			   	<p>SBM</p> <p>Readiness signal</p>	
				<p>SBM mains on signal</p>	
4.3.4.0	Ext. off		  	<p>Signal present at the "External off" input</p>	
			  	<p>OPEN</p> <p>Pump is switched off</p>	
			  	<p>SHUT</p> <p>Pump is enabled for operation</p>	
4.3.5.0	BMS protocol type			<p>Bus system active</p>	<p>Only displayed when BMS is active</p>
				<p>LON</p> <p>Field bus system</p>	<p>Only displayed when BMS is active</p>
				<p>CAN</p> <p>Field bus system</p>	<p>Only displayed when BMS is active</p>
				<p>Gateway Protocol</p>	<p>Only displayed when BMS is active</p>
4.3.6.0	AUX			<p>Status of "AUX" terminal</p>	
4.4.0.0	Device data			<p>Displays device data</p>	

No.	Designation	Type	Symbol	Values/explanations	Display conditions
4.4.1.0	Pump name		 12345	Example: GIGA-N 100/250-15/4 (display in ticker format)	Only the basic pump model appears on the display; version names are not shown
4.4.2.0	Software version of user controller		 12345	Displays the software version of the user controller	
4.4.3.0	Software version of motor controller		 12345	Displays the software version of the motor controller	
5.0.0.0	Service			Service menus	
5.1.0.0	Multi pump			Twin-head pump	Only displayed when DP is active (incl. sub-menus)
5.1.1.0	Operating mode			Main/standby operation	Only displayed for twin-head pump master
				Parallel operation	Only displayed for twin-head pump master
5.1.2.0	MA/SL setting			Manual switching from master to slave mode	Only displayed for twin-head pump master
5.1.3.0	Pump cycling				Only displayed for twin-head pump master
5.1.3.1	Manual pump cycling			Carries out pump cycling independent of countdown	Only displayed for twin-head pump master
5.1.3.2	Internal/external			Internal pump cycling	Only displayed for twin-head pump master
				External pump cycling	Shown only for twin-head pump master, see "AUX" terminal
5.1.3.3	Internal: time interval			Can be set between 8 hours and 36 hours in 4-hour steps	Displayed when internal pump cycling is activated
5.1.4.0	Pump enabled/disabled			Pump enabled	
				Pump disabled	
5.1.5.0				Individual fault signal	Only displayed for twin-head pump master
				Collective fault signal	Only displayed for twin-head pump master
5.1.6.0	SBM			Individual readiness signal	Only displayed for twin-head pump master and standby/operation SBM function
				Individual run signal	Only displayed for twin-head pump master
				Collective readiness signal	Only displayed for twin-head pump master
				Collective run signal	Only displayed for twin-head pump master
5.1.7.0	External off			Individual External off	Only displayed for twin-head pump master
				Collective External off	Only displayed for twin-head pump master
5.2.0.0	BMS			Settings for Building Management System (BMS) – building automation	Including all sub-menus, only displayed when BMS is active

No.	Designation	Type	Symbol	Values/explanations	Display conditions
5.2.1.0	LON/CAN/IF-Module Wink/Service	±		The wink function permits the identification of a device in the BMS network. A "wink" is executed by confirmation.	Only displayed when LON, CAN or IF module is active
5.2.2.0	Local/remote operation	±		BMS local operation	Temporary state, automatic reset to remote operation after 5 min
				BMS remote operation	
5.2.3.0	Bus address	±	#	Setting of bus address	
5.2.4.0	IF gateway val A	±		Specific settings of the IF module, depending on protocol type	Further information can be found in the installation and operating instructions of the IF modules
5.2.5.0	IF gateway val C	±			
5.2.6.0	IF gateway val E	±			
5.2.7.0	IF gateway val F	±			
5.3.0.0	In1 (sensor input)	↓		Settings for sensor input 1	Not displayed in constant speed mode (incl. all sub-menus)
5.3.1.0	In1 (sensor value range)			Display of sensor value range 1	Not displayed with PID-Control
5.3.2.0	In1 (value range)	±		Setting of value range; possible values: 0...10 V/ 2...10 V/0...20 mA/4...20 mA	
5.4.0.0	In2	↓			Setting for external setpoint input 2
5.4.1.0	In2 active/inactive	±		ON External setpoint input 2 active	
				OFF External setpoint input 2 inactive	
5.4.2.0	In2 (value range)	±		Setting of value range; possible values: 0...10 V/ 2...10 V/0...20 mA/4...20 mA	Not displayed when In2 = inactive
5.5.0.0	PID parameters	↓	PID	Settings for PID-Control	Only displayed when PID-Control is active (incl. all sub-menus)
5.5.1.0	P parameter	±		Setting of the proportional term of the control	
5.5.2.0	I parameter	±		Setting of the integral term of the control	
5.5.3.0	D parameter	±		Setting of the derivative term of the control	
5.6.0.0	Fault	↓		Settings for behaviour in the event of a fault	
5.6.1.0	HV/AC	±		HV ("heating") mode	
				AC ("cooling/air-conditioning") mode	
5.6.2.0	Emergency operation speed			Displays emergency operation speed	
5.6.3.0	Auto reset time	±		Time until automatic acknowledgement of an error	
5.7.0.0	Other settings 1	↓			

No.	Designation	Type	Symbol	Values/explanations	Display conditions
5.7.1.0	Display orientation			Display orientation	
				Display orientation	
5.7.2.0	Delivery head correction			When delivery head correction is enabled, the deviation from the differential pressure measured by the factory-fitted sensor on the pump flange is taken into account and corrected.	Only displayed in Δp -c mode. Not displayed for all pump variants
				Delivery head correction off	
				Delivery head correction on (factory setting)	
5.7.5.0	Switching frequency			HIGH High switching frequency (factory setting)	Switchover/change must only be carried out when the pump is at a standstill (not when motor is running)
				MID Medium switching frequency	
				LOW Low switching frequency	
5.7.6.0	SBM function			Settings for behaviour of signals	
				SBM run signal	
				SBM readiness signal	
				SBM mains on signal	
5.7.7.0	Factory setting			OFF (default setting): settings are not changed by confirming.	Not displayed when access disable is active. Not displayed when BMS is active.
				ON: confirming will reset the settings to factory settings. Caution! All manual settings will be lost.	Not displayed when access disable is active. Not displayed when BMS is active. For parameters that are changed by a factory setting, see "Factory settings" chapter.
5.8.0.0	Other settings 2				
5.8.1.0	Pump kick			ON (factory setting) Pump kick is activated	
5.8.1.1	Pump kick active/inactive				
				OFF Pump kick is deactivated	
5.8.1.2	Pump kick time interval			Can be set between 2 and 72 hours in 1-hour steps	Not displayed if pump kick is deactivated
5.8.1.3	Pump kick speed			Can be set between the pump's minimum and maximum speeds	Not displayed if pump kick is deactivated
6.0.0.0	Error acknowledgement			For additional information, see "Acknowledging errors" chapter.	Only displayed if an error is present.
7.0.0.0	Access disable			Access disable feature inactive (changes possible) (for additional information, see "Activating/deactivating access disable" chapter).	


No.	Designation	Type	Symbol	Values/explanations	Display conditions
				Access disable feature active (no changes possible) (for additional information, see "Activating/deactivating access disable" chapter)	

Table 19: Menu structure

9 Shutdown

9.1 Switching off the pump and temporary shutdown

CAUTION

Risk of material damage due to overheating!

Hot fluids can damage the pump seals when the pump is at a standstill.

After deactivating the heat source:

- Allow the pump to run until the fluid temperature has dropped to an appropriate level.

CAUTION

Risk of material damage due to frost!

If there is a danger of frost:

- Drain the pump completely to avoid damage.

- **Close** the shut-off device in the pressure pipe. If a non-return valve is installed in the pressure pipe and counterpressure is present, the shut-off device can remain open.
- Do **not** close the shut-off device in the suction line.
- Switch off the pump.
- If there is no danger of frost, make sure the fluid level is sufficient.
- Operate the pump every month for 5 minutes. Doing this prevents deposits from occurring in the pump compartment.

9.2 Shutdown and storage



WARNING

Risk of injury and damage to property!

- Dispose of the pump contents and rinsing fluid by taking the legal regulations into account.
- Always wear protective clothing, protective gloves and protective goggles when working.

- Clean the pump thoroughly prior to storage!
- Drain the pump completely and rinse thoroughly.
- The remaining fluid and rinsing fluid should be drained, collected and disposed of via the drain plug. Observe local regulations along with the notes under "Disposal"!
- Spray the interior of the pump with a preservative through the suction and discharge ports.
- Close the suction and discharge ports with caps.
- Grease or oil the blank components. For this, use silicone-free grease or oil. Observe the manufacturer's instructions for preservatives.

10 Maintenance/repair

It is recommended to have the pump serviced and checked by the Wilo customer service.

Maintenance and repair work require the pump to be partially or completely dismantled. The pump housing can be installed in the piping.

**DANGER****Risk of fatal injury due to electrical current!**

Improper conduct when carrying out electrical work can lead to death due to electric shock!

- Any work on electrical devices may only be carried out by a qualified electrician.
- Before carrying out any work, disconnect the unit from the power supply and secure it against accidental switch-on.
- Any damage to the pump connection cable should only ever be rectified by a qualified electrician.
- Observe the installation and operating instructions for the pump, motor and other accessories.
- Never poke around in the electronic module or motor openings or insert anything into them.
- Never operate the pump without the electronic module being installed.
- Reinstall any uninstalled safety devices, such as module or coupling covers, once the work is complete.

**WARNING****Sharp edges on the impeller!**

Sharp edges can form on the impeller. There is danger of limbs being severed! Protective gloves must be worn to protect against cuts.

10.1 Personnel qualifications

- Electrical work: A qualified electrician must carry out the electrical work.
- Maintenance tasks: The technician must be familiar with the use of operating fluids and their disposal. In addition, the technician must have basic knowledge of mechanical engineering.

10.2 Operation monitoring**CAUTION****Risk of material damage!**

Improper operation can damage the pump or motor. Operating with the shut-off device closed is not recommended and generally dangerous in the case of hot fluids. The pump must not be allowed to operate dry for more than **1 minute**. Dry running causes a build-up of energy in the pump, producing heat which can damage the shaft, impeller, and mechanical seal.

- Never allow the pump to run without fluid.
- Do not operate the pump with the shut-off device in the suction line closed.
- Do not operate the pump for a longer period of time with the shut-off device in the pressure pipe closed. This can cause the fluid to overheat.

The pump must run quietly and vibration-free at all times.

The rolling bearings must run quietly and vibration-free at all times.

Increased current consumption with unchanged operating conditions is a sign of bearing damage. The bearing temperature may be up to 50°C above the ambient temperature, but never rise above 80°C.

- Check the static gaskets and the shaft seal regularly for leakages.
- For pumps with mechanical seals, there is little to no visible leakage during operation. If a gasket is leaking significantly, this is a sign that the gasket surfaces are worn. The gasket must be replaced. The service life of a mechanical seal greatly depends on the operating conditions (temperature, pressure, fluid properties).
- Wilo recommends checking the flexible coupling elements regularly and replacing them at the first sign of wear.
- Wilo recommends briefly operating the standby pumps at least once a week to ensure they are always ready for operation.

10.3 Maintenance tasks

The bearing bracket of the pump is equipped with rolling bearings which have lifetime lubrication.

- The rolling bearings of the motors are to be maintained according to the installation and operating instructions of the motor manufacturer.
- Check the air supply to the motor housing at regular intervals. Dirt impairs the cooling of the motor and electronic module. If necessary, remove dirt and restore unrestricted air supply.

10.4 Draining and cleaning



WARNING

Risk of injury and damage to property!

- Dispose off the pump contents and rinsing fluid by taking the legal regulations into account.
- Always wear protective clothing, protective gloves and protective goggles when working.

10.5 Dismantling



DANGER

Risk of fatal injury due to electrical current!

Improper conduct when carrying out electrical work can lead to death due to electric shock!

- Any work on electrical devices may only be carried out by a qualified electrician.
- Before carrying out any work, disconnect the unit from the power supply and secure it against accidental switch-on.
- Any damage to the pump connection cable should only ever be rectified by a qualified electrician.
- Observe the installation and operating instructions for the pump, motor and other accessories.
- Never poke around in the electronic module or motor openings or insert anything into them.
- Never operate the pump without the electronic module being installed.
- Reinstall any uninstalled safety devices, such as module or coupling covers, once the work is complete.

Maintenance and repair work require the pump to be partially or completely dismantled. The pump housing can be installed in the piping.

1. Switch off the energy supply to the pump and secure against accidental switch-on.
2. Close all valves in the suction line and pressure pipe.
3. Drain the pump by opening the drainage screw and the venting device.
4. Ensure system is voltage-free.
5. Earth the work area and short-circuit.
6. Disconnect the mains cable. If present, remove the cable for the differential pressure sensor.
7. If required, remove additional cables (sensors, signals etc.).
8. Remove coupling guard.
9. If present: Remove the intermediate sleeve of the coupling.
10. Remove the fastening screws of the motor from the baseplate.



NOTICE

Observe the section drawing in the section "Spare parts".

10.5.1 Dismantling the slide-in unit

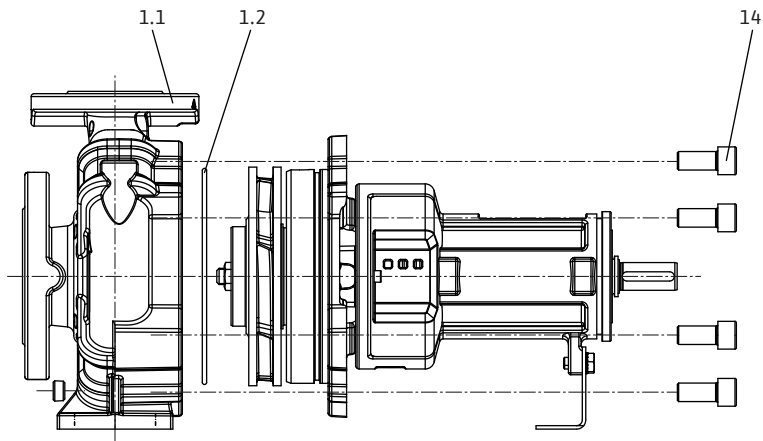


Fig. 46: Removing the slide-in unit

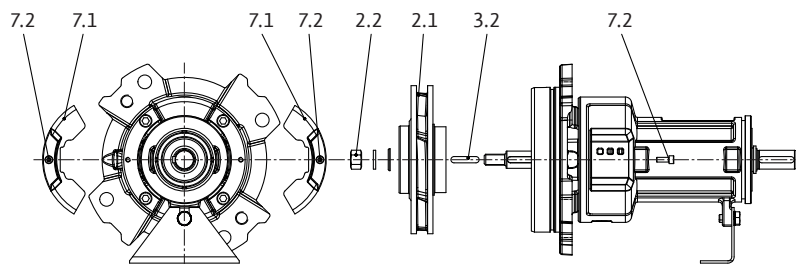


Fig. 47: Dismantling the slide-in unit

1. Mark positions of the parts that belong together with a coloured pen or scribe.
2. Remove the hexagon head screws (14).
3. Carefully pull the slide-in unit straight out of the spiral housing (1.1) to avoid damage to interior parts.
4. Put the slide-in unit down at a safe workplace. To continue dismantling the slide-in unit, fix it **vertically** in position with the drive shaft facing downward. The kit must be removed vertically to avoid damage to the impellers, neck rings and other parts.
5. Remove the housing seal (1.2).
6. Remove the hexagon head screws (7.2) and remove the protective grid (7.1).
7. Loosen the impeller nut (2.2) and remove along with the lock washer and impeller disc.

Version with mechanical seal (optional: mechanical seal on the sleeve)

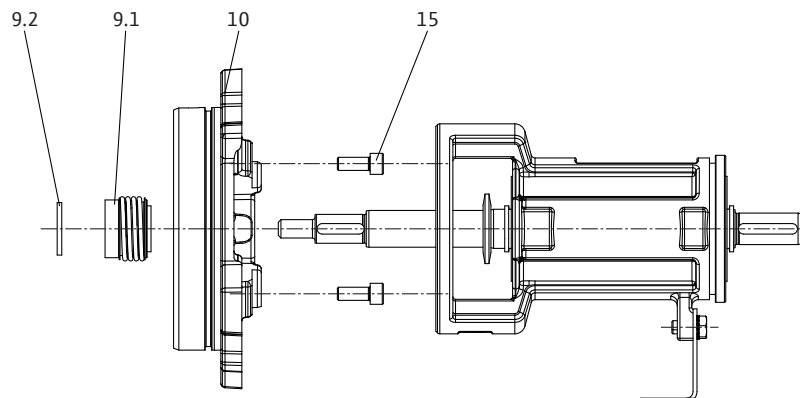


Fig. 48: Version with mechanical seal

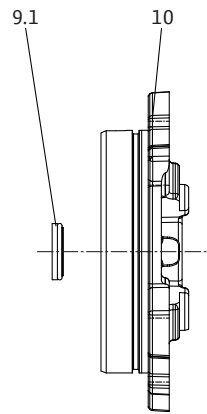


Fig. 49: Housing cover, mechanical seal

1. Remove the spacer (9.2).
2. Remove the rotating part of the mechanical seal (9.1).
3. Loosen the interior hexagonal head screws (15) and remove the housing cover (10).
4. Remove the stationary part of the mechanical seal (9.1).

10.5.2 Dismantling the bearing bracket

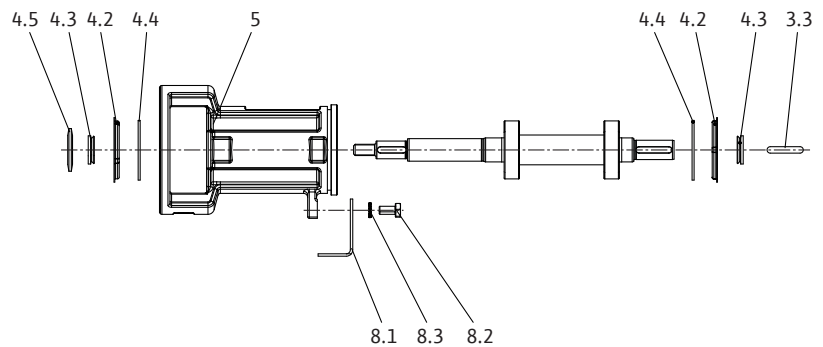


Fig. 50: Bearing bracket

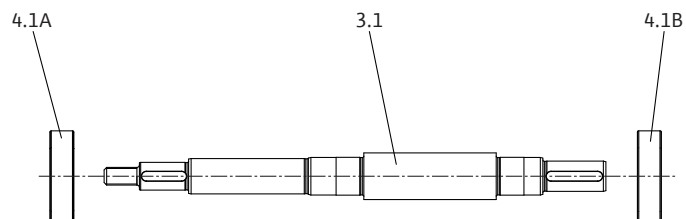


Fig. 51: Shaft

1. Remove the key (3.3).
2. Pull off the thrower (4.5) and V-gaskets (4.3).
3. Remove the bearing cover (4.2) and retaining ring (4.4).
4. Loosen the hexagon head screw (8.2), remove the lock washer (8.3) and remove the pump support foot (8.1).
5. Completely remove the shaft (3.1) from the bearing bracket (5).
6. Remove the ball bearings (4.1A and 4.1B) from the shaft (3.1).

Neck rings

The pump is optionally equipped with exchangeable neck rings. During operation, the gap backlash increases due to wear. The period of use of the rings depends on the operating conditions. If the volume flow decreases and the motor shows signs of increased current consumption, this could be caused by an impermissibly high gap backlash. In this case, replace the neck rings.

10.5.3 Dismantling the electronic module



DANGER

Risk of fatal injury due to electrical current!

Improper conduct when carrying out electrical work can lead to death due to electric shock!

- Any work on electrical devices may only be carried out by a qualified electrician.
- Before carrying out any work, disconnect the unit from the power supply and secure it against accidental switch-on and wait 5 minutes.
- Check whether all connections (including potential-free contacts) are voltage-free.
- Never poke around in the openings on the electronic module or insert anything into them.
- Any damage to the pump connection cable should only ever be rectified by a qualified electrician.
- Observe the installation and operating instructions for the pump, motor and other accessories.
- Reinstall any uninstalled safety devices, such as module covers, once the work is complete.



DANGER

Risk of fatal injury due to contact voltage! Even when it is disconnected, high contact voltages can still occur in the electronic module due to non-discharged capacitors.

Touching live parts will result in serious injuries or death!

- Before working on the pump, disconnect the power supply and wait for 5 minutes.
- Check whether all connections (including potential-free contacts) are voltage-free.
- Never poke around in the openings of the electronic module or insert anything into them!

Dismantling, module 1.5 ... 7.5 kW

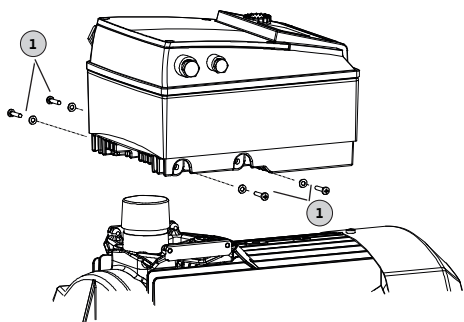


Fig. 52: Replacing the electronic module

1. Disconnect the system from the power supply and secure it against being switched on again without authorisation.
2. Close the shut-off devices upstream and downstream of the pump.
3. Ensure system is voltage-free.
4. Earth the work area and short-circuit.
5. Disconnect the mains cable. If present, remove the cable for the differential pressure sensor.
6. If required, remove additional cables (sensors, signals etc.).
7. Remove the screws and tooth lock washers (Item 1) and pull the electronic module vertically upwards.

CAUTION

Risk of material damage if the electronic module is not installed!

Normal operation of the pump is only permitted with the electronic module installed!

The pump must not be connected or operated without the electronic module being installed!

Dismantling, module 11 ... 22 kW

**NOTICE**

The electronic module must be dismantled and installed according to the instructions enclosed with the spare part!

CAUTION**Risk of material damage due to lack of ventilation of the electronic module!**

For motor power of ≥ 11 kW, the electronic module has a built-in speed-controlled fan for cooling. The fan switches on automatically if the heat sink reaches 60 °C. The fan draws in air from the outside, which is guided over the outer surface of the heat sink. It only runs when the electronic module is operated under load. Depending on the prevailing ambient conditions, dust is sucked in by the fan, which can accumulate in the heat sink.

- Check the electronic modules from 11 kW for contamination at regular intervals.
- Clean fan and heat sink if required.

10.6 Installation

Installation must be carried out based on the detailed drawings in the section “Dismantling” as well as the general drawings in the section “Spare parts”.

- Clean and check the single components for wear before installation. Damaged or worn parts must be replaced with original spare parts.
- Coat location points with graphite or something similar before installation.
- Check the O-rings for damage and replace if necessary.
- Flat gaskets must be constantly replaced.

**DANGER****Risk of fatal injury due to electrical current!**

Improper conduct when carrying out electrical work can lead to death due to electric shock!

- Any work on electrical devices may only be carried out by a qualified electrician.
- Before carrying out any work, disconnect the unit from the power supply and secure it against accidental switch-on.
- Any damage to the pump connection cable should only ever be rectified by a qualified electrician.
- Observe the installation and operating instructions for the pump, motor and other accessories.
- Never poke around in the electronic module or motor openings or insert anything into them.
- Never operate the pump without the electronic module being installed.
- Reinstall any uninstalled safety devices, such as module or coupling covers, once the work is complete.

**NOTICE**

Observe the drawings in the section “Spare parts”.

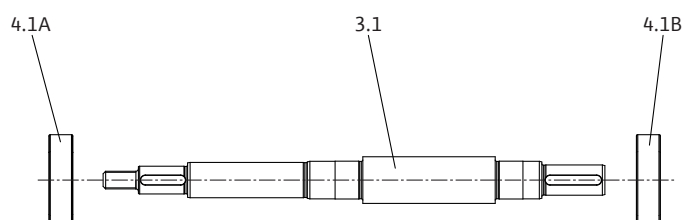
10.6.1 Installing the shaft/bearing bracket

Fig. 53: Shaft

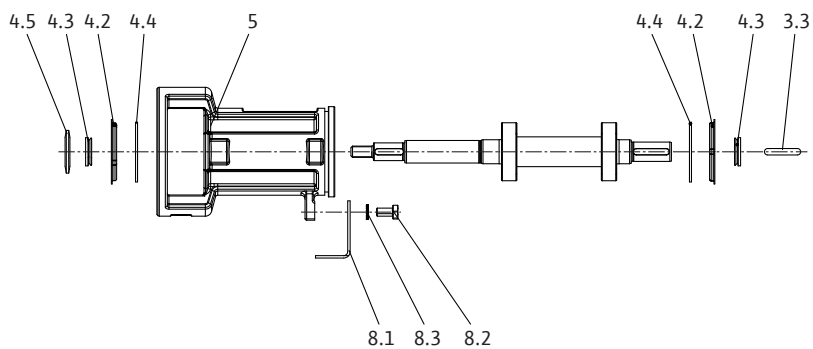


Fig. 54: Bearing bracket

1. Press the ball bearings (4.1A and 4.1B) onto the shaft (3.1).
2. Push the shaft (3.1) into the bearing bracket (5).
3. Insert the retaining rings (4.4) into the groove and the bearing cover (4.2) into the drilled hole of the bearing bracket (5).
4. Push the V-gaskets (4.3) and thrower (4.2) onto the shaft (3.1).
5. Insert the key (3.3) into the shaft nut.
6. Fasten the pump support foot (8.1) with the hexagon head screw (8.2) and lock washer (8.3).

Neck rings

The pump is optionally equipped with exchangeable neck rings. During operation, the gap backlash increases due to wear. The period of use of the rings depends on the operating conditions. If the volume flow decreases and the motor shows signs of increased current consumption, this could be caused by an impermissibly high gap backlash. In this case, replace the neck rings.

10.6.2 Assembling the slide-in unit

Version with mechanical seal (optional: mechanical seal on the sleeve)

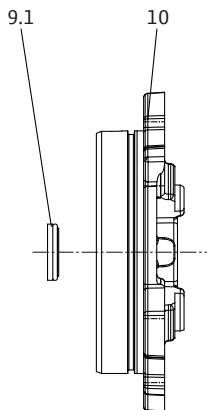


Fig. 55: Housing cover, mechanical seal

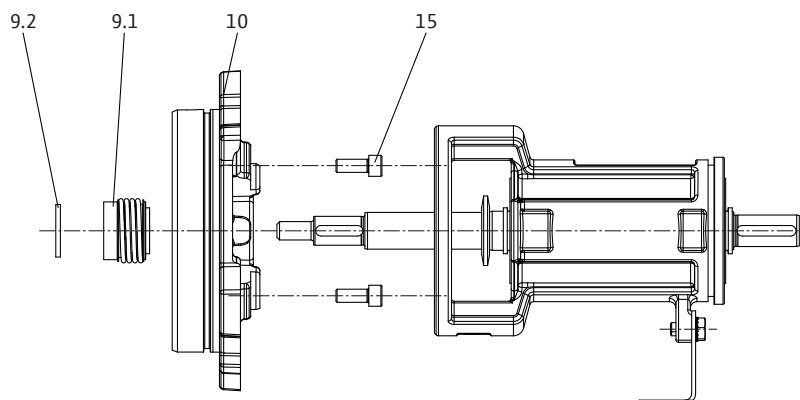


Fig. 56: Version with mechanical seal

1. Clean the stationary ring seat in the housing cover.
2. Insert the stationary part of the mechanical seal (9.1) carefully into the housing cover (10).
3. Optional: Push the sleeve onto the shaft.
4. Screw the housing cover (10) onto the bearing bracket with the interior hexagonal head screws (15).
5. Push the rotating part of the mechanical seal (9.1) onto the shaft (optional: sleeve).
6. Push the spacer (9.2) onto the shaft.

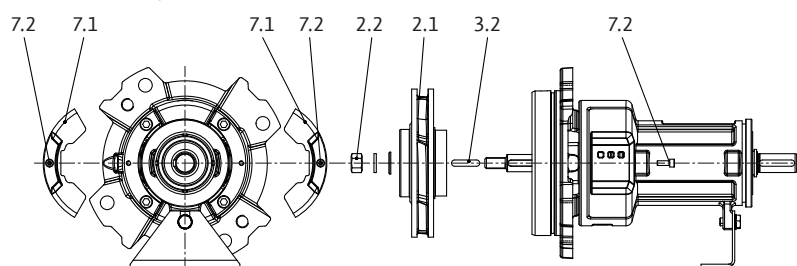


Fig. 57: Fitting the slide-in unit

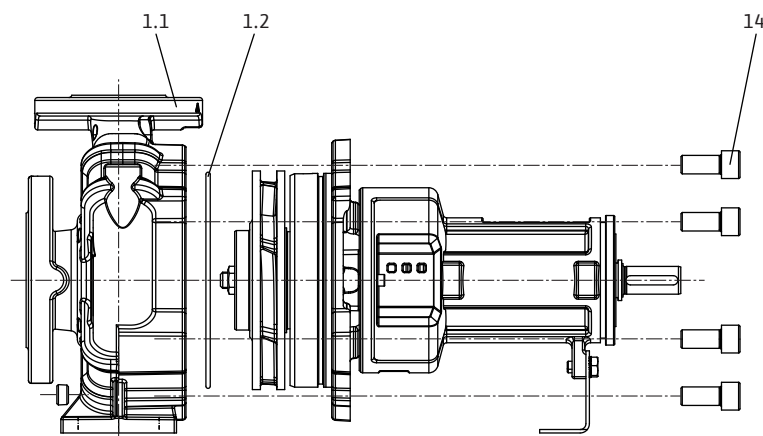


Fig. 58: Inserting the slide-in unit

1. Mark positions of the parts that belong together with a coloured pen or scribe.
2. Mount the impeller disc, impeller (2.1) and key(s) (3.2) on the shaft and tighten with the impeller nut (2.2).
3. Mount the protective grid (7.1) with interior hexagonal head screws (7.2).
4. Put the slide-in unit down at a safe workplace. To continue dismantling the slide-in unit, fix it **vertically** in position with the drive shaft facing downward. The kit must be removed vertically to avoid damage to the impellers, neck rings and other parts.
5. Insert a new housing seal (1.2).
6. Carefully insert the slide-in unit into the spiral housing (1.1) and tighten with the hexagonal head screws (14).

10.6.3 Installing the electronic module



DANGER

Risk of fatal injury due to electrical current!

Improper conduct when carrying out electrical work can lead to death due to electric shock!

- Any work on electrical devices may only be carried out by a qualified electrician.
- Before carrying out any work, disconnect the unit from the power supply and secure it against accidental switch-on and wait 5 minutes.
- Check whether all connections (including potential-free contacts) are voltage-free.
- Never poke around in the openings of the electronic module or insert anything into them!
- Any damage to the pump connection cable should only ever be rectified by a qualified electrician.
- Observe the installation and operating instructions for the pump, motor and other accessories!
- Reinstall any uninstalled safety devices, such as module covers, once the work is complete!

Installation, module 1.5 ... 7.5 kW

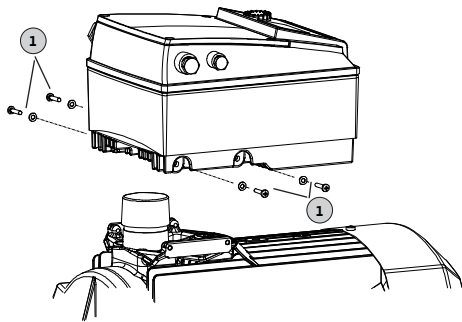


Fig. 59: Electronic module – motor connection

1. Earth the work area and short-circuit. Disconnect the mains cable. If present, remove the cable for the differential pressure sensor.
2. Fit the new O-ring between the electronic module and the motor on the contacting chamber.
3. Press the electronic module vertically downwards into the contact of the motor and fasten with screws and the tooth lock washers (Item 1).
4. Remove the module cover.
5. Connect the mains cable.
6. If present, connect the differential pressure sensor cable.
7. For all other cable connections, see the “Electrical Connection” section.
8. Carefully close and tighten the module cover.
9. For cable connections and securing the module cover, please also see the “Screw tightening torques for electronic module” table.

Ensure that no drips can run into the electronic module:

- Bend the cables into a drain loop near the threaded cable gland
- Unused cable glands should be sealed with the sealing washers provided and screwed tight.

CAUTION

Risk of material damage if the electronic module is not installed!

Normal operation of the pump is only permitted with the electronic module installed!

The pump must not be connected or operated without the electronic module being installed!

Installation, module 11 ... 22 kW



NOTICE

The electronic module must be dismantled and installed according to the instructions enclosed with the spare part!

CAUTION**Risk of material damage due to lack of ventilation of the electronic module!**

For motor power of ≥ 11 kW, the electronic module has a built-in speed-controlled fan for cooling. The fan switches on automatically if the heat sink reaches 60 °C. The fan draws in air from the outside, which is guided over the outer surface of the heat sink. It only runs when the electronic module is operated under load. Depending on the prevailing ambient conditions, dust is sucked in by the fan, which can accumulate in the heat sink.

- Check the electronic modules from 11 kW for contamination at regular intervals.
- Clean fan and heat sink if required.

Component	Thread	Tightening torque [Nm] $\pm 10\%$	Installation information
Control terminals	–	0.5	
Power terminals	–	1.5 ... 7.5 kW: 0.5 11 ... 22 kW: 1.3	
Earth terminals	–	0.5	
Electronic module – motor (tie bolts)	–	4.0	
Module cover	1.5 ... 7.5 kW: M4 11 ... 22 kW: M6	1.5 ... 7.5 kW: 0.8 11 ... 22 kW: 4.3	
Threaded cable gland union nut	M12x1.5 M16x1.5 M20x1.5 M25x1.5 M40x1.5	3.0 6.0 8.0 11.0 16	1x threaded cable gland M12 reserved for connecting cable for an optional differential pressure sensor

Table 20: Screw tightening torques for electronic module

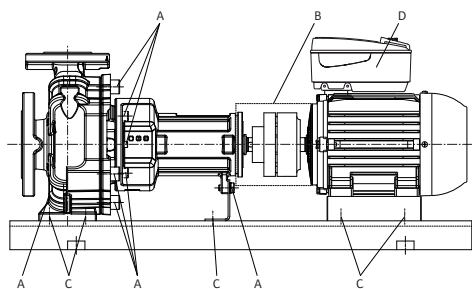
10.6.4 Screw tightening torques

Fig. 60: Screw tightening torques, unit

When tightening the screws, use the following tightening torques.

→ A (pump)

Thread:	M8	M10	M12	M16	M20	M24
Tightening torque [Nm]	25	35	60	100	170	350

Table 21: Screw tightening torque A (pump)

→ B (coupling): refer to “Tightening torques for adjusting screws and coupling halves” table in “Coupling alignment” chapter.

→ C (baseplate): refer to “Tightening torques for pump and motor” table in “Alignment of the pump unit” chapter.

→ D (electronic module): 5 Nm, see also “Screw tightening torques for electronic module” table in “Installing the electronic module” chapter

11 Spare parts

Spare parts may be ordered via a local installer and/or Wilo customer service. List of original spare parts: Refer to the Wilo spare parts documentation and the following information in these installation and operating instructions.

CAUTION

Risk of material damage!

Trouble-free pump operation can only be guaranteed when original spare parts are used.

Use only original Wilo spare parts!

Information to be provided when ordering spare parts: spare part numbers, spare part names/descriptions, all data from the pump and rating plate. This helps prevent return queries and incorrect orders.

11.1 Spare parts list

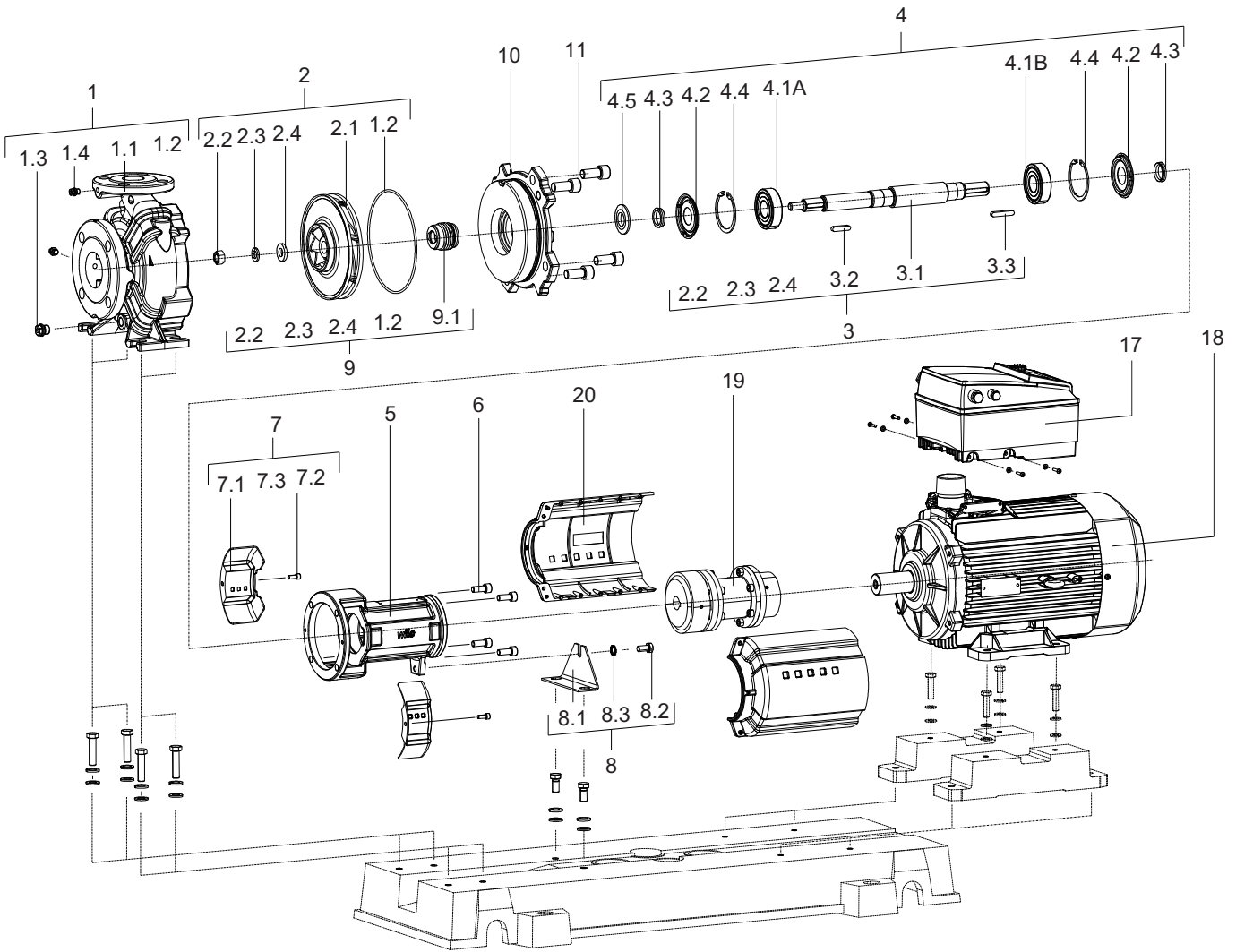


Fig. 61: Pump with mechanical seal

Item no.	Description	Number	Safety-relevant
1.1	Pump housing	1	
1.2	O-ring	1	X
1.3	Screw	1	
1.4	Screw	1	
2.1	Impeller	1	
2.2	Nut	1	
2.3	Disc	1	
2.4	Disc	1	
3.1	Shaft	1	
3.2	Key	1	

Item no.	Description	Number	Safety-relevant
3.3	Key	1	
4.1A	Ball bearing	1	X
4.1B	Ball bearing	1	X
4.2	Cover	1	
4.3	V-gasket	1	
4.4	Retaining ring	1	
4.5	Thrower	1	
5	Bearing bracket housing	1	
6	Screw	4	
7.1	Shaft protection kit	2	
7.2	Screw	2	
8.1	Supporting foot	1	
8.2	Screw	1	
8.3	Disc	1	
9.1	Mechanical seal	1	X
9.2	Disc	1	
10	Discharge cover	1	
11	Screw	4	
17	Electronic module	1	
18	Motor	1	
19	Coupling	1	
20	Coupling guard	1	

Table 22: Spare parts list, version with mechanical seal

12 Faults, causes and remedies



DANGER

Risk of death due to electrocution!

Improper conduct when carrying out electrical work can lead to death due to electric shock! Electrical work must be carried out by a qualified electrician in accordance with the locally applicable regulations.



WARNING

No persons are allowed to be present inside the working area of the pump!

Persons may suffer (serious) injuries while the pump is in operation! No persons may therefore be present inside the working area. If persons must enter the working area of the pump, the pump must be decommissioned and secured against being switched on again without authorisation.



WARNING

Sharp edges on the impeller!

Sharp edges can form on the impeller. There is danger of limbs being severed! Protective gloves must be worn to protect against cuts.

Further steps for troubleshooting

If the points listed here do not rectify the fault, contact customer service. Customer service can assist in the following ways:

- Telephone or written support.
- On-site support.
- Inspection and repair at the factory.

Costs may be incurred if you request customer services! Please contact customer services for more information.

Fault indications

For faults, causes and remedies, see the “Fault/warning message” flow diagram in the “Acknowledging errors” chapter and the following tables. The first column of the table lists the code numbers displayed in the event of a fault.



NOTICE

Some faults resolve themselves automatically if the cause of the fault is no longer present.

Key

The following types of errors can occur with differing priorities (1 = lowest priority; 6 = highest priority):

Error type	Description	Priority
A	A fault is present; the pump stops immediately. The fault must be acknowledged at the pump.	6
B	A fault is present; the pump stops immediately. The counter is increased and a timer counts down. After the 6th error event, the error becomes a final fault. The fault must be acknowledged at the pump.	5
C	A fault is present; the pump stops immediately. If the fault persists for more than 5 minutes, the counter is increased. After the 6th error event, the error becomes a final fault. The fault must be acknowledged at the pump. Otherwise the pump restarts automatically.	4
D	The same as fault type A, but with lower priority.	3
E	Emergency operation: warning with emergency operation speed and activated SSM	2
F	Warning – pump continues to run	1

Table 23: Error types

12.1 Mechanical faults

Error index	Description
1	Delivery rate too low
2	Bearing temperature too high
3	Pump housing leakage
4	Shaft seal leakage
5	Pump does not run smoothly or is loud
6	Pump temperature too high

Table 24: Error index

1	2	3	4	5	6	Cause	Remedy
X						Counterpressure too high	<ul style="list-style-type: none"> – Check system for contaminants – Reset the duty point
X				X	X	Pump and/or piping not completely filled	<ul style="list-style-type: none"> – Vent pump and fill suction line
X				X	X	Inlet pressure too low or negative suction head too high	<ul style="list-style-type: none"> – Correct the fluid level – Minimise resistances in the suction line – Clean filter – Reduce negative suction head by installing the pump lower

1	2	3	4	5	6	Cause	Remedy
X			X			Sealing gap too large due to wear	– Exchange worn neck ring
X						Incorrect direction of rotation	– Change the motor connection phases
X						Pump sucks air or suction line is leaky	– Replace gasket – Check suction line
X						Supply line or impeller clogged	– Remove clogging
X						Pump blocked by loose or jammed parts	– Clean pump
X						Air pockets in the piping	– Change the pipe layout or install an air vent valve
X						Speed too low – with frequency converter operation – without frequency converter operation	– Increase frequency in the permissible range – Check voltage
				X		Counter pressure of the pump too low	– Readjust the duty point or adjust the impeller
						The viscosity or density of the fluid is higher than the design specification	– Check the pump dimensioning (consult with the manufacturer)
	X		X	X	X	The pump is strained	Correct the pump installation
	X		X	X		Pump unit poorly aligned	– Correct alignment
	X					Thrust too high	– Clean the relief bores in the impeller – Check the condition of the neck rings
	X					Bearing lubrication not sufficient	Check bearing, exchange bearing
	X					Coupling distance not maintained	– Correct the coupling distance
	X			X	X	– Flow rate too low	– Maintain recommended minimum flow rate
		X				– Housing screws not correctly tightened or gasket defective	– Check tightening torque – Replace gasket
			X			Leak in mechanical seal	– Replace mechanical seal
			X	X		Impeller imbalance	– Rebalance impeller
				X		Bearing damage	– Replace bearing
				X		Foreign object in pump	– Clean pump
					X	Pump is pumping against a closed shut-off valve	– Open shut-off valve in pressure pipe

Table 25: Causes of error and remedies

12.2 Error codes, display

Classification	No.	Fault	Cause	Remedy	Error type	
					HV	AC
–	0	No error				

Classification	No.	Fault	Cause	Remedy	Error type	
System errors	E004	Undervoltage	Mains over-loaded	Check electrical installation	C	A
	E005	Overvoltage	Mains voltage too high	Check electrical installation	C	A
	E006	2-phase operation	Missing phase	Check electrical installation	C	A
	E007	Warning! Generator operation (flow in flow direction)	The flow is driving the pump impeller; electrical current is being fed back to the mains	Check the setting; check system for proper operation Caution! Prolonged operation can cause damage to the electronic module	F	F
Pump errors	E010	Blocking	Shaft is mechanically blocked	If the blocking has not been remedied after 10 seconds, the pump switches off. Check shaft for ease of movement, contact customer service	A	A
Motor errors	E020	Excess temperature in winding	Motor over-loaded	Allow motor to cool off, check settings, check/correct duty point	B	A
			Motor ventilation restricted	Provide unobstructed air access		
			Water temperature too high	Lower water temperature		
	E021	Motor overload	Duty point outside duty chart	Check/correct duty point	B	A
			Deposits in the pump	Contact customer service		
	E023	Short circuit/earth leakage	Motor or electronic module defective	Contact customer service	A	A
	E025	Faulty contact	Electronic module has no contact to motor	Contact customer service	A	A
Winding interrupted		Motor faulty	Contact customer service			
E026	WSK or PTC interrupted	Motor faulty	Contact customer service	B	A	

Classification	No.	Fault	Cause	Remedy	Error type	
Electronic module error	E030	Excess electronic module temperature	Restricted air supply to heat sink of electronic module	Provide unobstructed air access	B	A
	E031	Hybrid/power section excess temperature	Ambient temperature too high	Improve room ventilation	B	A
	E032	Intermediate circuit undervoltage	Voltage fluctuations in the mains	Check electrical installation	F	D
	E033	Intermediate circuit overvoltage	Voltage fluctuations in the mains	Check electrical installation	F	D
	E035	DP/MP: multiple instances of same identity	Multiple instances of same identity	Reallocate master and/or slave (see "Twin-head pump installation/Y-pipe installation" chapter)	E	E
Communication errors	E050	BMS communication timeout	Bus communication interrupted or timed out, cable breakage	Check cable connection to building automation	F	F
	E051	Impermissible DP/MP combination	Different pumps	Contact customer service	F	F
	E052	DP/MP communication time-out	MP communication cable defective	Check cable and cable connections	E	E

Classification	No.	Fault	Cause	Remedy	Error type	
Electronics errors	E070	Internal communication error (SPI)	Internal electronics error	Contact customer service	A	A
	E071	EEPROM error	Internal electronics error	Contact customer service	A	A
	E072	Power section/frequency converter	Internal electronics error	Contact customer service	A	A
	E073	Impermissible electronic module number	Internal electronics error	Contact customer service	A	A
	E075	Charging relay defective	Internal electronics error	Contact customer service	A	A
	E076	Internal transformer defective	Internal electronics error	Contact customer service	A	A
	E077	24 V operating voltage for differential pressure sensor defective	Differential pressure sensor defective or connected incorrectly	Check differential pressure sensor connection	A	A
	E078	Impermissible motor number	Internal electronics error	Contact customer service	A	A
	E096	Infobyte not set	Internal electronics error	Contact customer service	A	A
	E097	Flexpump data record missing	Internal electronics error	Contact customer service	A	A
	E098	Flexpump data record invalid	Internal electronics error	Contact customer service	A	A
	E121	Motor PTC short-circuit	Internal electronics error	Contact customer service	A	A
	E122	Interruption to NTC power element	Internal electronics error	Contact customer service	A	A
	E124	Interruption to NTC electronic module	Internal electronics error	Contact customer service	A	A
Impermissible combinatorics	E099	Pump type	Different pump types have been interconnected	Contact customer service	A	A

Table 26: Error codes

Additional explanations of error codes

Error E021:

Error “E021” indicates that the pump requires more power than is permitted. To ensure that the motor and electronic module do not suffer irreparable damage, the drive protects itself by switching the pump off if an overload lasts more than 1 minute. The most common causes of this error are a pump type of too small dimensions, especially when pumping viscous fluids, or an excessive volume flow in the system. When this error code is displayed, there is not an error in the electronic module.

Error E070; possibly combined with error E073:

If additional signal or control cables are connected to the electronic module, the effects of EMC (immission/interference resistance) may interrupt communication. This results in error code “E070” being displayed.

You can check this by disconnecting all communication cables installed by the customer in the electronic module. If the fault no longer occurs, there may be an external

12.3 Acknowledge fault

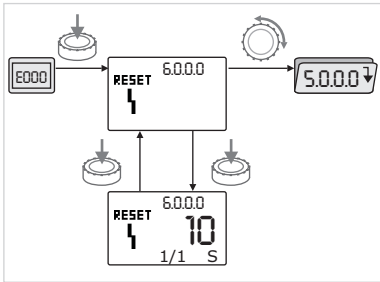


Fig. 62: Navigation in the event of an error

interference signal on the communication lines that exceeds the applicable standard values. The pump can only return to normal operation once the source of interference is remedied.



In the event of a fault, the error page is displayed instead of the status page.

You can then navigate as follows:



→ To change to the menu mode, press the operating button. Menu number <6.0.0.0> flashes on the display. By turning the operating button, it is possible to navigate in the menu as usual.



→ Press the operating button. Menu number <6.0.0.0> is displayed without flashing. On the units display, the current incidence (x) as well as the maximum incidence of the error (y) are displayed in the format "x/y". Until the error can be acknowledged, pressing the operating button again will cause a return to menu mode.



NOTICE

A 30-second timeout causes the display to revert to the status page or error page. Each error code has a separate error counter that counts all incidences of the error within the last 24 hours. The error counter is reset manually, 24 hours after "Mains ON" or when "Mains ON" is repeated.

12.3.1 Error type A or D

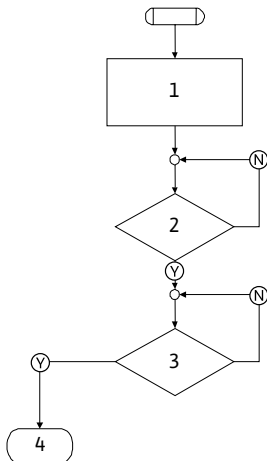


Fig. 63: Error type A, diagram

Program step/query	Contents
1	<ul style="list-style-type: none"> → Error code is displayed → Motor Off → Red LED On → SSM is activated → Error counter is increased
2	> 1 min?
3	Error acknowledged?
4	End; auto control resumes
Y	Yes
N	No

Table 27: Error type A

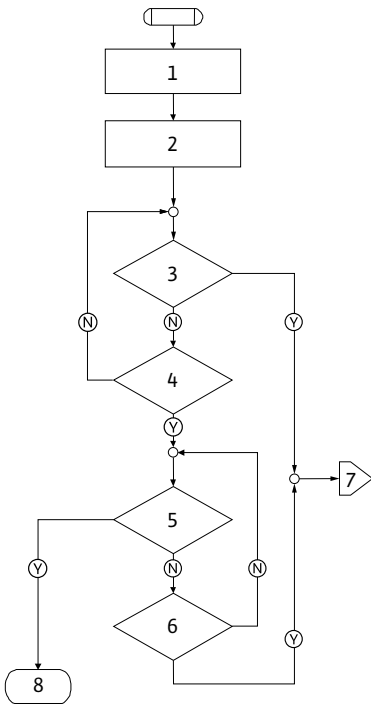


Fig. 64: Error type D, flowchart

Program step/query	Contents
1	→ Error code is displayed → Motor Off → Red LED On → SSM is activated
2	→ Error counter is increased
3	Is there a new type "A" fault?
4	> 1 min?
5	Error acknowledged?
6	Is there a new type "A" fault?
7	Branching to error type "A"
8	End; auto control resumes
(Y)	Yes
(N)	No

Table 28: Error type D

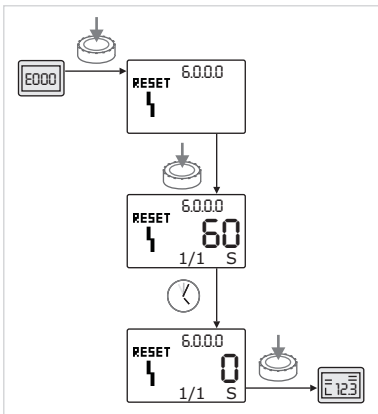


Fig. 65: Acknowledging error type A or D

Acknowledging error types A or D:

- To change to menu mode, press the operating button. Menu number <6.0.0.0> flashes on the display.
- Press the operating button again. Menu number <6.0.0.0> is displayed without flashing. The time remaining before the error can be acknowledged is displayed.
- Wait until the remaining time is up. The waiting time before manual acknowledgement is always 60 seconds for error types A and D.
- Press the operating button again. The error is acknowledged, and the status page is displayed.

12.3.2 Error type B

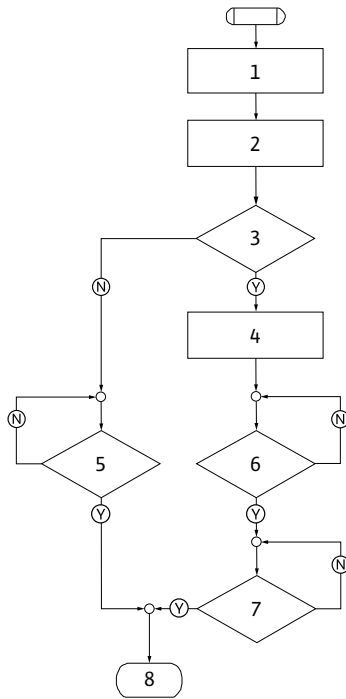


Fig. 66: Error type B, flowchart

Program step/query	Contents
1	→ Error code is displayed → Motor Off → Red LED On
2	→ Error counter is increased
3	Error counter > 5?
4	→ SSM is activated
5	> 5 min?
6	> 5 min?
7	Error acknowledged?
8	End; auto control resumes
(Y)	Yes
(N)	No

Table 29: Error type B

Acknowledging error type B:



→

To change to menu mode, press the operating button. Menu number <6.0.0.0> flashes on the display.



→

Press the operating button again. Menu number <6.0.0.0> is displayed without flashing.

The units display shows the current incidence (x) as well as the maximum incidence of the error (y) in the format "x/y".

If the current incidence of the error is less than the maximum incidence:



→

Wait for auto reset time.

The value display shows the remaining time until auto reset of the error in seconds. After the auto reset time has run out, the error will be automatically acknowledged and the status page will be displayed.

Incidence X < Y

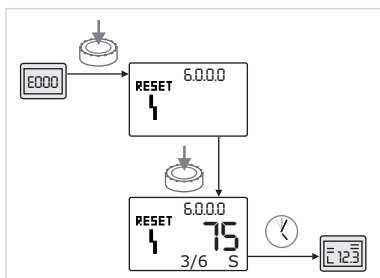


Fig. 67: Acknowledging error type B (X < Y)



NOTICE

The auto reset time can be set in menu number <5.6.3.0> (time input 10 to 300 seconds).

Incidence X = Y

If the current incidence of the error is equal to the maximum incidence:



→

Wait until the remaining time is up.

The time until manual acknowledgement is always 300 seconds. On the value display, the remaining time until manual acknowledgement of the error is displayed in seconds.



→

Press the operating button again. The error is acknowledged, and the status page is displayed.

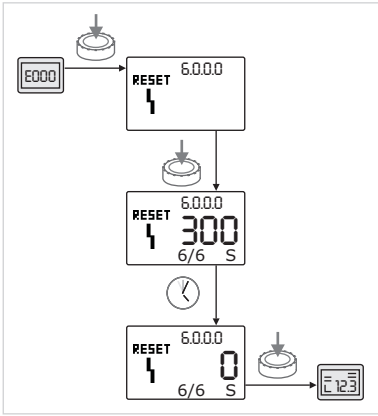


Fig. 68: Acknowledging error type B (X = Y)

12.3.3 Error type C

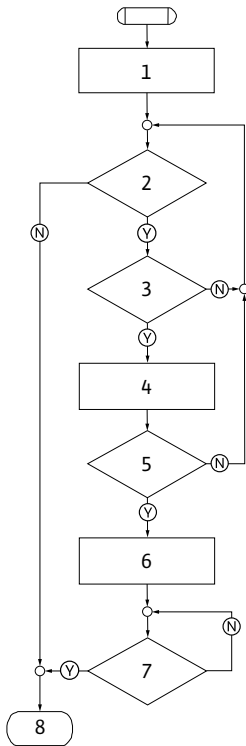


Fig. 69: Error type C, flowchart

Program step/query	Contents
1	→ Error code is displayed → Motor Off → Red LED On
2	Error criterion fulfilled?
3	> 5 min?
4	→ Error counter is increased
5	Error counter > 5?
6	→ SSM is activated
7	Error acknowledged?
8	End; auto control resumes
Ⓨ	Yes
Ⓝ	No

Table 30: Error type C

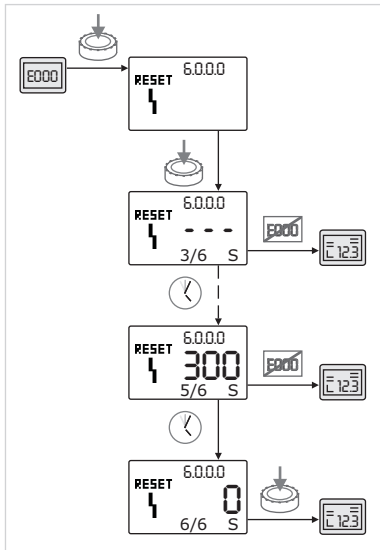


Fig. 70: Acknowledging error type C

Acknowledging error type C:



To change to menu mode, press the operating button. Menu number <6.0.0.0> flashes on the display.



Press the operating button again. Menu number <6.0.0.0> is displayed without flashing.

The graphics show “- - -”.

The units display shows the current incidence (x) as well as the maximum incidence of the error (y) in the format “x/y”. After 300 seconds, the figure for current incidence will increase by one



NOTICE

The error will be acknowledged automatically if the cause of the error is eliminated.



Wait until the remaining time is up.

If the current incidence (x) is the same as the maximum incidence of the error (y), the error can be acknowledged manually.



Press the operating button again. The error is acknowledged, and the status page is displayed.

12.3.4 Error type E or F

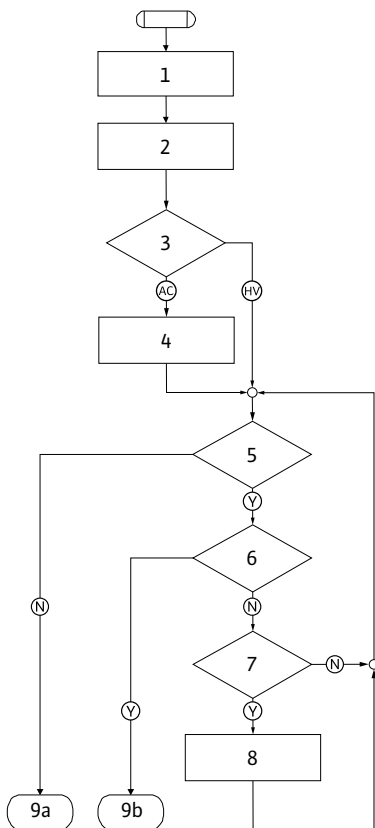


Fig. 71: Error type E, flowchart

Program step/query	Contents
1	→ Error code is displayed → Pump goes into emergency operation
2	→ Error counter is increased
3	Error matrix AC or HV?
4	→ SSM is activated
5	Error criterion fulfilled?
6	Error acknowledged?
7	Error matrix HV and > 30 min?
8	→ SSM is activated
9a	End; auto control (twin-head pump) re-sumes
9b	End; auto control (single pump) resumes
Ⓨ	Yes
Ⓝ	No

Table 31: Error type E

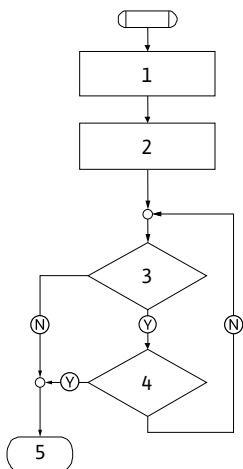


Fig. 72: Error type F, flowchart

Program step/query	Contents
1	→ Error code is displayed
2	→ Error counter is increased
3	Error criterion fulfilled?
4	Error acknowledged?
5	End; auto control resumes
Ⓨ	Yes
Ⓝ	No

Table 32: Error type F

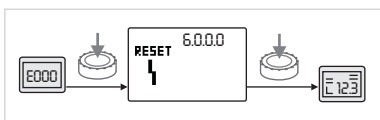


Fig. 73: Acknowledging error type E or F

Acknowledging error type E or F:



→ To change to menu mode, press the operating button. Menu number <6.0.0.0> flashes on the display.



→ Press the operating button again. The error is acknowledged, and the status page is displayed.



NOTICE

The error will be acknowledged automatically if the cause of the error is eliminated.

13 Factory settings

Menu no.	Designation	Factory-configured values
1.0.0.0	Setpoints	<ul style="list-style-type: none"> → Constant speed: approx. 60 % of n_{\max} pump → Δp-c: approx. 50 % of H_{\max} pump → Δp-v: approx. 50 % of H_{\max} pump
2.0.0.0	Control mode	Δp -c activated
2.3.3.0	Pump	ON
4.3.1.0	Base-load pump	MA
5.1.1.0	Operating mode	Main/standby operation
5.1.3.2	Internal/external pump replacement	internal
5.1.3.3	Pump cycling time interval	24 h
5.1.4.0	Pump enabled/disabled	Approved
5.1.5.0	SSM	Collective fault signal
5.1.6.0	SBM	Collective run signal
5.1.7.0	External off	Collective External off
5.3.2.0	In1 (value range)	0–10 V active
5.4.1.0	In2 active/inactive	OFF
5.4.2.0	In2 (value range)	0–10 V
5.5.0.0	PID parameter	See “Setting the control mode” chapter
5.6.1.0	HV/AC	HV
5.6.2.0	Emergency operation speed	approx. 60 % of n_{\max} pump
5.6.3.0	Auto reset time	300 sec
5.7.1.0	Display orientation	Display on original orientation
5.7.2.0	Pressure value correction	active
5.7.6.0	SBM function	SBM: Run signal
5.8.1.1	Pump kick active/inactive	ON
5.8.1.2	Pump kick interval	24 h
5.8.1.3	Pump kick speed	n_{\min}

Table 33: Factory settings

14 Disposal

14.1 Oils and lubricants

Operating fluid must be collected in suitable tanks and disposed of in accordance with the locally applicable guidelines (e.g. 2008/98/EC).

14.2 Water-glycol mixture

The operating fluid complies with Water Hazard Class 1 of the German Administrative Regulation of Substances Hazardous to Water (VwVwS). When disposing of it, the locally applicable guidelines (e.g. DIN 52900 on propanediol and propylene glycol) must be observed.

14.3 Protective clothing

Used protective clothing must be disposed of in accordance with the locally applicable guidelines (e.g. 2008/98/EC).

14.4 Information on the collection of used electrical and electronic products

Proper disposal and appropriate recycling of this product prevents damage to the environment and putting your personal health at risk.



NOTICE**Disposal in domestic waste is prohibited!**

In the European Union this symbol may be included on the product, the packaging or the accompanying documentation. It means that the electrical and electronic products in question must not be disposed of along with domestic waste.

Please note the following points to ensure proper handling, recycling and disposal of the used products in question:

- Hand over these products at designated, certified collection points only.
- Observe the locally applicable regulations!

Please consult your local municipality, the nearest waste disposal site, or the dealer who sold the product to you for information on proper disposal. See www.wilo-recycling.com for more information about recycling.

Subject to change without prior notice!



wilo

Pioneering for You



Local contact at
www.wilo.com/contact

WILO SE
Wilopark 1
44263 Dortmund
Germany
T +49 (0)231 4102-0
T +49 (0)231 4102-7363
wilo@wilo.com
www.wilo.com